

ZEAFIVE®

ASSEMBLY INSTRUCTIONS BATHROOM VANITY TOP

MODEL.
FO-60W



PRODUCT
INSTRUCTION
VIDEO

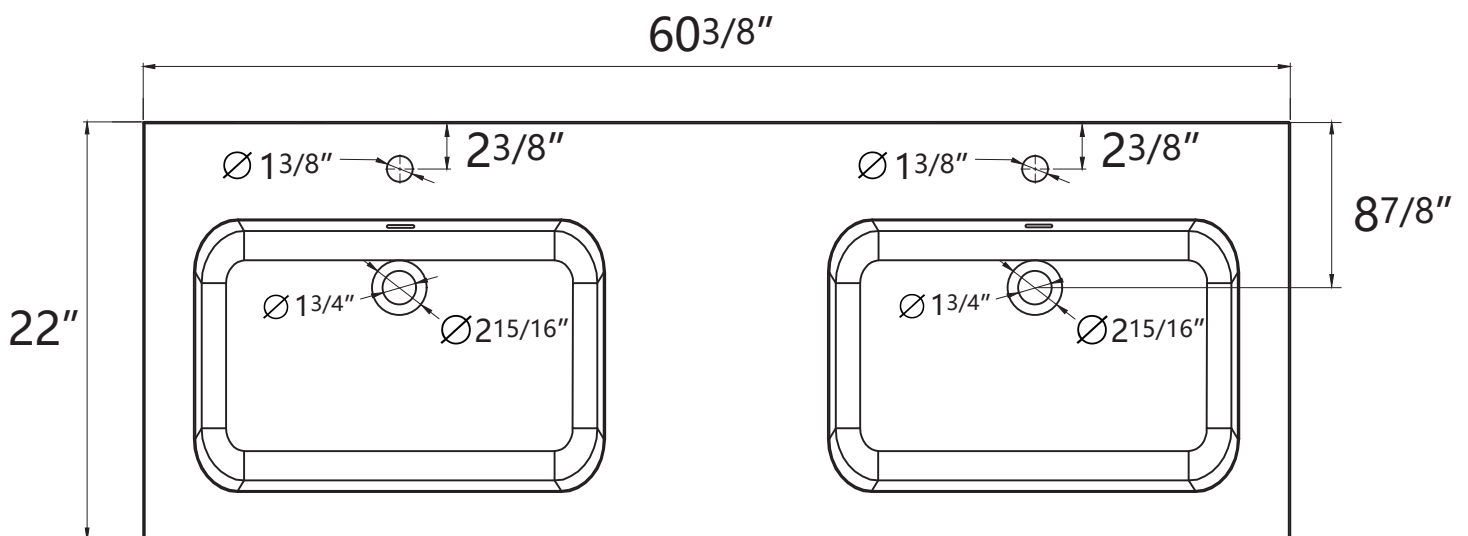



NOTE: Any size of the vanity's installation steps are the same.

INSTALLATION STEPS

1. Prepare the Vanity: Make sure the vanity is in place and securely attached to the wall.

2. Seal the Edges: To prevent water damage and ensure a clean finish, apply a bead of silicone caulk along the edges where the countertop meets the vanity.

(For Example)

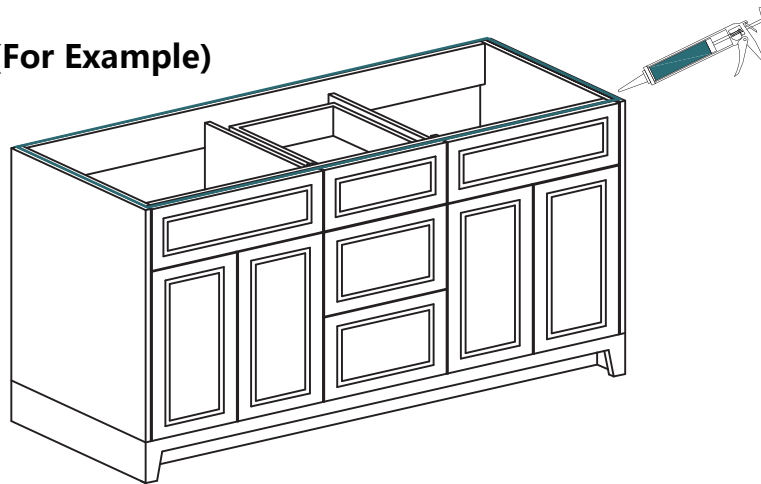

3. Attach the Countertop: Secure the solid surface countertop on the vanity.

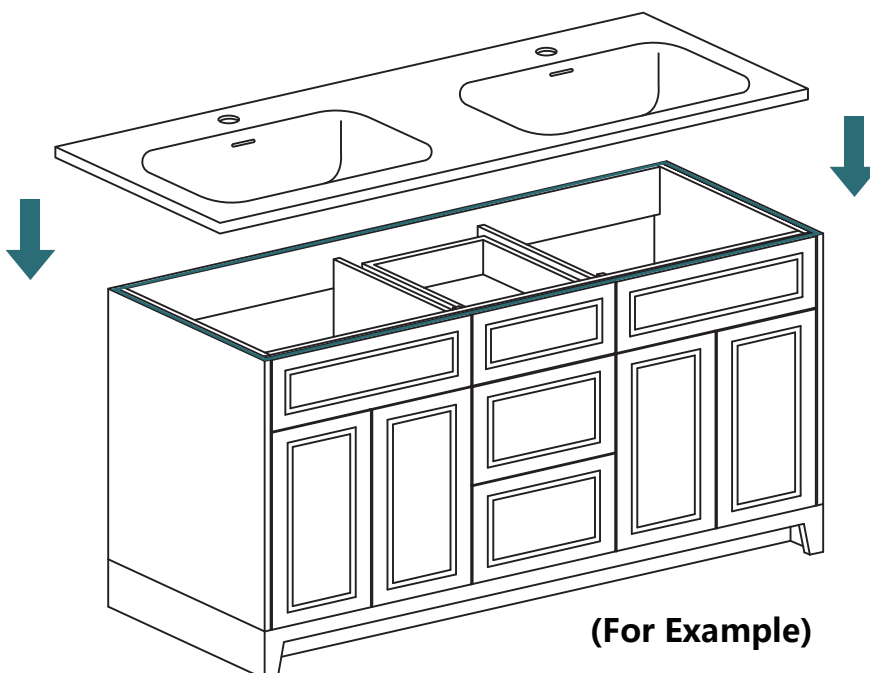



HOME SERVICES



INSTALLATION VIDEO

Missing Part or Defective?

Please Contact the Customer Service Team

 service@bestgosupplychaininc.com