

ASSEMBLY INSTRUCTIONS

Dining Set - Chair

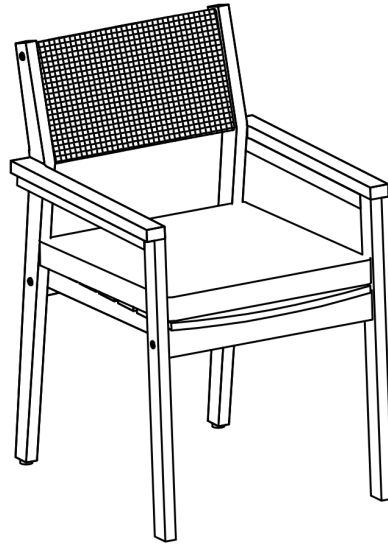

MAINTAINANCE INSTRUCTIONS

TO STORE:

Place unit in its box or safety dry and cool place. Avoid putting chair in contact with sharp edges or pointed objects which might cut or puncture the fabric. Do not wrap attached power cord around the unit.

Do not pull the unit by power cord.

ASSEMBLY INSTRUCTIONS

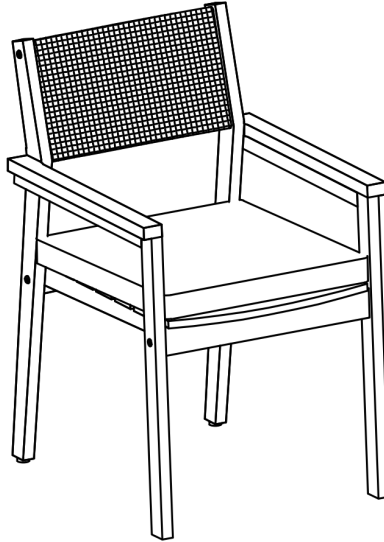



GENERAL ASSEMBLY INFORMATION GUIDE

Please read the following instructions prior to assembling this product:

1. To avoid damage, assemble this product on a non-abrasive surface such as carpet.
2. Make sure all bolts are tightly fastened before use.
3. For home use or light commercial use only.
4. Please make sure you have all parts before assembly.

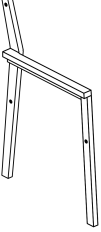
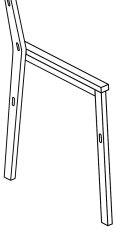
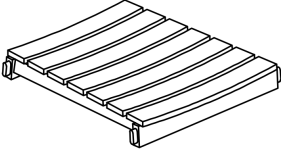
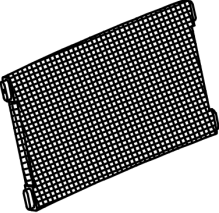
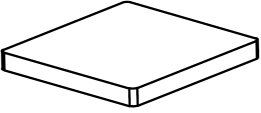
PARTS LIST

A	Left Arm	B	Right Arm	C	Seat
					
QTY 3 pcs		QTY 3 pcs		QTY 3 pcs	
D	Backrest	E	Cushion		
					
QTY 3 pcs		QTY 3 pcs			

F	Screw M7x70	G	Allen wrench
			
QTY 18 pcs		QTY 3 pcs	

- ① Assemble the Armrest (A, B), seat (C), and backrest (D) with tenon joints
- ② Fix with screws (F)

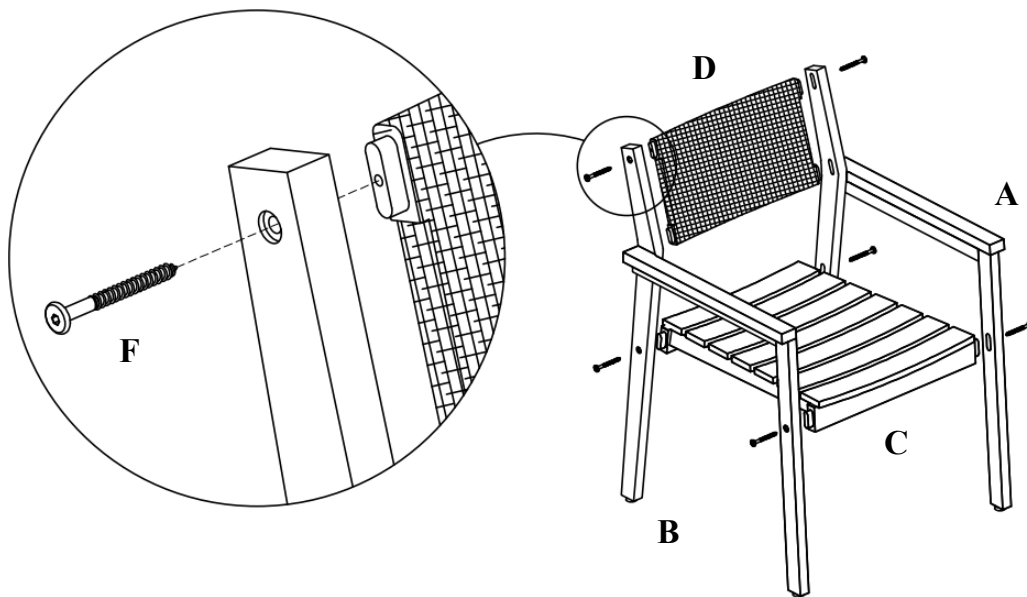

- ③ Place the Cushion (E) on and tie the rope to secure the cushion

