

ASSEMBLY INSTRUCTIONS INSTRUCTIONS DE MONTAGE INSTRUCCIONES DE MONTAJE









WOOD BENCH W/BACK KD









CAUTION: PLEASE READ ALL INSTRUCTIONS BEFORE STARTING THE ASSEMBLY OF THIS PRODUCT. THESE PIECES ARE HEAVY. IN ORDER TO PREVENT PERSONAL INJURY AND ENSURE THAT THIS PRODUCT IS NOT DAMAGED DURING THE ASSEMBLY PROCESS, IT IS STRONGLY RECOMMENDED TO ENLIST THE ASSISTANCE OF ONE OR MORE PERSONS. IN CASE OF EXCESS STAIN, WIPE THE BOTTOM OF THE UNIT BEFORE PLACING ON ANY SURFACE.

ATTENTION: VEUILLEZ LIRE TOUTES LES INSTRUCTIONS AVANT DE COMMENCER L'ASSEMBLAGE DE CE PRODUIT. LES PIÈCES SONT LOURDES. POUR ÉVITER TOUTE BLESSURE ET POUR VOUS ASSURER QUE LE PRODUIT N'EST PAS ENDOMMAGÉ PENDANT L'ASSEMBLAGE, NOUS VOUS RECOMMANDONS DE FAIRE APPEL À UNE OU PLUSIEURS AUTRES PERSONNES. EN CAS DE TACHE EXCESSIVE, ESSUYEZ LE FOND DE L'UNITÉ AVANT LE PLACEMENT SUR N'IMPORTE QUELLE SURFACE.

CUIDADO: FAVOR DE LEER TODAS LAS INSTRUCCIONES ANTES DE ENSAMBLAR SU PRODUCTO, ESTAS PIEZAS SON PESADAS. PARA PREVENIR HERIDAS PERSONALES Y ASEGURAR QUE SU PRODUCTO NO SEA DAÑADO MIENTRAS ES ENSAMBLADO. SE RECOMIENDA LA ASISTENCIA DE UNA O MÁS PERSONAS.

WARNING: PROTECTIVE GLIDE IS PLACED UNDER EACH LEG OF THE FURNITURE TO RESIST SCRATCHES ON FLOOR SURFACE. SOME FLOOR SURFACES CAN BE EXTRA SENSITIVE TO SCRATCHES AND MARKINGS, IF YOU ARE NOT SURE CONSULT WITH YOUR DEALER. AVERTISSEMENT. LES PIEDS DES MEUBLES SONT MUNIS DE PATINS DESTINÉS À PROTÉGER LE PLANCHER. CERTAINS REVÊTEMENTS DE SOL PEUVENT ÊTRE TRÈS FRAGILES. EN CAS DE DOUTE, CONSULTEZ LE MARCHAND.

LIST OF PARTS AND HARDWARE / LISTE DES PIÈCES ET DU MATÉRIEL/ LISTA DE PIEZAS Y HARDWARE				
NO#/ NOMBRE/ NÚMERO	DESCRIPTION/ DESCRIPTION/ DESCRIPCIÓN			QUANTITY/ QUANTITÉ/ CANTIDAD
A	FLAT WASHER/ RONDELLE PLATE/ ARANDELA PLANA	φ5/16"×3/4"		12 PCS
B	LOCK WASHER/ RONDELLE DE BLOCAGE/ ARANDELA DE BLOQUEO	φ5/16"×1/2"		16 PCS
C	BOLT/ BOULON/ TORNILLO	φ5/16"×2-3/8"L		16 PCS
D	ALLEN WRENCH/ CLÉ ALLEN/ Llave inglesa ALLEN	4mm		1 PC
E	FLAT WASHER/ RONDELLE PLATE/ ARANDELA PLANA	φ5/16"×5/8"		4 PCS
F	WOOD PLUG/ BOUCHON À BOIS/ TAPON DE MADERA	φ20.5mm×13mm		4 PCS
G	SCREW/ VIS/ TORNILLO	#4×1-1/2"		4PCS
H	SCREW/ VIS/ TORNILLO	#4×1"		1PC

LIST OF PARTS AND HARDWARE/ LISTE DES PIÈCES ET DU MATÉRIEL/ LISTA DE PIEZAS Y HARDWARE				
NO#/ NOMBRE/ NÚMERO	DESCRIPTION/ DESCRIPTION/ DESCRIPCIÓN			QUANTITY/ QUANTITÉ/ CANTIDAD
1	PD4398/4399/4400/4805 - 79CB CHAIR BACK/ DOSSIER DE CHAISE/ RESPALDO DE CHAIR BACK			1 PC
2	PD4398/4399/4400/4805-79SF SEAT FRAME/ CADRE DU SIÈGE/ MARCO DEL ASIENTO			1 PC
3	PD4398/4399/4400/4805-79LL LEG(LEFT) / PATTE(GAUCHE)/ PIERNA(IZQUIERDA)			1 PC
4	PD4398/4399/4400/4805-79LR LEG(RIGHT)/ PATTE(DROITE)/ PIERNA(DERECHO)			1 PC
5	PD4398/4399/4400/4805-79LB LEG(BACK)/ PATTE(DOS)/ PIERNA(ESPALDA)			1 PC
6	PD4398/4399/4400/4805-79SS SHORT STRETCHER/ RALLONGE COURTE / ENSANCHADOR CORTO			1 PC
7	PD4398/4399/4400/4805-79FL FRONT LEG/ PATTE AVANT/ PATA DE ENFRENTE			1 PC
8	PD4398/4399/4400/4805-79SR LONG STRETCHER/ RALLONGE LONGUE / ENSANCHADOR LARGO			1 PC

NOTE:
ASSEMBLE UNIT ON A SOFT SURFACE.
ASSEMBLEZ L'UNITÉ SUR UNE SURFACE MOLLE.
ENSAMBLE LA UNIDAD EN UNA SUPERFICIE PLANA Y SUAVE.

DO NOT TIGHTEN BOLTS UNTIL THE UNIT IS COMPLETELY ASSEMBLED.
NE SERREZ PAS LES BOULONS JUSQU'À CE QUE L'UNITÉ SOIT COMPLÈTEMENT ASSEMBLÉE.
NO APRIETE LOS TORNILLOS HASTA QUE LA UNIDAD ESTE COMPLETAMENTE ENSAMBLADA.



WARNING:
Only use the hand tools provided.

ASSEMBLY INSTRUCTIONS INSTRUCTIONS DE MONTAGE INSTRUCCIONES DE MONTAJE

Step/ Étape/ Paso 1

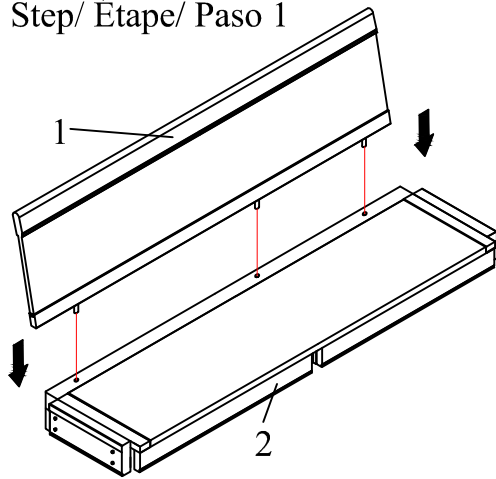

Step/ Étape/ Paso 2

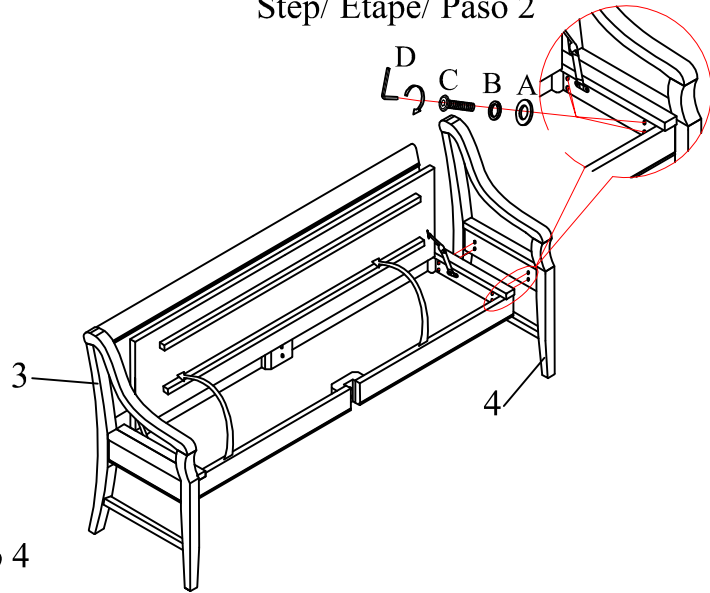

Step/ Étape/ Paso 4

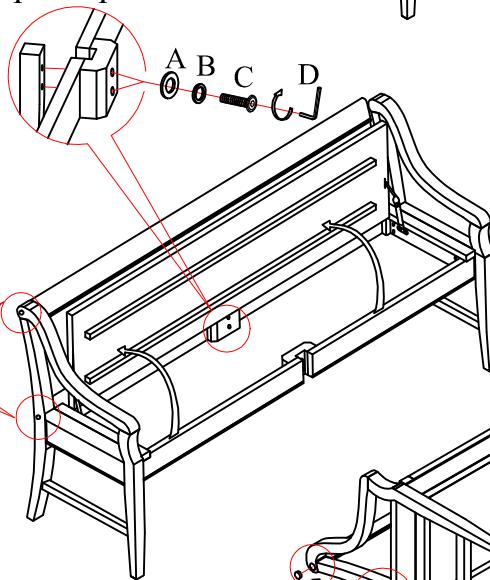

Step/ Étape/ Paso 3

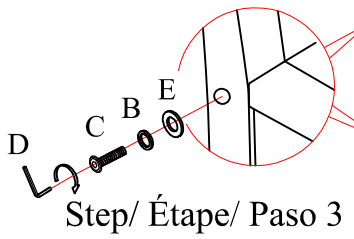

Step/ Étape/ Paso 5

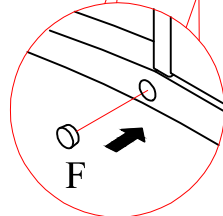

Step/ Étape/ Paso 6



WARNING:
Only use the hand tools provided.

