

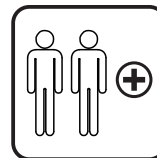

IN230900087V01_GL

84C-471V00

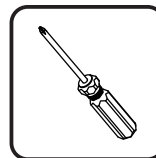
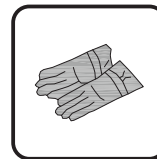
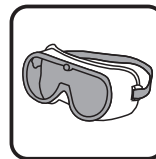
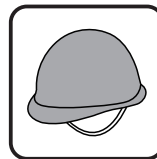
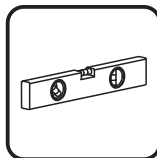
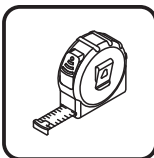
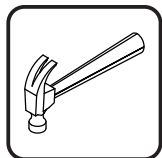
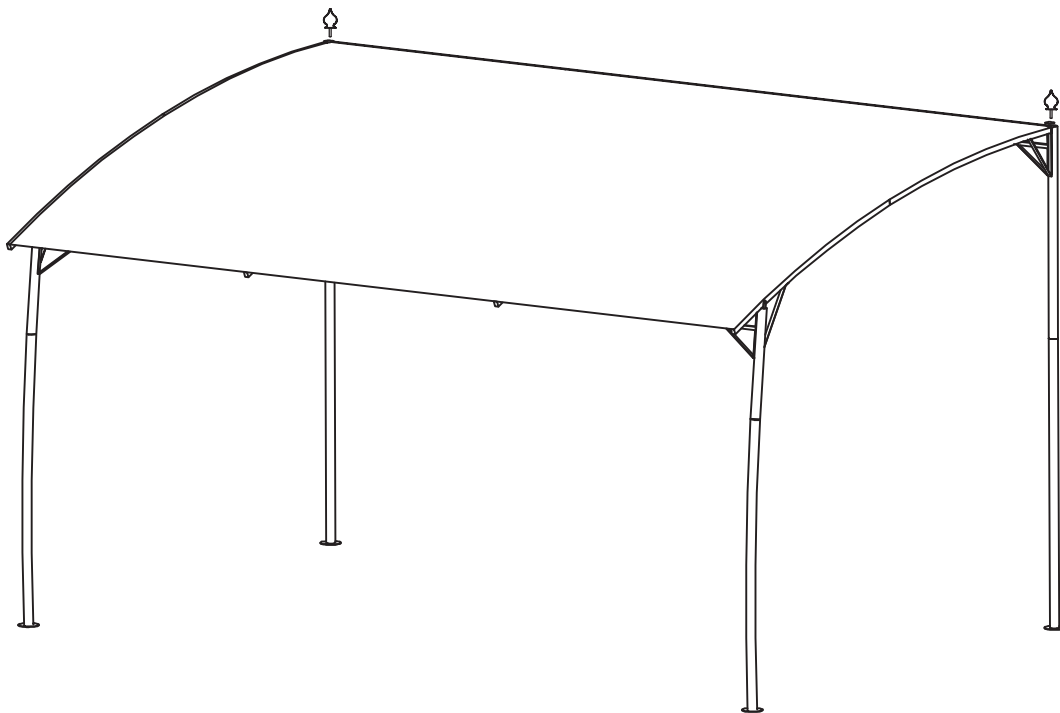

Tools Recommended

EN_IMPORTANT, RETAIN FOR FUTURE REFERENCE: READ CAREFULLY.

FR_IMPORTANT: A LIRE ATTENTIVEMENT ET À CONSERVER POUR CONSULTATION ULTÉRIEURE.

ES_IMPORTANTE, LEA Y GUARDE PARA FUTURAS REFERENCIAS.

PT_IMPORTANTE, RETER PARA REFERÊNCIA FUTURA: LEIA ATENTAMENTE.

DE_WICHTIG! SORGFÄLTIG LESEN UND FÜR SPÄTER NACHSCHLAGEN AUFBEWAHREN.

IT_IMPORTANTE! CONSERVARE IL PRESENTE MANUALE PER FUTURO RIFERIMENTO E LEGGERLO ATTENTAMENTE.

EN

Dear customer,

Thank you for purchasing this product. So that your appliance serves you well, please read all the instructions in this user's manual. If you have any questions, please contact our customer care center, Our contact details are below:

FR

Cher client,

Nous vous remercions d'avoir acheté ce produit. Afin que vous puissiez profiter pleinement de votre appareil, veuillez lire toutes les instructions de ce manuel d'utilisation. Si vous avez la moindre question, veuillez contacter notre centre d'assistance à la clientèle, Nos coordonnées sont les suivantes:

DE

Sehr geehrter Kunde,

Vielen Dank, dass Sie dieses Produkt erworben haben. Damit Ihr Gerät Ihnen gute Dienste leistet, lesen Sie bitte alle Hinweise in diesem Benutzerhandbuch. Wenn Sie Fragen haben, wenden Sie sich bitte an unser Kundendienstzentrum, Unsere Kontaktdaten stehen unten:

ES

Queridos clientes,

Gracias por comprar este producto. Para que su electrodoméstico le sirva mejor, lea todas las instrucciones de este manual del usuario. Si tiene alguna pregunta, comuníquese con nuestro Centro de Atención al Cliente, Nuestros datos de contacto son los siguientes:

PT



Caros clientes,

Obrigado por adquirir este produto. Para que o seu aparelho o sirva melhor, leia todas as instruções deste manual do utilizador. Se tiver alguma dúvida, por favor contacte o nosso Centro de Atendimento ao Cliente, Os nossos dados de contacto são os seguintes:

IT

Caro Cliente,

Grazie per aver acquistato questo prodotto. Per servirti meglio con questo apparecchio ti prego di leggere tutte le istruzioni in presente manuale utente. In caso di dubbio, si prega di contattare il nostro centro assistenza clienti, I nostri dettagli di contatto sono di seguito:

Country	 Phone	 Email
US	001-877-644-9366	customerservice@aosom.com
CA	416-792-6088	customerservice@aosom.ca
UK	0044-800-240-4004	enquiries@mhstar.co.uk
DE	0049-0(40)-88307530	service@aosom.de
FR	0033-1-84166106	aosom@mhfrance.fr
ES	0034-931294512	atencioncliente@aosom.es
PT	0034-931294512	info@aosom.pt
IT	0039-0249471447	clienti@aosom.it

EN

IMPORTANT SAFETY NOTICE

Product is NOT INTENDED for the following:

- A safety barrier to prevent unsupervised access to pools, hot tubs, spas or ponds.
- As load bearing support for a building, structure, heavy objects or swings.
- Used in structures that trap wind, rain or snow that would create extra load on the product.

Accumulated snow must be removed from roof.

DO NOT climb or walk on roof for any reason.

Wear gloves to avoid injury from possible sharp edges of individual elements before assembly.

During installation, follow all safety warnings provided with your tools.

Some structures may require two or more people to install safely.

Check for underground utilities before digging or driving stakes into the ground!

It is important during assembly to closely follow the instructions, complete the assembly on a solid level surface and that you follow the instruction to square up, level and anchor the structure, this will reduce the gap at connections during assembly.

FR

AVIS IMPORTANT DE SÉCURITÉ

Le produit n'est PAS DESTINÉ à ce qui suit :

- Une barrière de sécurité pour empêcher l'accès non surveillé aux piscines, aux spas, aux cuves thermales ou aux étangs.
- Comme support de charge pour un bâtiment, une structure, des objets lourds ou des balançoires.
- Utilisé dans des structures qui retiennent le vent, la pluie ou la neige qui créeraient une charge supplémentaire sur le produit.

La neige accumulée doit être enlevée du toit.

NE PAS grimper ou marcher sur le toit pour quelque raison que ce soit.

Portez des gants pour éviter les blessures causées par d'éventuels bords tranchants des composants avant de procéder à l'assemblage.

Lors de l'installation, respectez tous les avertissements de sécurité fournis avec vos outils.

Certaines structures peuvent nécessiter l'intervention de deux personnes ou plus pour les installer en toute sécurité.

Vérifiez la présence de services publics souterrains avant de creuser ou de planter des piquets dans le sol !

Il est important, pendant tout le processus de montage, de suivre attentivement les instructions, de terminer l'assemblage sur une surface solide et plane et de suivre les instructions d'équerrage, de mise à niveau et d'ancrage de la structure, ce qui permettra de réduire les écarts au niveau des liaisons pendant le montage.

ES

AVISO IMPORTANTE DE SEGURIDAD

Manténgase alejado de las líneas eléctricas aéreas.

No coloque ni instale su tienda de campaña debajo de los árboles debido a posibles rayos o hundimiento de las ramas de los árboles en condiciones climáticas adversas. Para obtener las mejores condiciones en caso de viento fuerte, coloque el extremo estrecho de la tienda en la dirección del viento.

No dejes caer la tienda de campaña.

No haga rebotar ni golpee la bolsa de la tienda para sacarla, estas acciones podrían dañar el marco.

ESTE PRODUCTO REQUIERE UN MÍNIMO DE DOS PERSONAS PARA SU MONTAJE

Bajo ninguna circunstancia se debe utilizar este producto para cubrir automóviles, vehículos marinos o artículos similares.

PRECAUCIÓN: Vigile no pellizcarse los dedos durante el montaje y desmontaje de la tienda al unir las piezas del marco.

AVISO DE SEGURANÇA IMPORTANTE

O produto NÃO é DESTINADO ao seguinte:

- Uma barreira de segurança para impedir o acesso sem supervisão a piscinas, banheiras, spas ou lagos.
- Como suporte de carga para um edifício, estrutura, objectos pesados ou baloiços.
- Usado em estruturas que apanham vento, chuva ou neve que criariam carga extra sobre o produto.

A neve acumulada deve ser removida do telhado. NÃO subir ou caminhar no telhado por qualquer razão.

Usar luvas para evitar ferimentos causados por possíveis arestas vivas de elementos individuais antes da montagem.

Durante a instalação, siga todos os avisos de segurança fornecidos com as suas ferramentas. Algumas estruturas podem exigir a instalação segura de duas ou mais pessoas. Verifique a existência de utilidades subterrâneas antes de escavar ou de conduzir estacas no solo!

É importante durante a montagem seguir de perto as instruções, completar a montagem numa superfície sólida e nivelar e ancorar a estrutura, o que reduzirá a folga nas ligações durante a montagem.

WICHTIGER SICHERHEITSHINWEIS

Das Produkt ist NICHT für einen der folgenden Anwendungen bestimmt:

- Als Sicherheitsbarriere, die den unbeaufsichtigten Zugang zu Pools, Whirlpools, Spas oder Teichen verhindert.
- Als tragende Stütze für ein Gebäude, eine Struktur, schwere Gegenstände oder Schaukeln.
- Als Bestandteil einer Struktur verwendet werden, welche Wind, Regen oder Schnee abfangen, die eine zusätzliche Belastung für das Produkt darstellen würden.

Angesammelter Schnee muss vom Dach entfernt werden.

Aus keinem Grund darf das Dach bestiegen oder betreten werden.

Bitte tragen Sie stets geeignete Arbeitshandschuhe, um Verletzungen durch mögliche scharfe Kanten einzelner Elemente während der Montage zu vermeiden.

Befolgen Sie während des Installationsprozesses bitte sorgfältig alle Sicherheitswarnungen, die mit Ihren Werkzeugen geliefert werden.

Einige Strukturen können zwei oder mehr Personen erfordern, um sicher installiert zu werden.

Prüfen Sie vor dem Graben oder Eintreiben von Pfählen in den Boden, ob Erdkabel vorhanden sind!

Es ist wichtig, während der Montage die Anweisungen genau zu befolgen, Ihr Produkt auf einem festen und ebenen Untergrund aufzustellen und die Anweisung zum Aufrichten, Nivellieren und Verankern der Struktur zu befolgen, da dadurch der Spalt an den Verbindungen während der Montage verringert wird.

IMPORTANTI PRECAUZIONI DI SICUREZZA

Il prodotto NON è PROGETTATO per quanto segue:

- Una barriera di sicurezza per impedire l'accesso senza supervisione a piscine, vasche idromassaggio, spa o stagni.
- Supporto portante di edifici, strutture, oggetti pesanti o altalene.
- Parte di strutture che accumulano vento, pioggia o neve, in quanto creerebbero un carico extra sul prodotto.

La neve accumulata deve essere rimossa dal tetto.

NON salire o camminare sul tetto per nessun motivo.













Indossare guanti per evitare lesioni derivanti da spigoli vivi dei singoli componenti prima del montaggio.

Durante l'installazione, seguire tutte le precauzioni di sicurezza fornite con gli strumenti.

Alcune strutture possono richiedere due o più persone per essere installate in sicurezza.

Controlla le utenze sotterranee prima di scavare o piantare pali nel terreno!

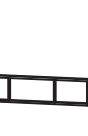
È importante che durante il montaggio vengano seguite attentamente le istruzioni, inoltre completare il montaggio su una superficie piana e solida e seguire le istruzioni per allineare, livellare e ancorare la struttura, in quanto questo ridurrà lo spazio necessario durante il montaggio.

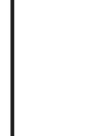
Ax2 	A1x2 	Bx2 	Cx2 	Dx2 	Ex1 	Fx1 
Gx2 	Hx2 	Ix15 	Jx1 	Kx2 	Lx2 	
Nx8 	Ox1 	Px34 M6	Qx6 M6x $\frac{15}{0.6}$	Rx16 M6x $\frac{28}{1.1}$	Sx2 M6x $\frac{35}{1.3}$	
Tx16 M6x $\frac{60}{2.3}$	Ux1 	Vx1 	Wx4 	mm inch x2		

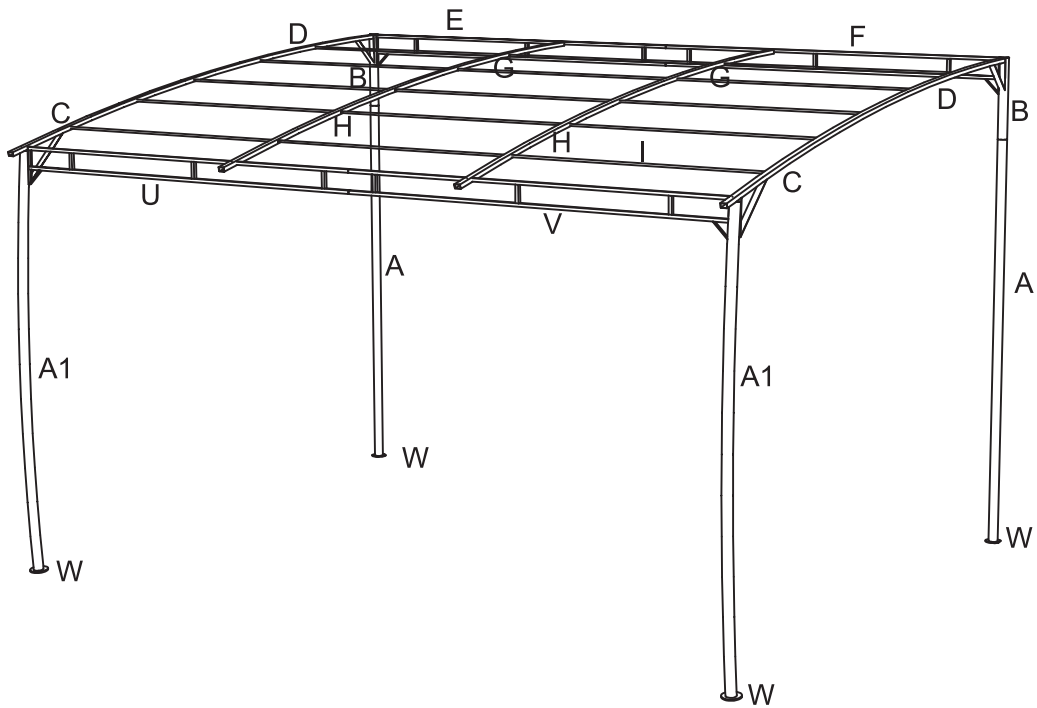

P	x12
Q	x2
R	x4
T	x8

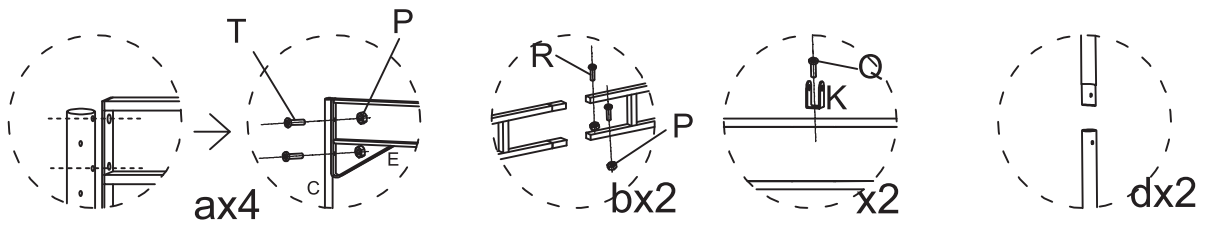
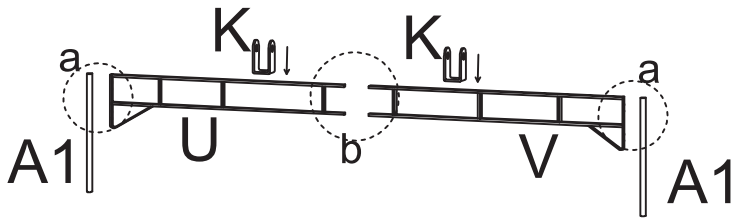
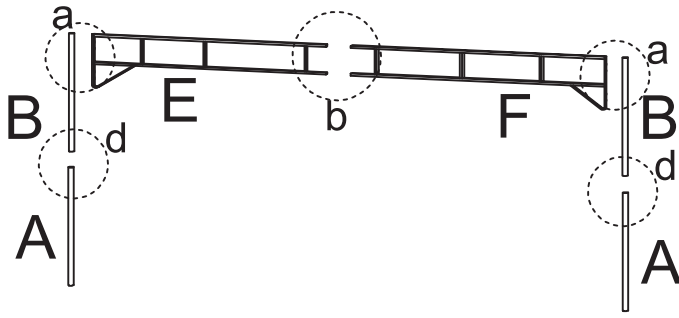

P	x22
Q	x4
S	x2
R	x12
T	x8

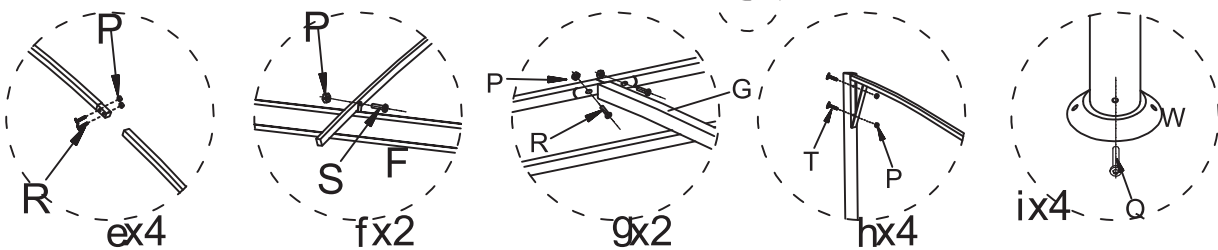
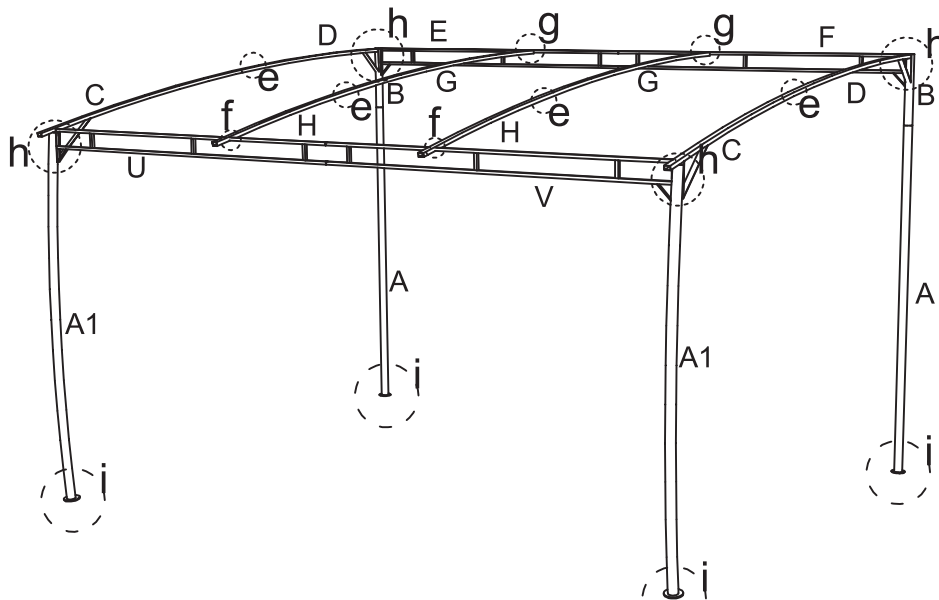

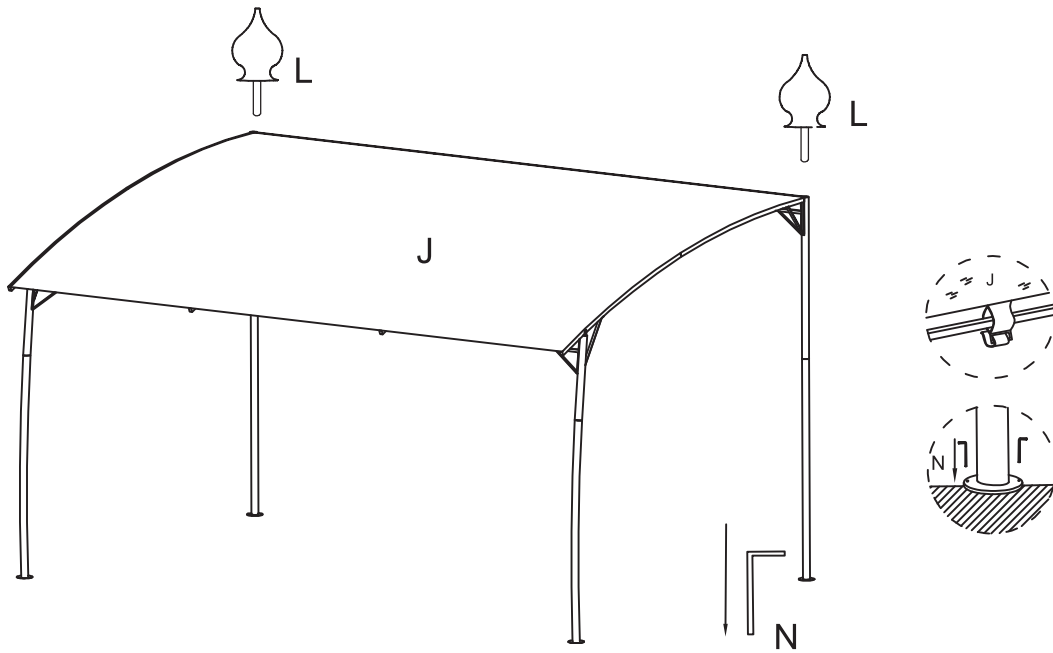
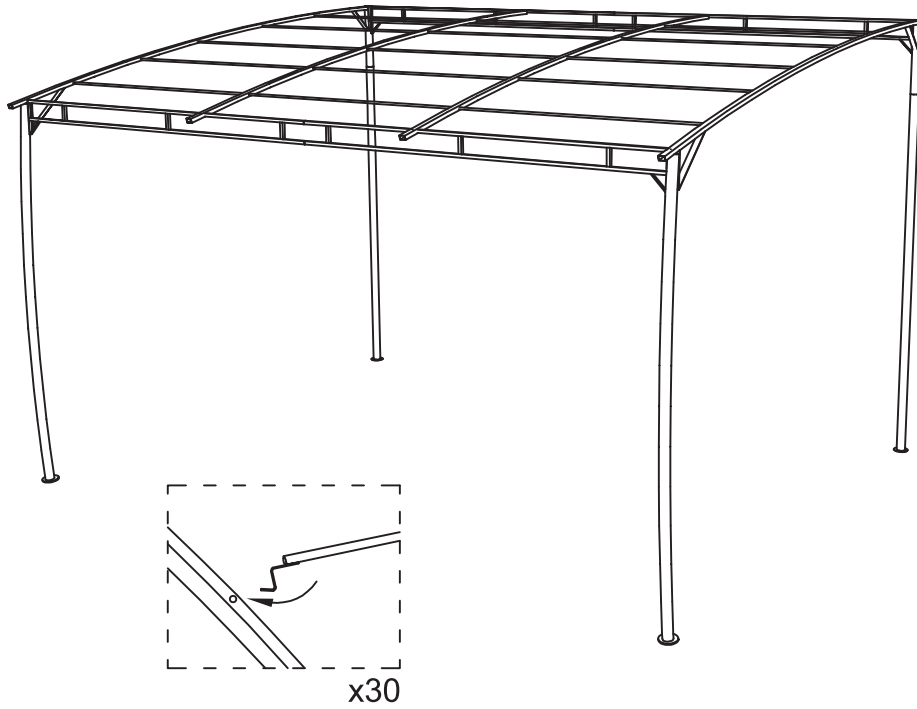

US

Imported by Aosom LLC
 27150 SW Kinsman Rd Wilsonville, OR 97070 USA
 MADE IN CHINA

CA

Imported by Aosom Canada Inc.
 7270 Woodbine Avenue, Unit 307, Markham, Ontario Canada
 L3R 4B9
 MADE IN CHINA

Importé par Aosom Canada Inc.
 7270 Woodbine Avenue, unité 307, Markham, Ontario Canada
 L3R 4B9
 Fabriqué en Chine

UK

IMPORTER ADDRESS:
 MH STAR UK LTD
 Unit 27, Perivale Park,
 Horsenden lane South
 Perivale, UB6 7RH
 MADE IN CHINA

FR

ADRESSE D'IMPORTATION:
 MH FRANCE
 2 Rue Maurice Hartmann
 92130 Issy Les Moulineaux
 France
 FABRIQUÉ EN CHINE



Adresses sur quefairedemesdechets.fr

ES

IMPORTADOR:
 SPANISH AOSOM, S.L.
 C/ROC GROS, Nº15.08550, ELS HOSTALETS DE BALENYÀ, SPAIN.
 B66295775
 WWW.AOSOM.ES
 ATENCIONCLIENTE@AOSOM.ES
 TEL: 931294512
 HECHO EN CHINA

PT

SPANISH AOSOM, S.L
 C.ROC GROS N.15, 08550. ELS HOSTALETS DE BALENYÀ
 TEL: 931294512 (SEG-SEX DAS 7:30H ÀS 16:30H)
 INFO@AOSOM.PT
 WWW.AOSOM.PT

DE

ADRESSE DES IMPORTEURE:
 MH Handel GmbH
 Wendenstraße 309
 D-20537 Hamburg
 Germany
 IN CHINA HERGESTELLT

IT

IMPORTATO DA:
 AOSOM Italy srl
 Centro Direzionale Milanofiori
 Strada 1 Palazzo F1
 20057 Assago (MI)
 P.I.: 08567220960
 FATTO IN CINA