

ASSEMBLY INSTRUCTION

INSTRUCTIONS DE MONTAGE

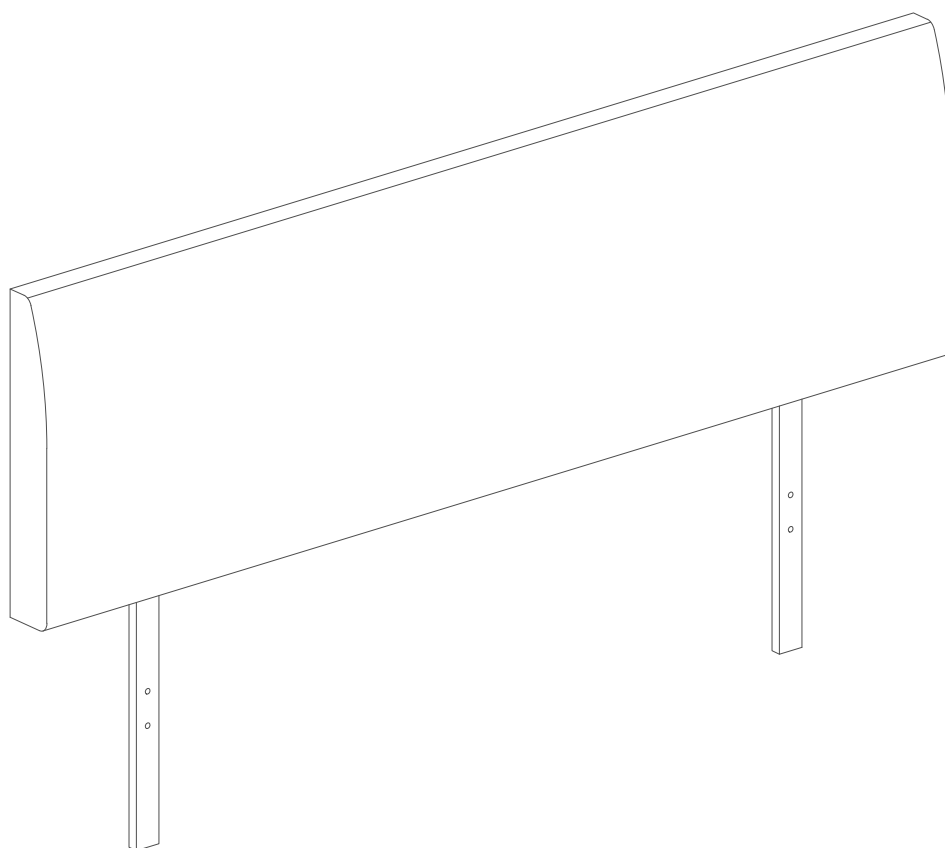

ASSEMBLY INSTRUCTION

INSTRUCTIONS DE MONTAGE

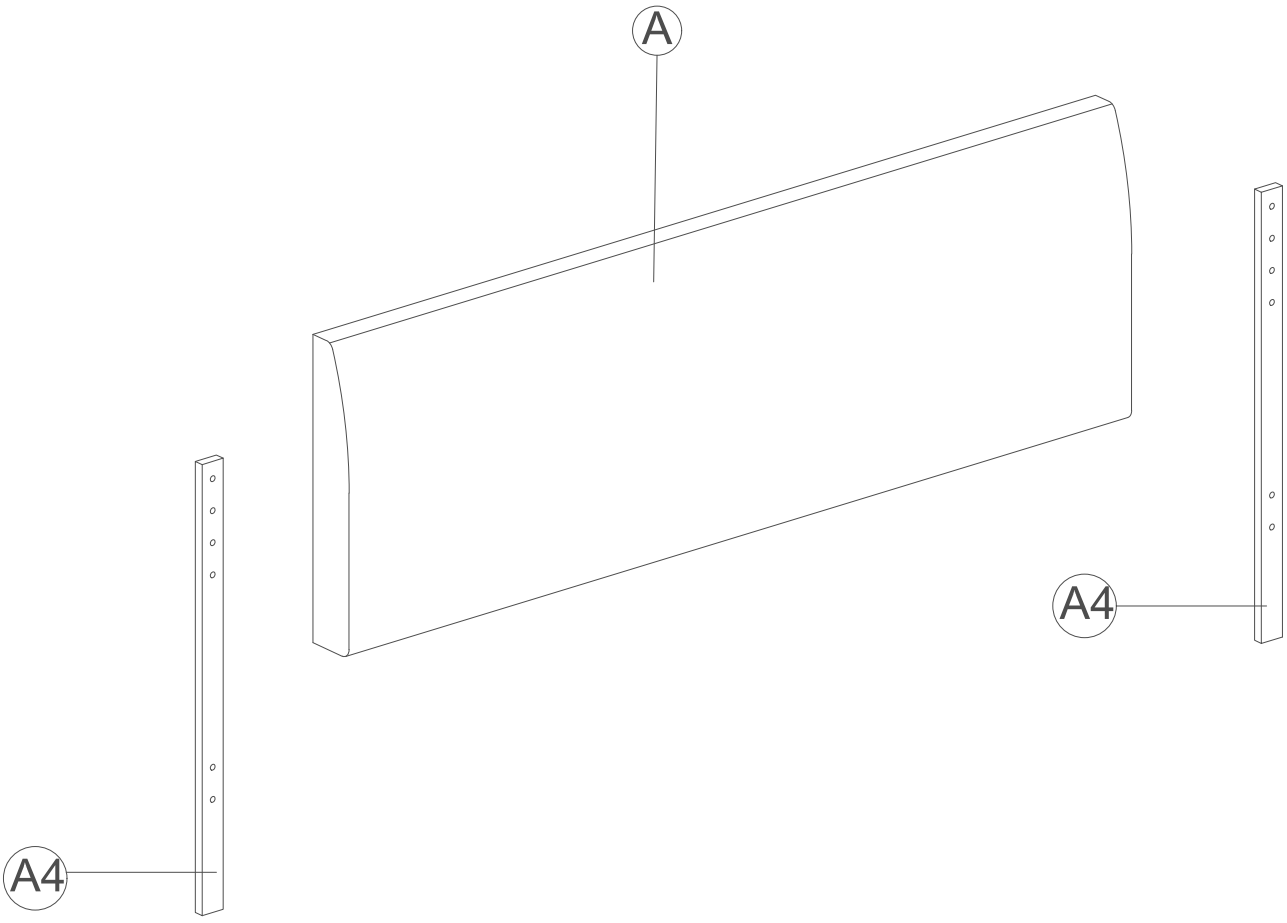

Part List & Hardware List

Liste des pièces et liste du matériel

A

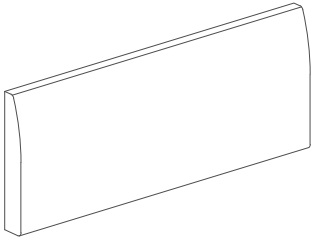

Headboard-1pc

Tête de lit

A1



Wood leg-2pcs

Jambe

Hardware List

Liste du matériel

1

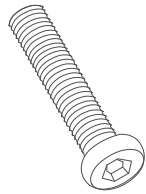

Bolts M8x35 mm-8pcs

Boulon

2



Allen key M5x70x35mm-1pc

Clé allen

STEP 1: The headboard can be adjusted up and down by fixing the position with bolts NO.1 bolts

Étape 1: La tête de lit peut être ajustée vers le haut et vers le bas en fixant la position à l'aide de boulons NO.1boulon

1

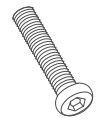

4pcs

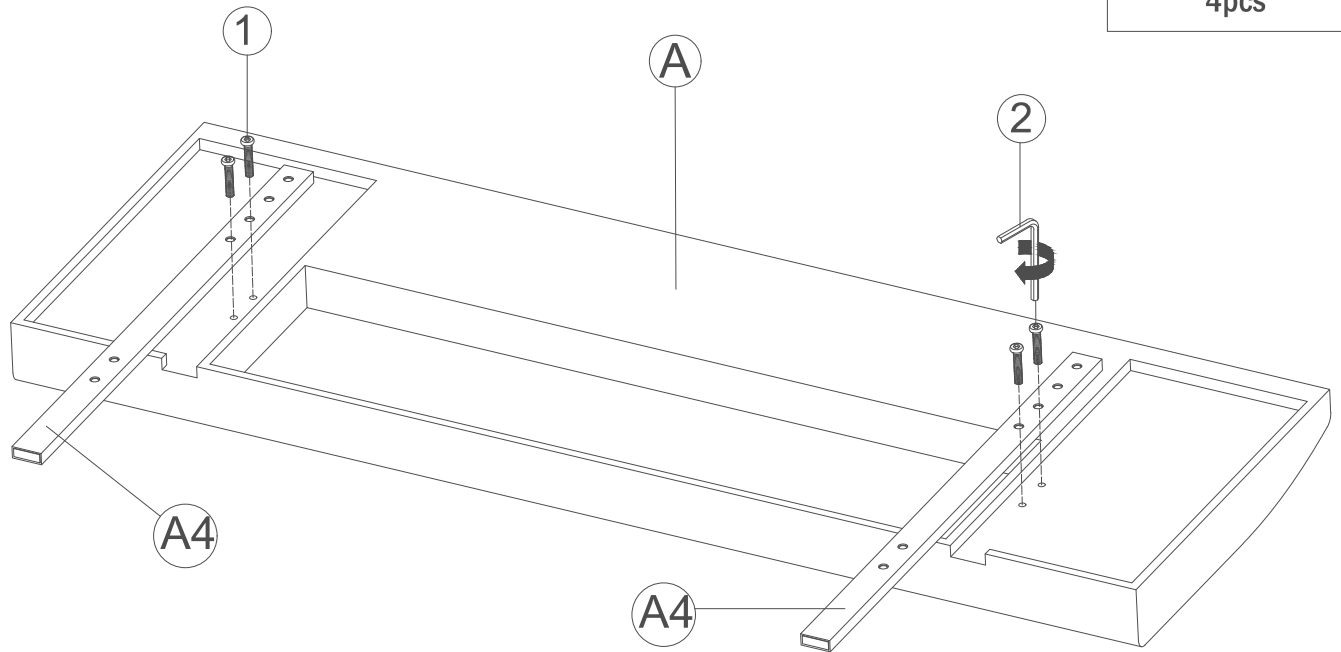

STEP 2:

Étape 2:

Fits a 12" mattress

Fits a 10" mattress

Fits a 8" mattress

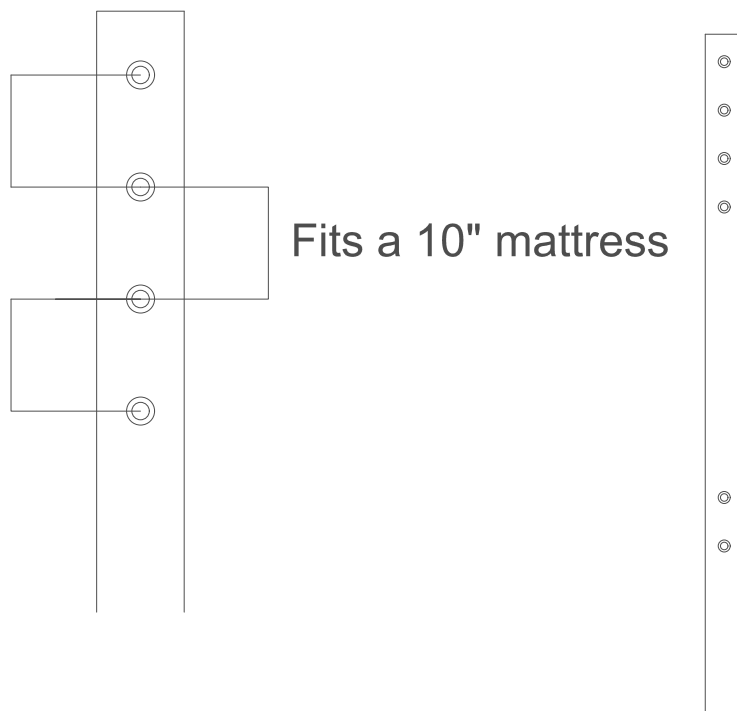

A4

5/6

STEP 3:

Étape 3:

1

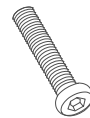

4pcs

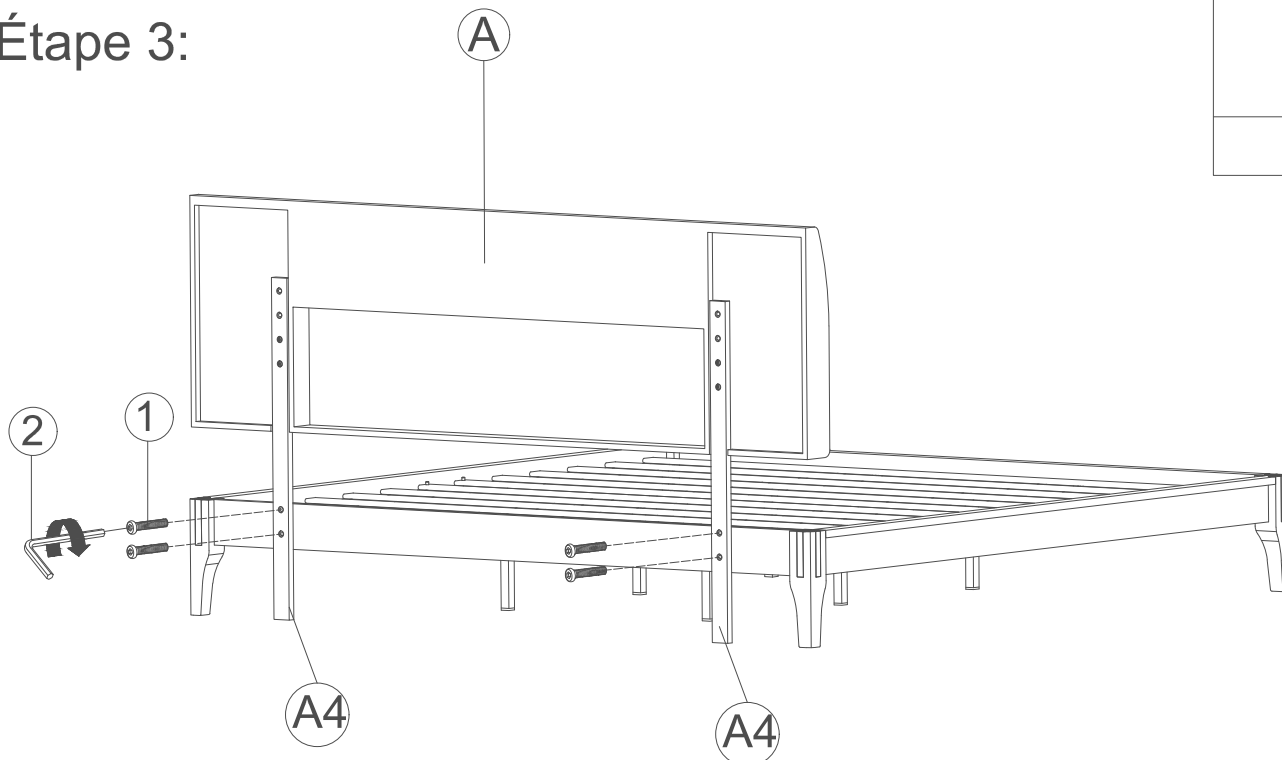

STEP 4:

Étape 4:

