



















ASSEMBLY INSTRUCTION

Before you begin, please follow assembly instruction carefully, then follow step by step.

Read instruction carefully. See furniture Parts List and Hardware List for guidance. Be sure you have all parts before you start assembling. Place and assemble furniture on a clean flat soft surface, such as carpet, rug or carton to prevent being scratched.

Reminder :

Please ensure that all surface and edges with colours / laminations are facing forward / outward.

HARDWARE LIST			QTY
A2		Screw m3.5 x 14mm	74
A4		Screw m3.5 x 20mm	4
A7		Screw m4 x 30mm	4
A17		Crosshead Screw 6.3 x 40mm	14
A18		Crosshead Screw 6.3 x 50mm	4
C5		Square Lock Set	1 Set
D4		Wood Dowel 6 x 25mm	8
E5		Soft Closing Hinge 5/8	6
H6		Handle 128mm	2
L2		Plastic Leg L Shape	4
N1		Allen Key	1
N3		Nail	35 (+-3)
P		Hanging Steel Pipe 18mm x 727mm	1
P1		Hanger 21	1
Q4		Plastic Shelf Support with Steel Pin	12
R1		L Bracket	2
S1		Door Catches	1
S2		Door Stopper	1
Y		Crosshead Cover	14

Each pack have contain different type hardware and size of screw for easy assemble. Please refer to page 2, check a screw size.

CAUTION

MATERIAL USE LAMINATED PARTICLE BOARD, TO CLEAN USE SOFT, DRY CLOTH. DO NOT USE DETERGENT OR CHEMICAL. AVOID CONTACT WITH WATER AND DIRECT SUNLIGHT. TO BE ASSEMBLED ON A SOFT, DRY, CLEAN SMOOTH SURFACE.



USE OF POWER TOOLS TO ASSEMBLE THIS PRODUCT WILL INVALIDATE ANY CLAIM AND MAY DAMAGE THIS PRODUCT MAKING IT UNSAFE.

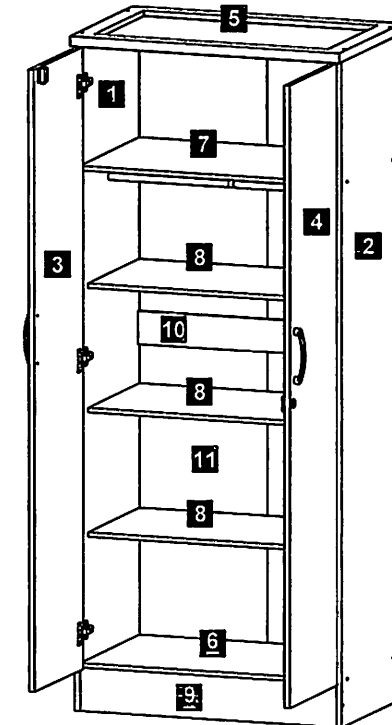
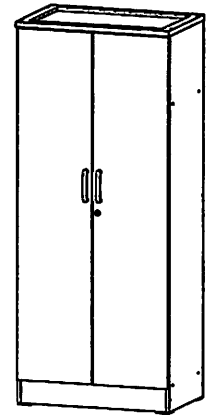

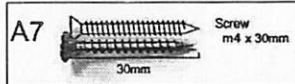
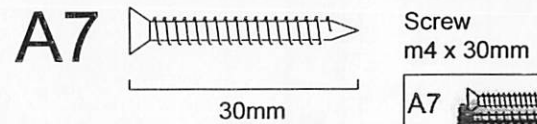
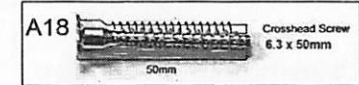
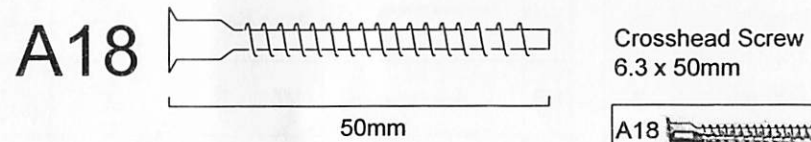
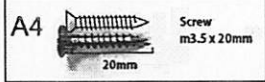
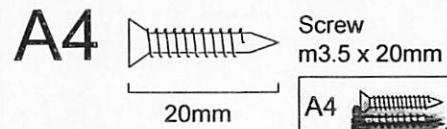
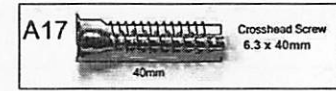
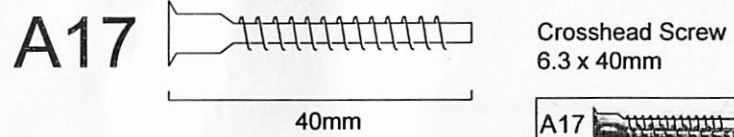
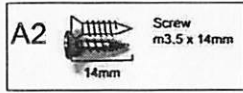
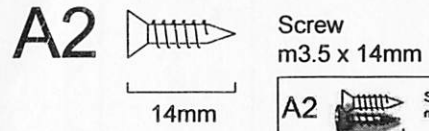

STEP 1 First, assemble each hardware with the different size screw at both door panel no. 3 & 4.

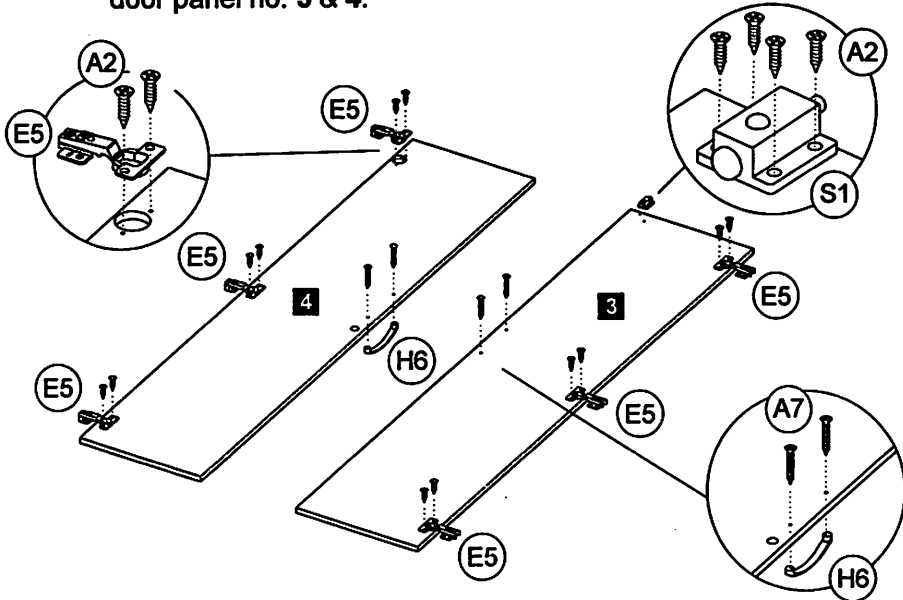

STEP 2 Use Screw (A2) to assemble the Hanger (P1) at marking hole panel no. 7. Insert the Wood Dowel (D4) at both side of panel no. 9.

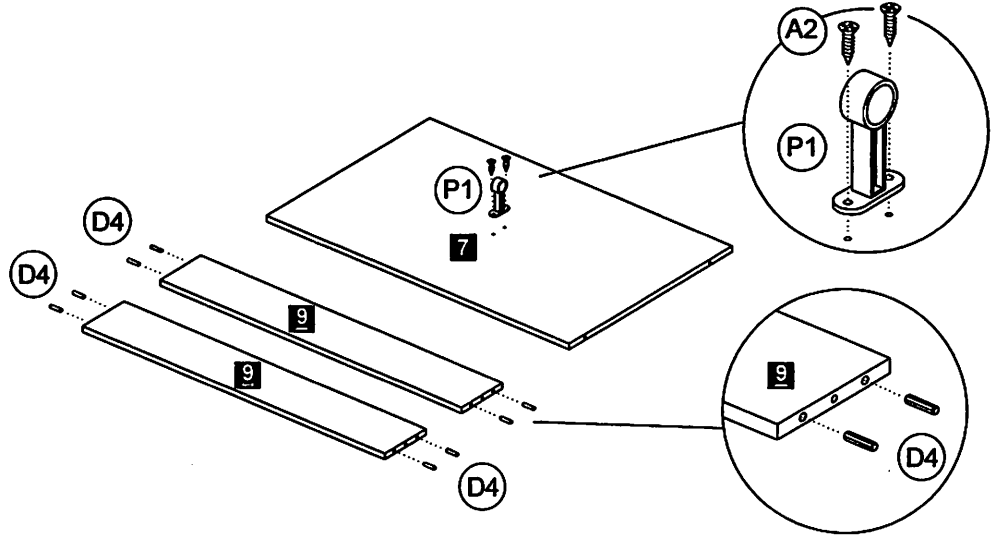

STEP 3 Use Allen Key (N1) to tighten the Crosshead Screw (A17) & button the screw head with Crosshead Cover (Y). Insert the Hanging Steel Pipe (P) through the pipe holder until large marking hole at panel no. 2.

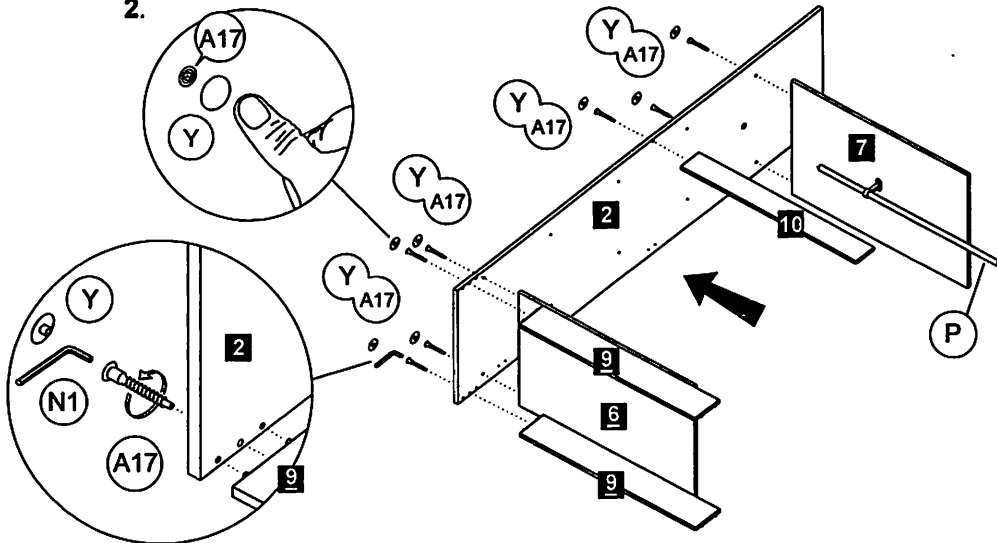

STEP 4 Use Allen Key (N1) to tighten the Crosshead Screw (A17) & button the screw head with Crosshead Cover (Y).

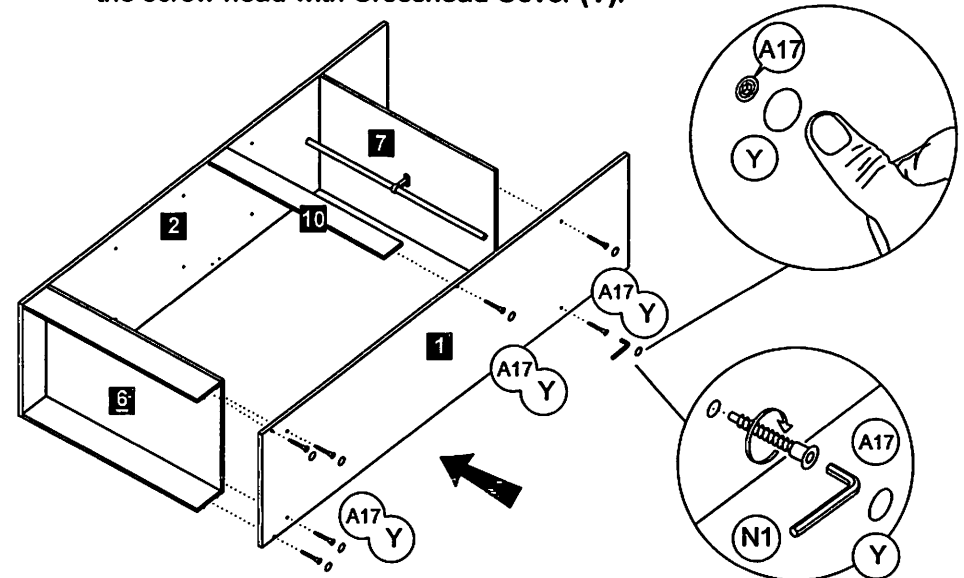

STEP 5 Attach the panel no. 5 in right position. Use Allen Key (N1) to tighten the Crosshead Screw (A18). Screw the L Bracket (R1) at between panel no. 6 & 9.

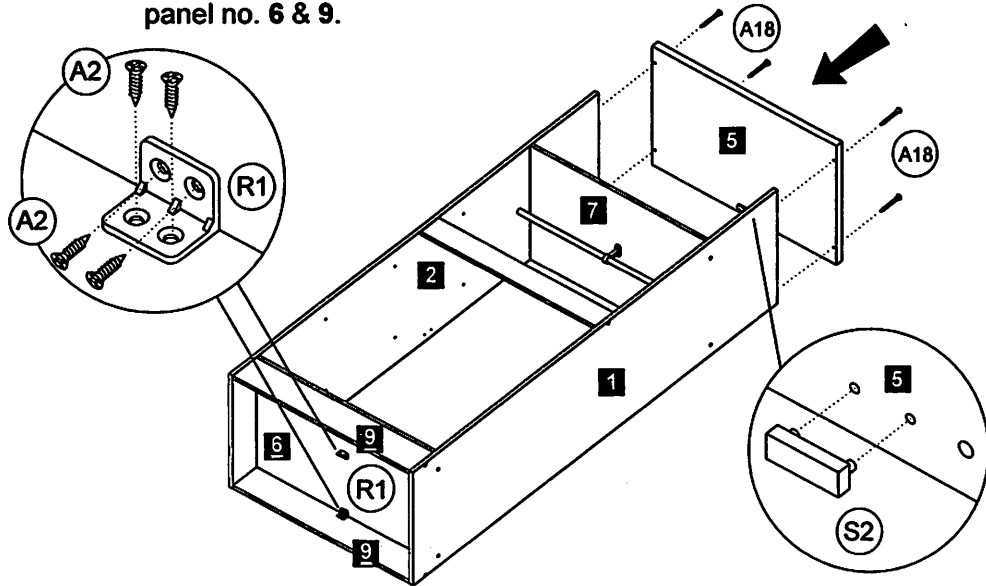

STEP 6 Use Screw (A2) to assemble the Plastic Leg L Shape (L2) at between panel no. 9 & side panels. Assemble the back panel no. 11 with secure by Nail (N3). Panel no. 6 & 10 secure by Screw (A2).

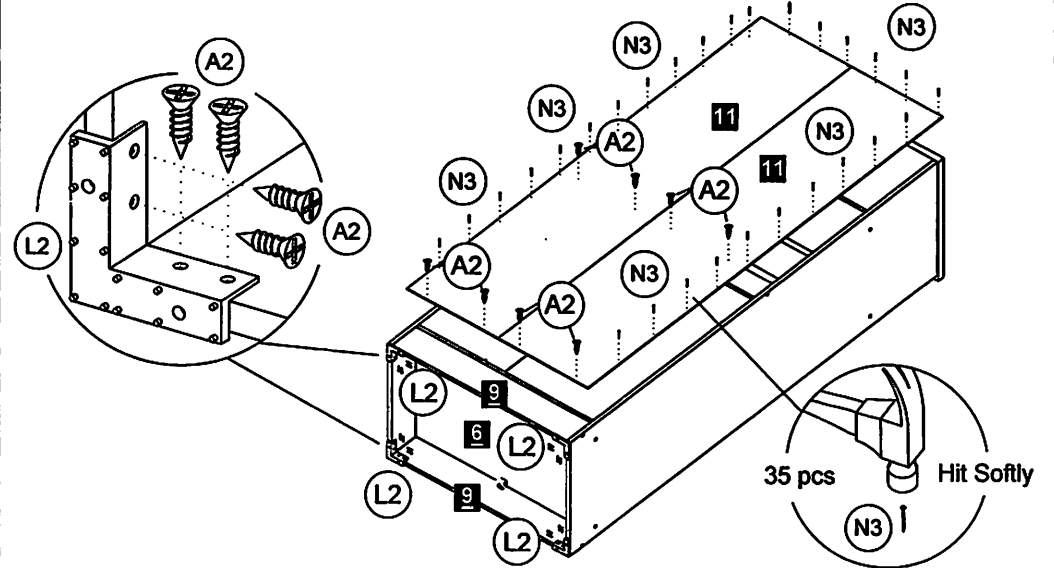

STEP 7 Insert the Plastic Shelf Support With Steel Pin (Q4) at panel 1 & 2. Use Screw (A4) to assemble Square Lock Set (C5) at panel no. 4. Attach the Door Hinges (E5) at panels no. 3 & 4 to side panels then adjust the hinges screw to ensure the parallel of door gaps.

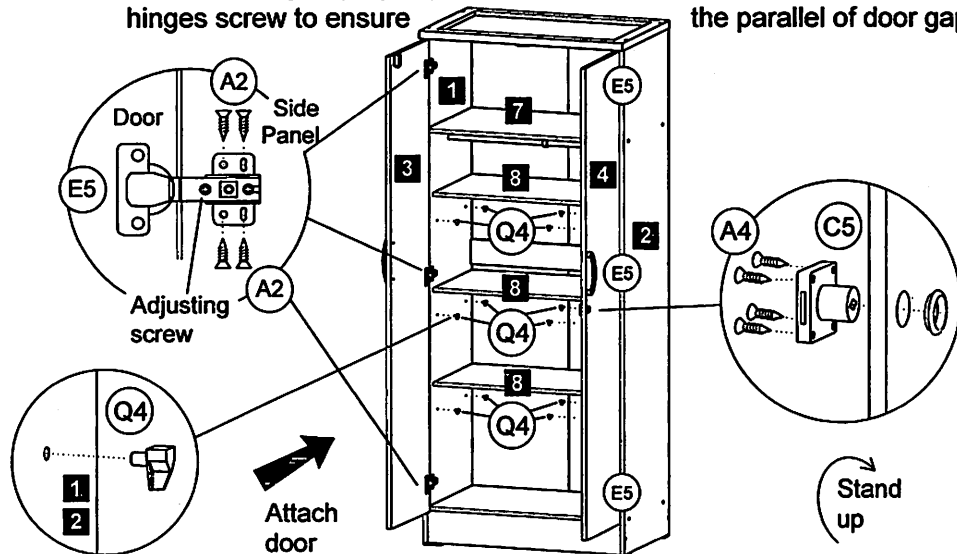

COMPLETE

