

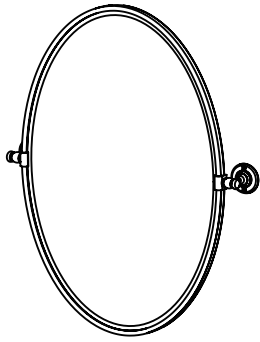

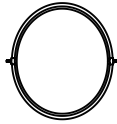

# MOUNTING INSTRUCTIONS

## Contents:

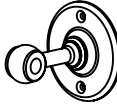

 Mirror X1	 Bracket X2	 Ball Finial X2	 Screw X4	 Anchor X4	 position map X1
---	--	--	--	---	---

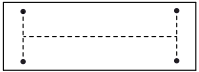

**Missing Hardware:** The parts are been carefully packed within a red bag and inserted in the styrofoam. Please check again in case you do not find the parts. If your order indeed arrives missing hardware, please do not worry, and feel free to reach out to us for help, we will ship you the replacement ASAP.

## Questions, problems, missing parts?

The hardware included with this item is meant for dry wall mounting only. If other wall types, please consult your local hardware store for assistance

1

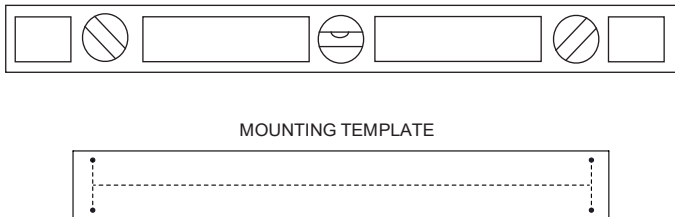

Paste the **position map** horizontally on the position to be installed and mark it with a pencil.

2



Drill four 1/8" pilot holes in wall for each **Plate**  
Screw the plastic **Anchors** into the holes until flush.

3

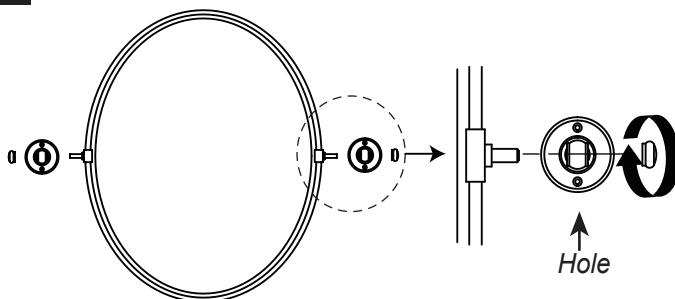

Attach **Brackets** to **Mirror** with **Ball Finials**, with the small holes in the **Brackets** facing down.

4

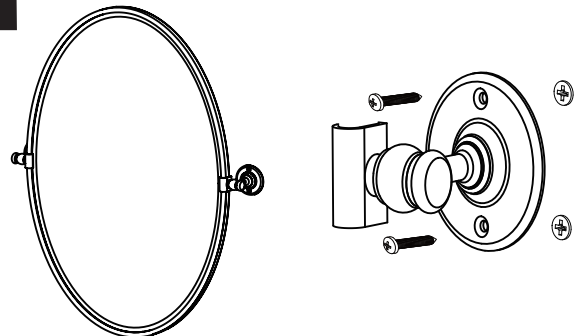

Secure the **Plates** onto the anchors with the **Screws**.

## Cleaning

Avoid using commercial or abrasive cleaners. Using only a soft damp cloth will preserve the finish.