











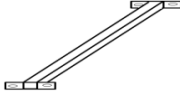



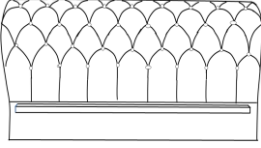

# ASSEMBLY INSTRUCTIONS

COMPONENTS LIST			
1. Pillow Case X2 	2. Vacuum Pillow Core X2 	3. Seat Support Rods X2 	4. Screws M8*80 *X4 
5. Screws M6*30 X8 	6. Sofa leg X4 	7. Non-slip Mat X4 	8. Gaskets X4 
9. Hex Wrench M8 X1 	10. Hex Wrench X1 		
A. Armrest X2 	B. Backrest X1 	C. Front seat Panel X1 	D. Bottom Plate X2 
E. Vacuum Compressed Seat Cushion X3 	F. Seat Cushion Cover X3 	G. Seat Frame X1 	

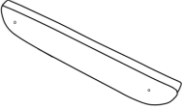
## PRODUCT CHART

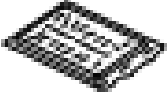

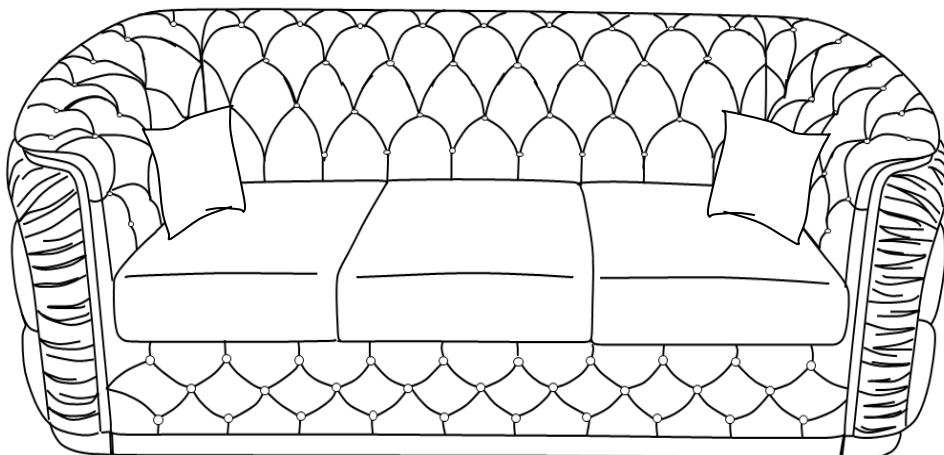
**STEP 1:** Inside the bottom of the Sofa A(Armrest), will find parts E.  
 And inside the bottom of the Sofa B(Backrest), will find parts C, D,  
 and G etc

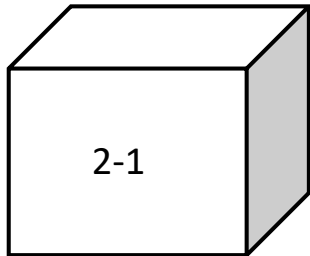

A X2

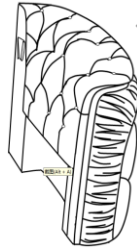

E X2

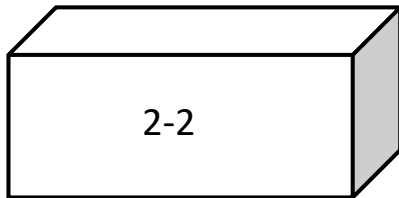
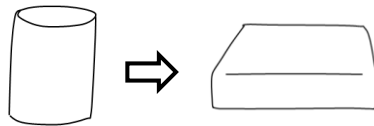

B X1

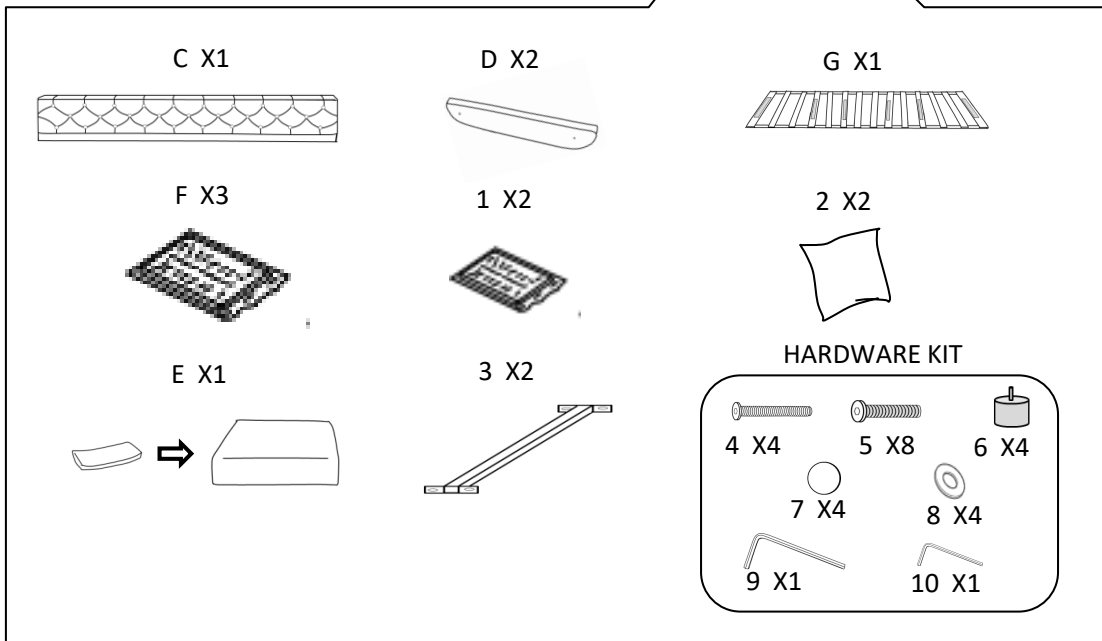
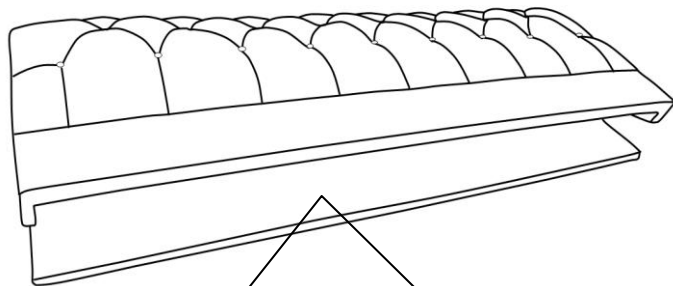

**STEP 2:** For the assembly of the sofa's armrest bottom plate and legs, secure the sofa legs(6) into the designated holes at the bottom of the sofa, and use the tool 9, screws, and gaskets, with the (4/8) components, to fix the bottom plate(D) to the sofa armrest

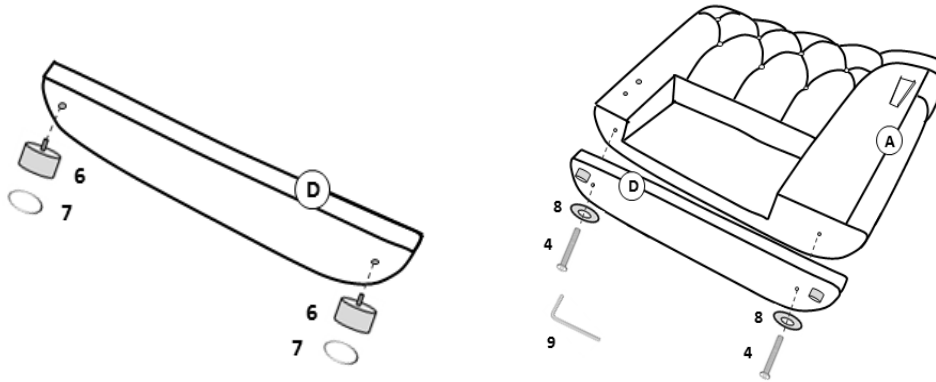

**STEP 3:** Insert the sofa backrest(B) into the armrest(A). Please note: The connecting metal between A/B is buckled from top to bottom. Installing the front panel requires loosening the screws on the armrest, and then tighten the screws after installation

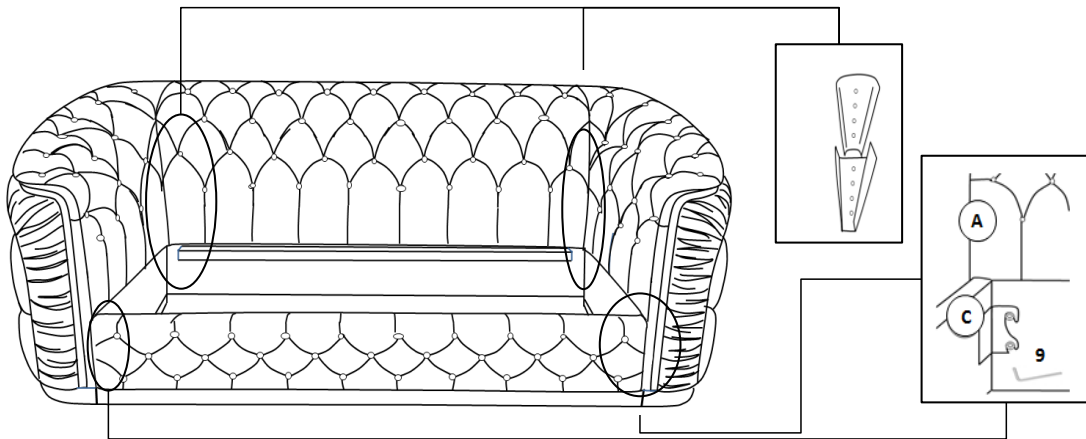

**STEP 4:** Install the seat support rods(3) on the front seat panel(C), use the tool 10, secure them with components 5.

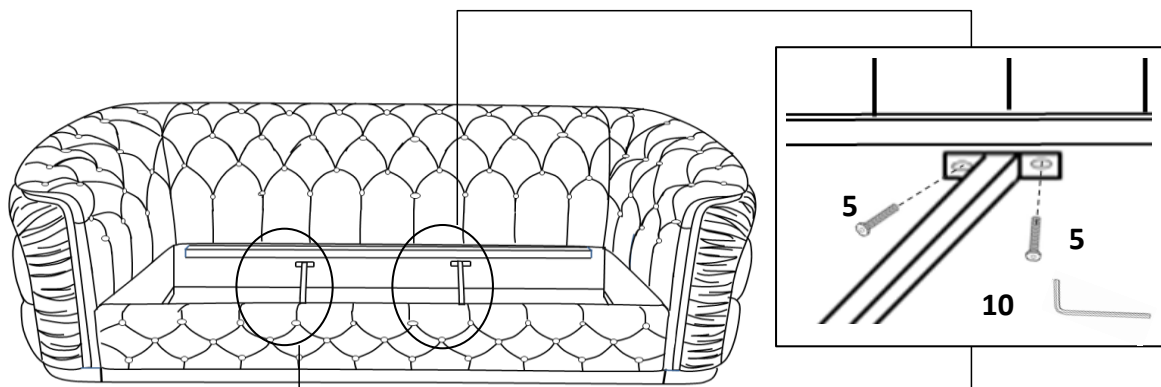

Spread the wooden seat frame G and put it to the sofa.

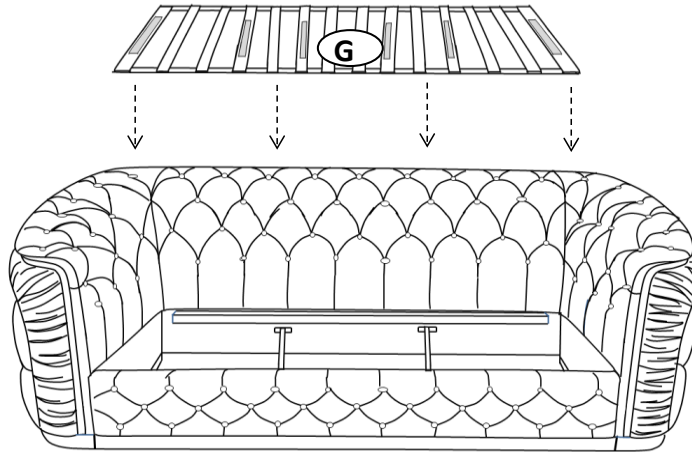

**STEP 5:** Cut the vacuum-compressed sponge cores of sofa seat E, and sofa pillow 2, and then put on the corresponding covers (F and 1) you will finish the assemble of E and 2.

Please note: the shape of the sponge cushion is differentiated between the top and bottom, front and back, the front and top of the cushion is more full and curved, please pay attention to the distinction!

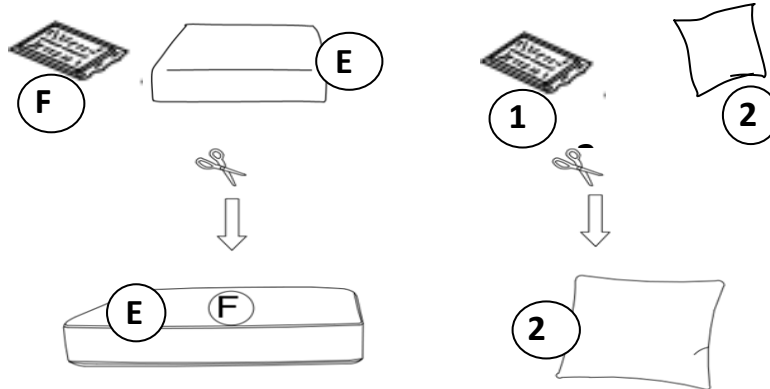

Put E and 2 to the sofa. Congratulation, you finish the job.

