

SOOHOW

Assembly Manual Round Chair CS003

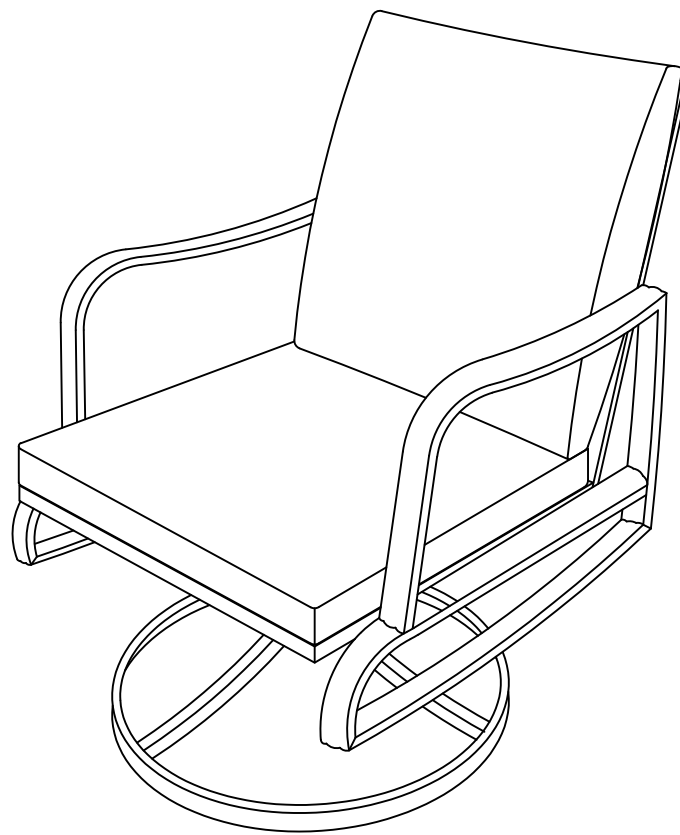





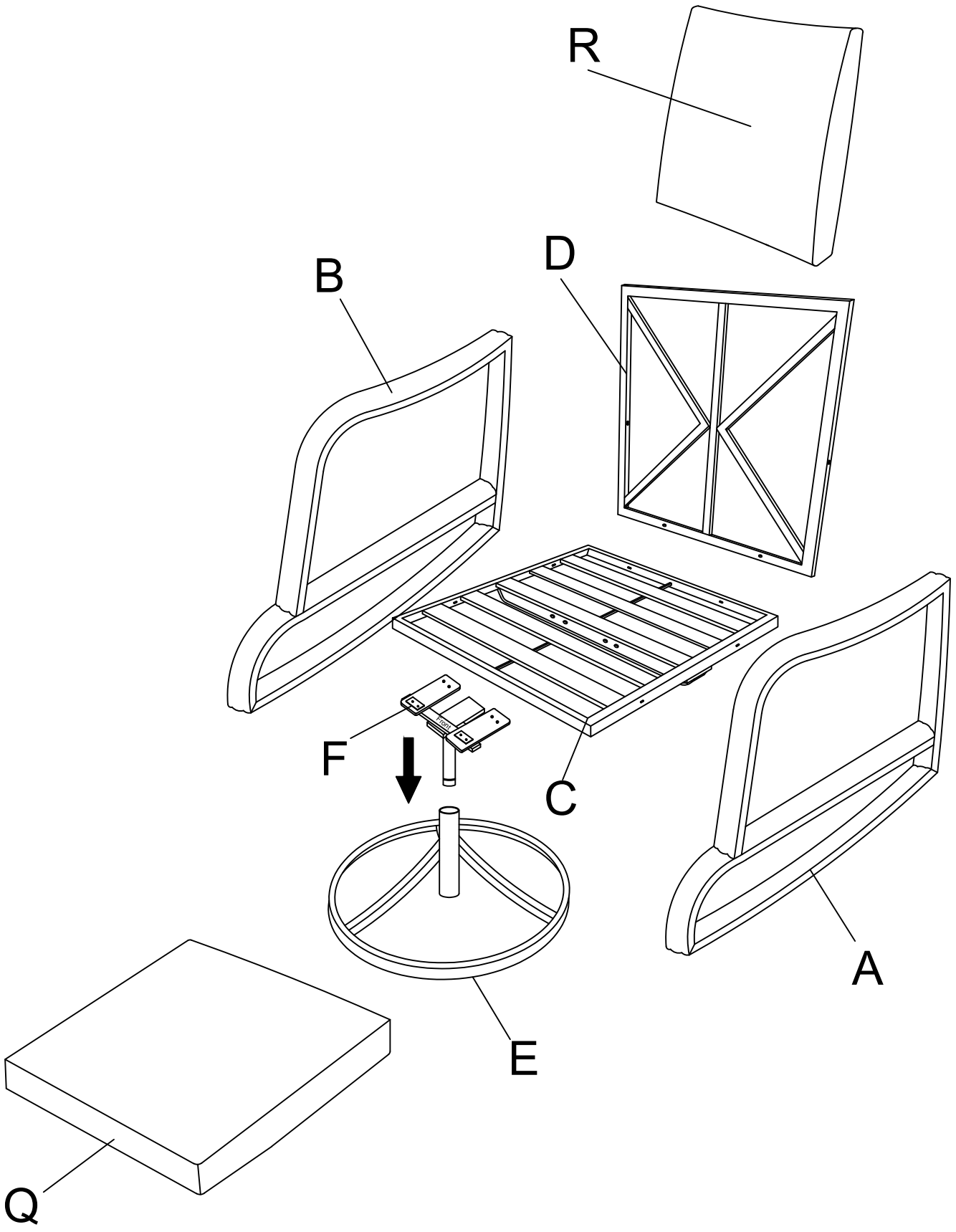

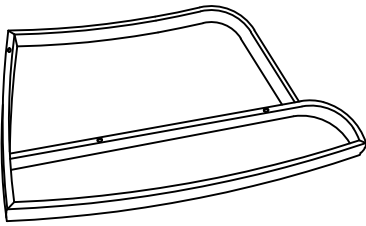
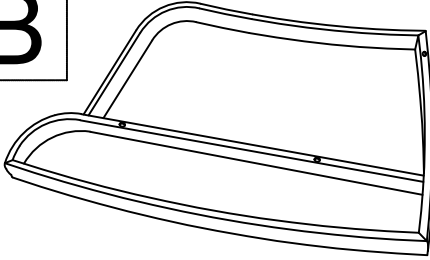
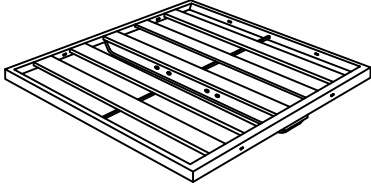
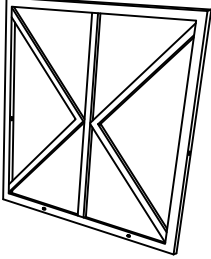
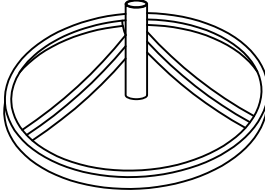
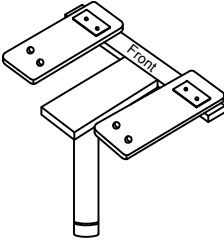

Please read this manual carefully before any operation and keep it properly for future use.

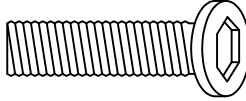
If any problems on our product, please feel free to contact us at ecservice@isunon.com.

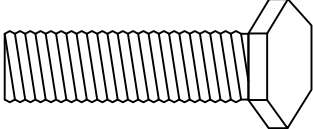

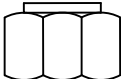
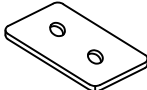
Components List

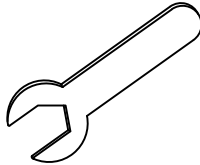
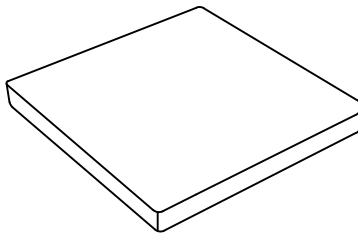
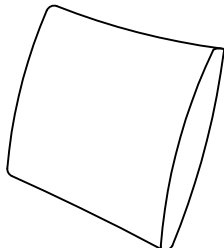
A  Left Armrest 2PCS	B  Right Armrest 2PCS	C  Seat 2PCS
D  Back 2PCS	E  Base 2PCS	F  Rotating plate 2PCS
G  Bolt M6X30 14PCS	H  Bolt M6X40 5PCS	I  Washer M6 19PCS
J  Bolt M8X45 9PCS	K  Washer M8 9PCS	L  Spring Washer M8 9PCS
M  Nut M8 9PCS	N  Small iron piece 50*25*3 5PCS	O  Allen wrench M6 1PC
P  wrench M8 2PCS	Q  Seat Cushion 2PCS	R  Back Cushion 2PCS

ASSEMBLY INSTRUCTION

Step 1 Attach right armrest(B) to the seat board(C) using washers(I), bolts(G) and Allen wrench(O). **Hand-tighten all screws to about 80% first. After all screws are in place, tighten them fully in sequence**

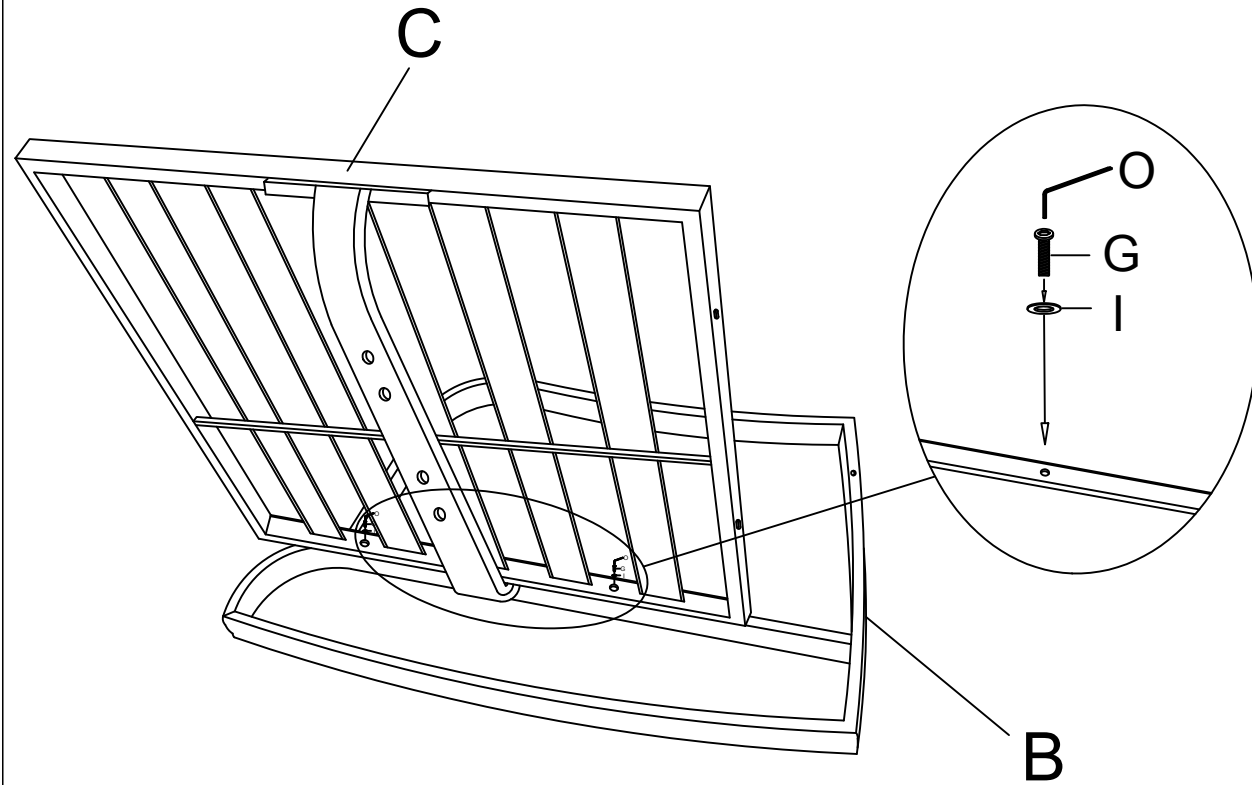
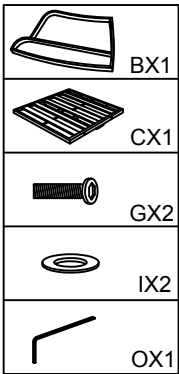

Step 2 Attach back frame(D) to the seat frame using washers(I), bolts(G&H), and Allen wrench(O). **Hand-tighten all screws to about 80% first. After all screws are in place, tighten them fully in sequence**

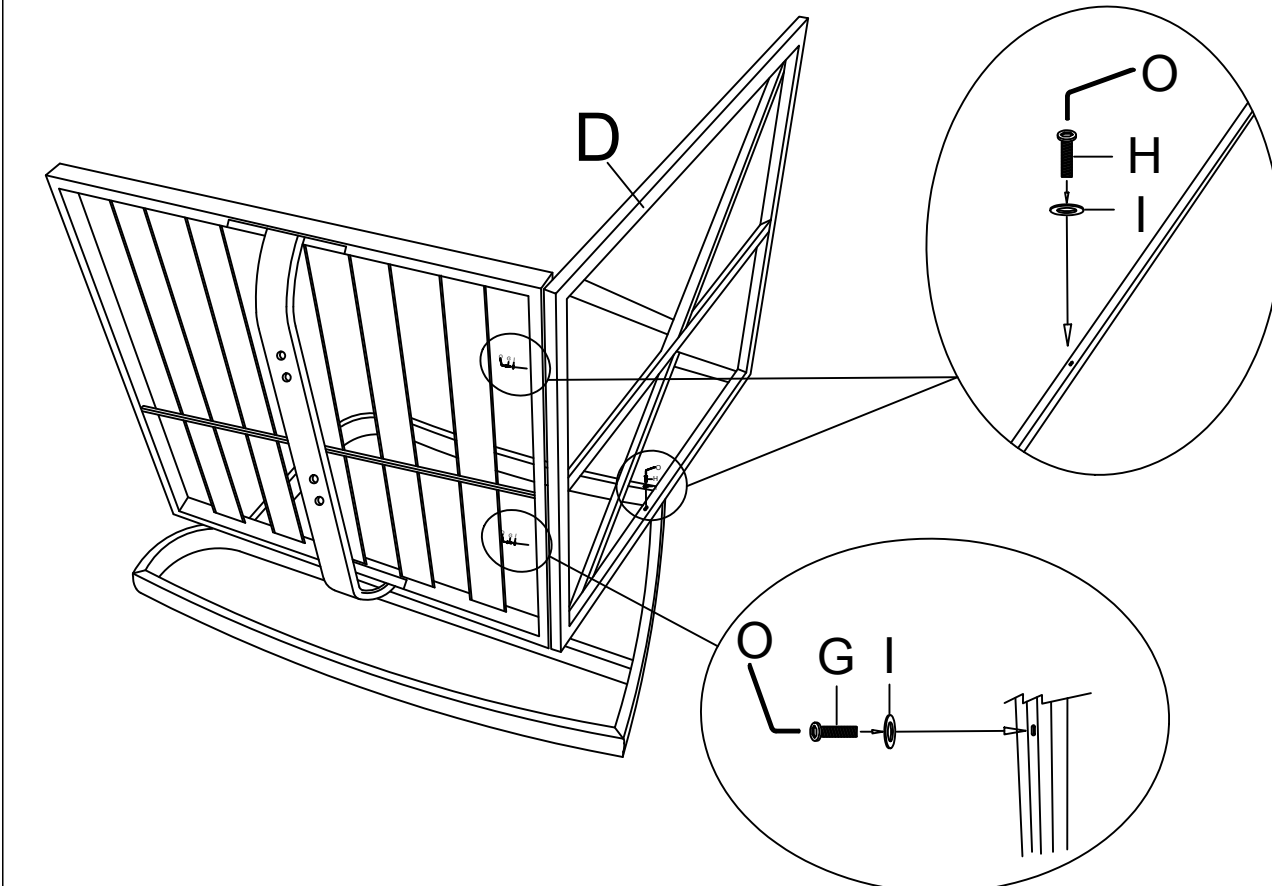
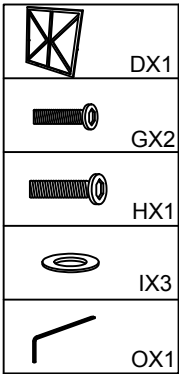

ASSEMBLY INSTRUCTION

Step 3 Attach left armrest(A) to the seat board(C) using washers(I), bolts(G&H) and Allen wrench(O). **Hand-tighten all screws to about 80% first. After all screws are in place, tighten them fully in sequence**

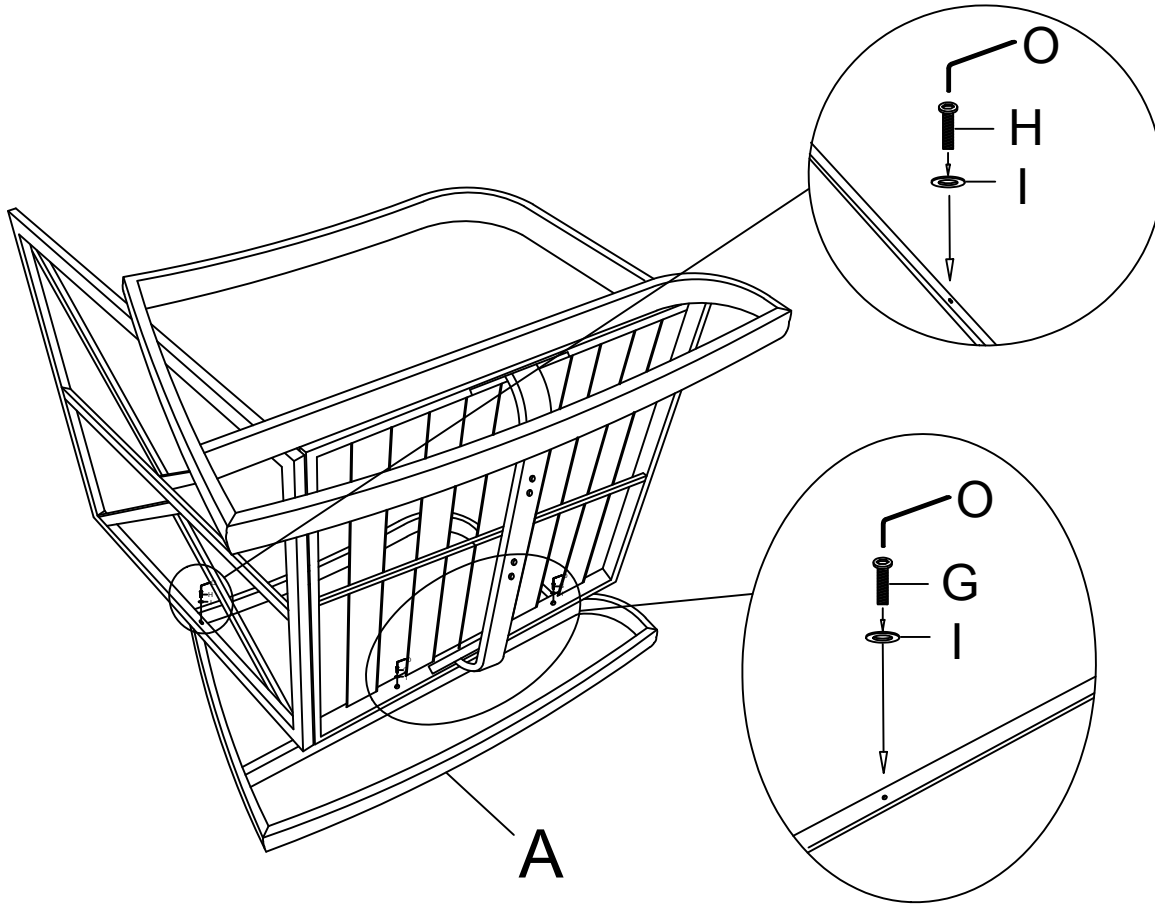

	AX1
	GX2
	HX1
	IX3
	OX1



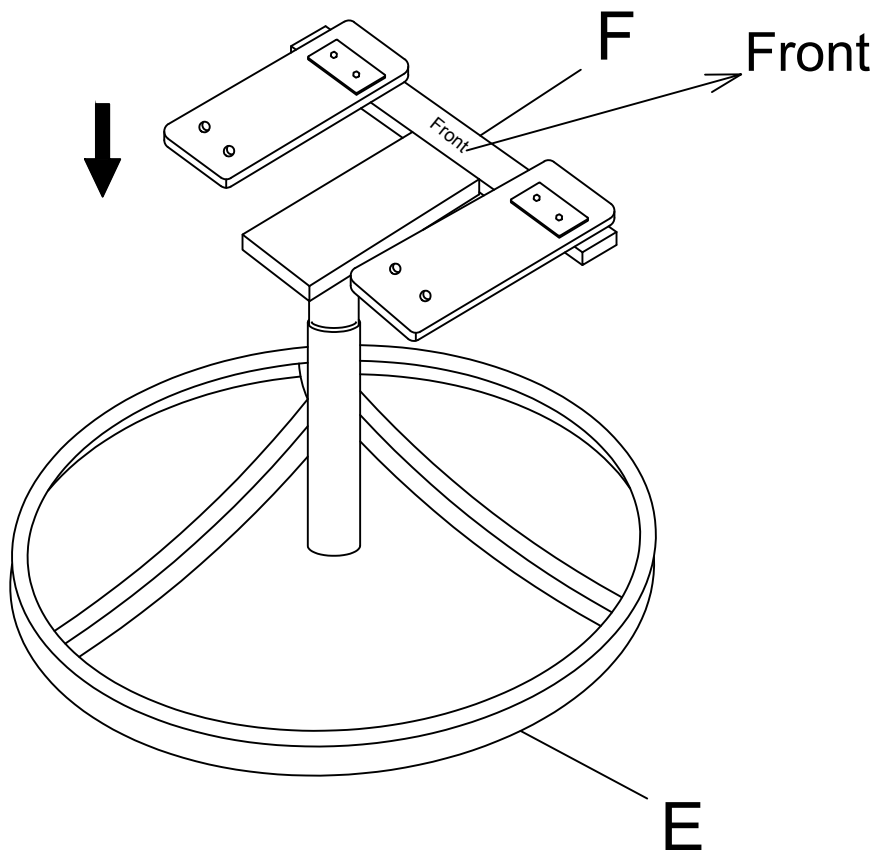



Step 4 Attach rotate board(F) to the base(E).



	EX1
	FX1



ASSEMBLY INSTRUCTION

Step 5 Attach seat frame to the base using nuts(M), spring washers(L), washers(K), iron plates(N), bolts(J) and wrench(P).

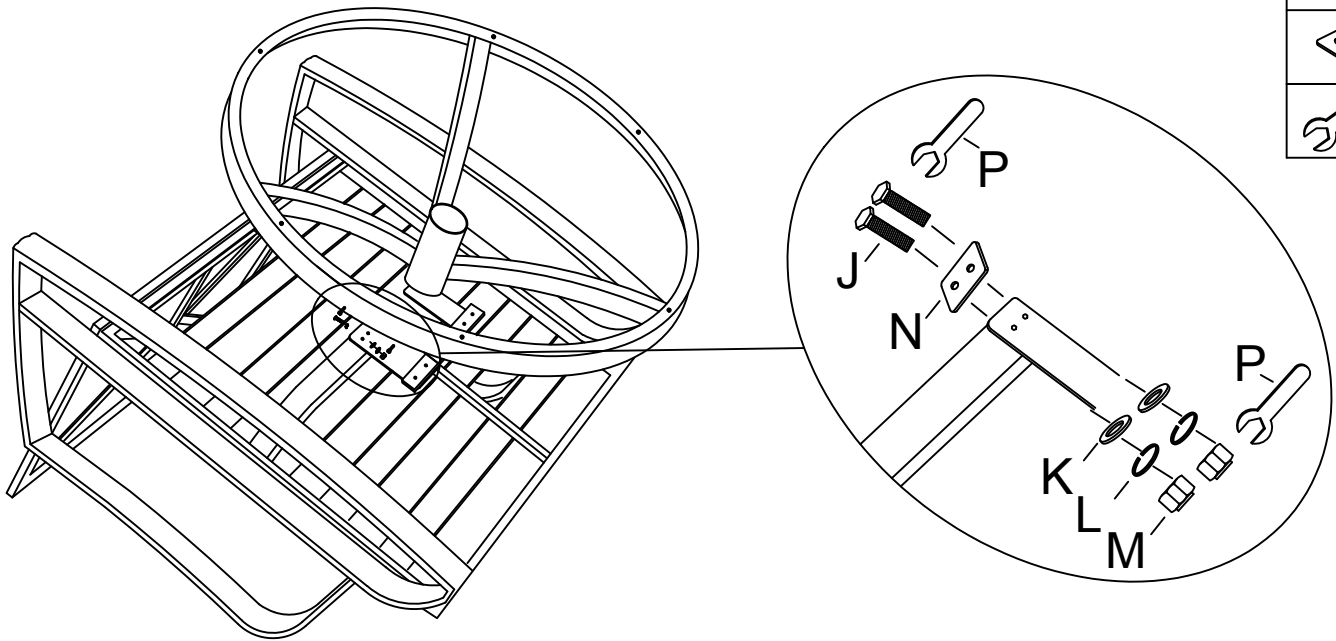
	JX4
	KX4
	LX4
	MX4
	NX2
	PX2

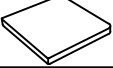

Step 6 Tighten all bolts 100%, and flip the seat over. Put the seat cushion(Q) and back cushion (R) on the seat frame. The assembly is done.

	QX1
	RX1

