

# Pantry

Assembly Instructions - Please keep for future reference

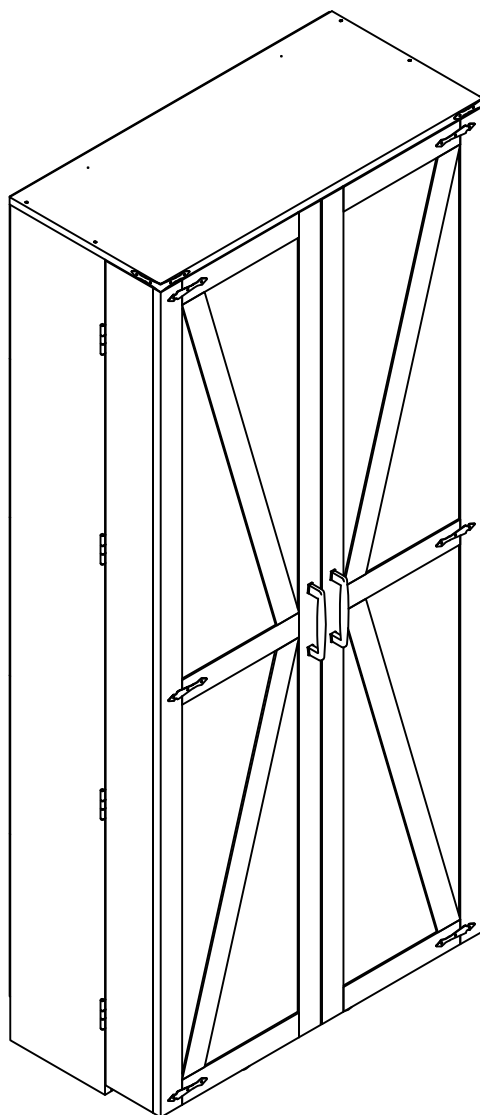

## Dimensions

Width - 29.5inch

Depth - 13.9inch

Height - 66.9inch

Important – Please read these instructions fully before starting assembly



# Safety and Care Advice

**Important – Please read these instructions fully before starting assembly**

- Check you have all the components and tools listed on the following pages.
- Remove all fittings from the plastic bags and separate them into their groups.
- Keep children and animals away from the work area, small parts could choke if swallowed.
- Make sure you have enough space to layout the parts before starting.

- During assembly do not stand or put weight on the product, this could cause damage.
- Assemble the item as close to its final position (in the same room) as possible.
- Assemble on a soft level surface to avoid damaging the unit or your floor.
- Parts of the assembly will be easier with 2 people.



- To reduce the likelihood of damaging your product please ensure that your power drill is set on a low torque setting.

## Care and maintenance

- Only clean using a damp cloth and mild detergent, do not use bleach or abrasive cleaners.
- From time to time check that there are no loose screws on this unit.
- This product should not be discarded with household waste. Take to your local authority waste disposal centre.

## Handy Hints

- Assemble all parts and bolts loosely during assembly, only once the product is complete should you fully tighten the bolts
- Regularly check and ensure That all bolts and fittings are tightend properly.

## **WARNING** In order to help prevent overturning – please follow these instructions

To help prevent product toppling over please follow the below steps:-

Use the anti tip stap or wall fixing method provided (if applicable)  
Do not allow children to climb or hang on the furniture  
Do not open more than one drawer at a time  
Do not place heavy items in the top drawers  
Do not place heavy items on top of the furniture, unless the furniture has been designed for this purpose

please note that only the anti tip strap is provided.  
You will need to provide wall plugs and screws applicable for your wall type

# Components - Panels

Please check you have all the panels listed below

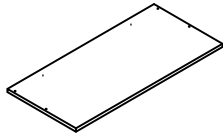

1 (750X351X15mm)X1

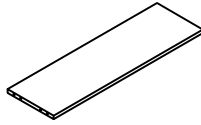

2 (717X220X15mm)X1

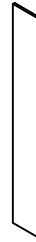

3 (1685X220X15mm)X1

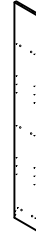

4 (1685X220X15mm)X1

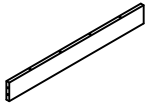

5 (717X85X15mm)X2

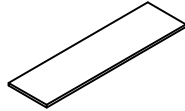

6 (711X195X12mm)X2

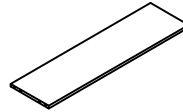

7 (717X195X12mm)X2

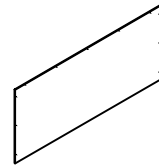

8 (744X327.5X3mm)X2

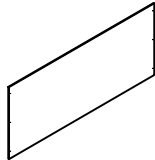

9 (744X319X3mm)X1

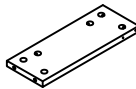

10 (295X110X15mm)X1

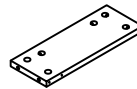

11 (295X110X15mm)X1

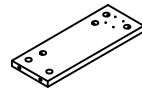

12 (295X110X15mm)X1

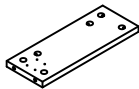

13 (295X110X15mm)X1



14 (1662X110X15mm)X1



15 (1662X110X15mm)X1



16 (1662X110X15mm)X1



17 (1662X110X15mm)X1

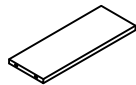

18 (295X110X12mm)X6

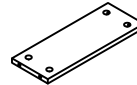

19 (295X110X12mm)X4



20 (1662X372X18mm)X1

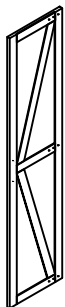

21 (1662X372X18mm)X1

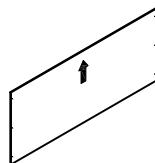





















22 (744X317X3mm)X2

# Components - Fittings

Please check you have all the hardware listed below

Note: The quantities below are the correct amount to complete the assembly. In some cases more fittings may be supplied than are required.

<b>A</b>  Male Camlock x 88	<b>B</b>  Female Camlock x 88	<b>C</b>  Dowel x 56
<b>D</b>  Ø5 x 40mm x 4	<b>E</b>  Magnet Touch x 2	<b>F</b>  x 2
<b>G</b>  3*14mm Screw x 34	<b>H</b>  x 8	<b>J</b>  3.5*14mm Screw x 40
<b>K</b>  x 2	<b>L</b>  x 8	<b>M</b>  x 12
<b>N</b>  x 2	<b>P</b>  x 4	<b>Q</b>  x 40
<b>R</b>  x 4	<b>S</b>  Wall Fixing Pack x 2	<b>T</b>  x 2
<b>U</b>  x 6	<b>V</b>  x 1	<b>W</b>  3*16mm Screw x 4

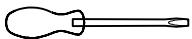

Tools required



Phillips screwdriver  
(medium & large)

Ruler - Use this ruler to help correctly identify the screws

0 5 10 15 20 25 30 35 40 45 50 55 60 65 70 75 80 85 90 95 100 105 110 115 120 125 130 135 140 145 150 155 160 165 170

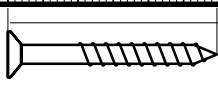

The screws length is measured from the head to the point (30mm screw shown).

# Using Camlocks

## Step 1

Connect the male camlock as directed in the assembly instructions using a screwdriver.

1

DO NOT OVER TIGHTEN.  
NE PAS SERRER EXCESSIVEMENT.

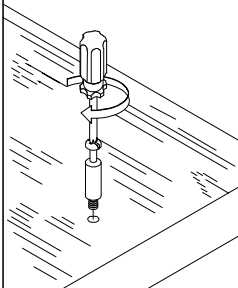

## Step 2

Push the male camlock into the entry hole.

2

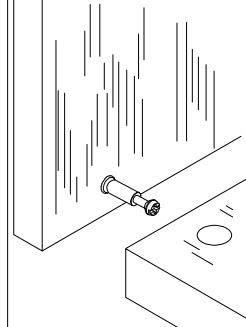

## Step 3

Insert the female camlock as shown in the instruction.

Note: ensure that the arrow on the top of the camlock points towards the entry hole for the male camlock.

3

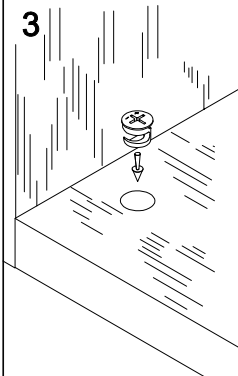

## Step 4

Turn the female camlock clockwise with a screwdriver.

You should feel a click when the camlock is locked in place.

The joint is now secure.

4

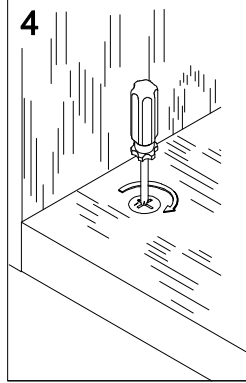

# Assembly Instructions

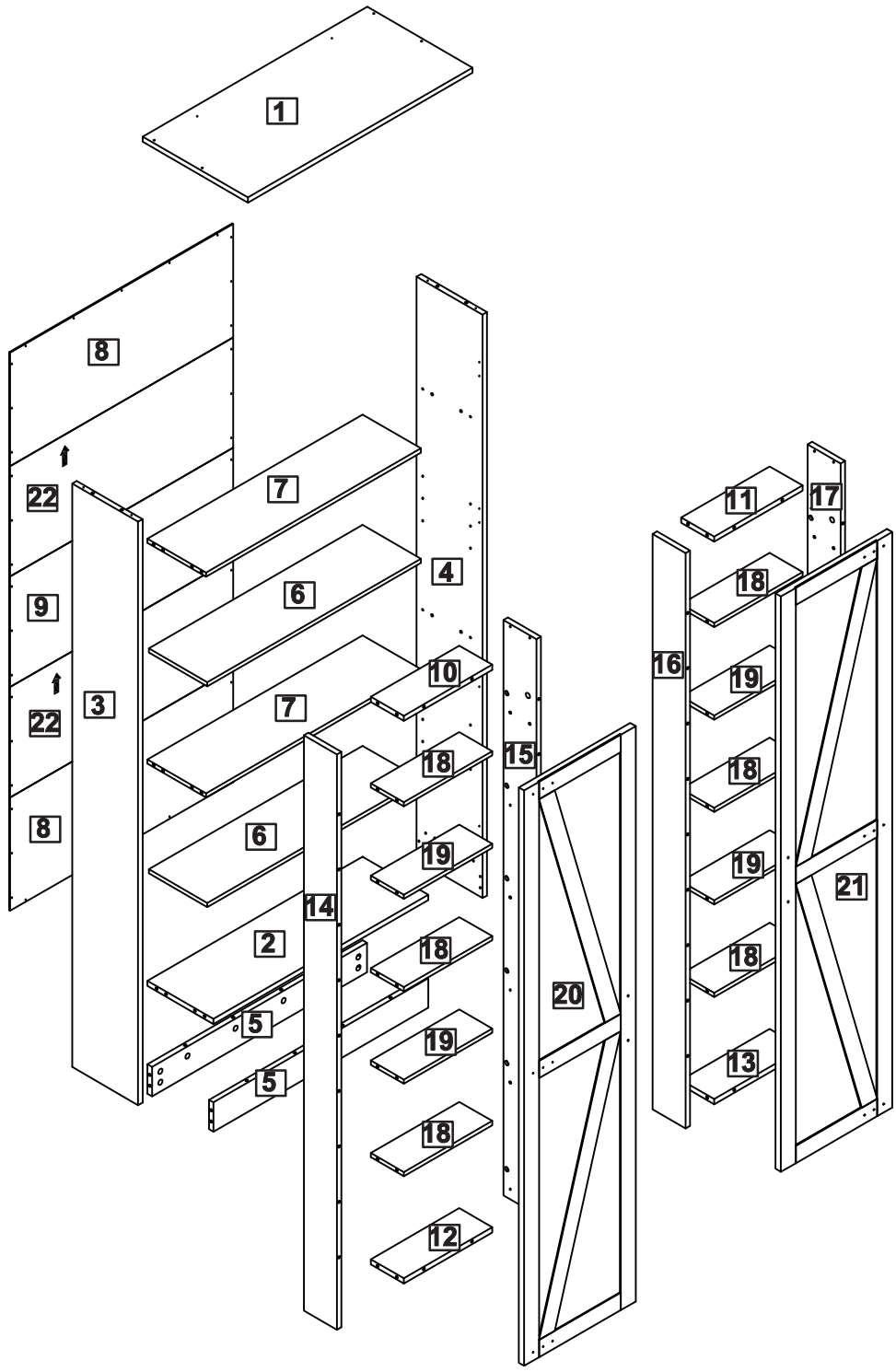

# Assembly Instructions

## Step 1

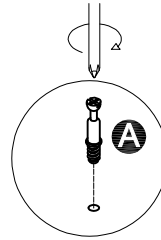
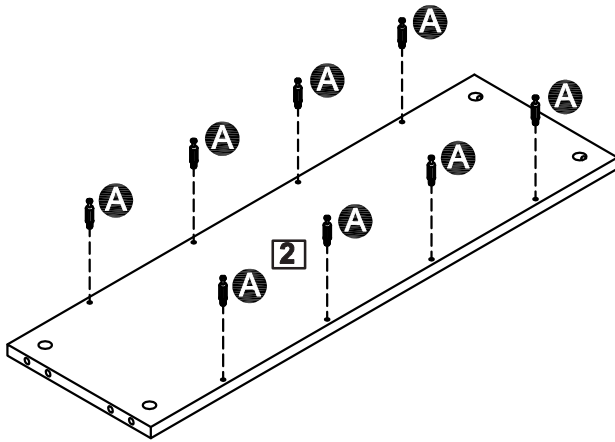
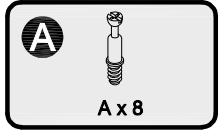

## Step 2

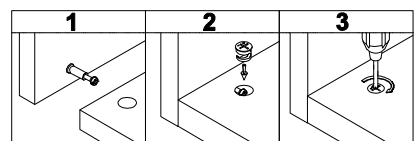
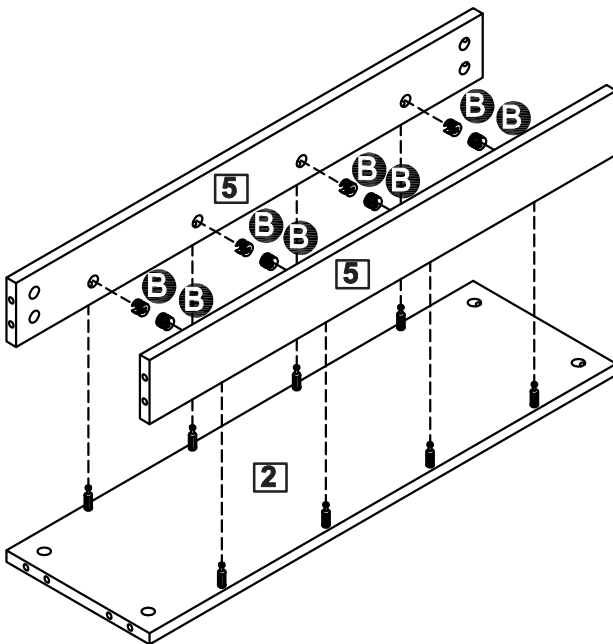

# Assembly Instructions

## Step 3

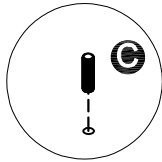
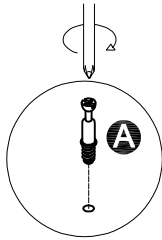
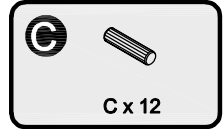
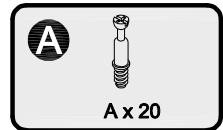
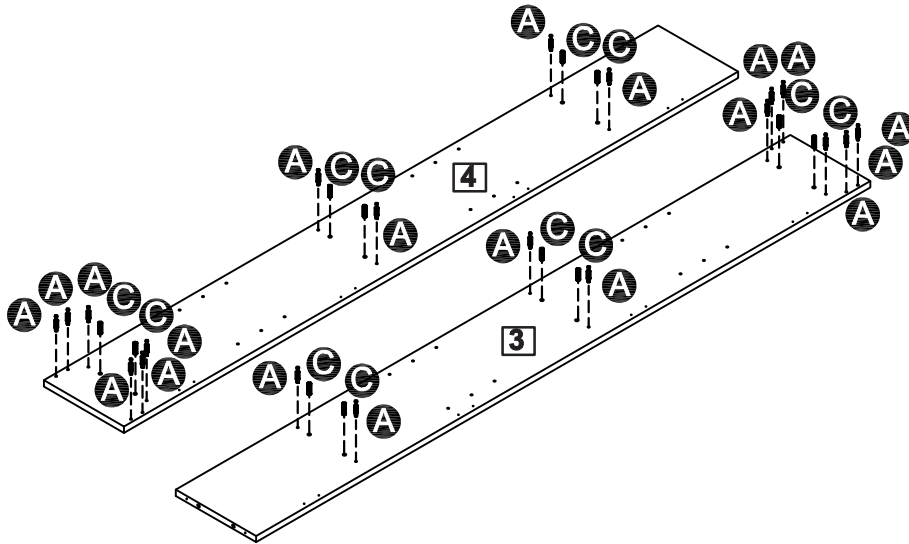

## Step 4

Note the hole orientation of part 7, as shown in the diagram

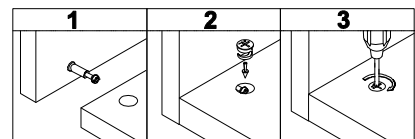
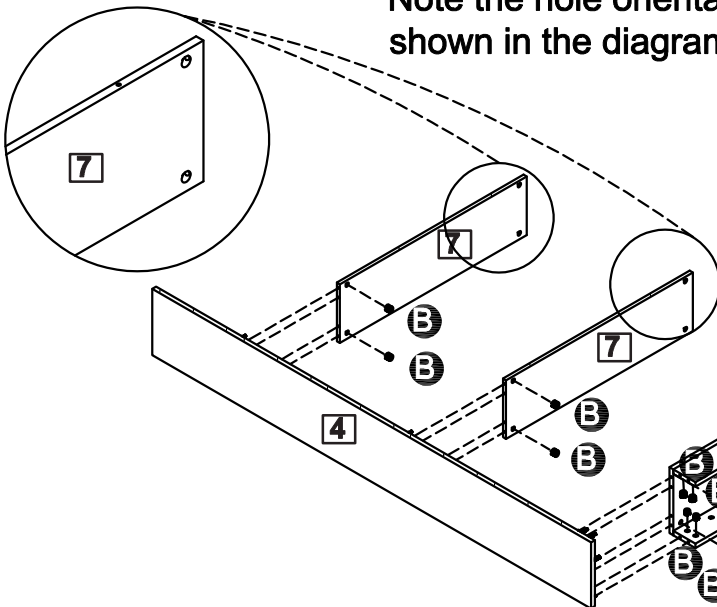

# Assembly Instructions

## Step 5

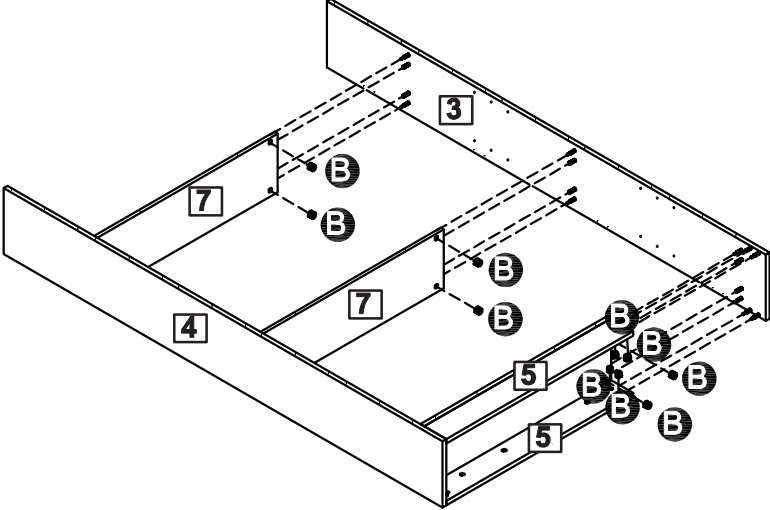
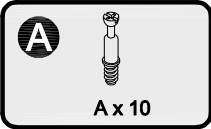

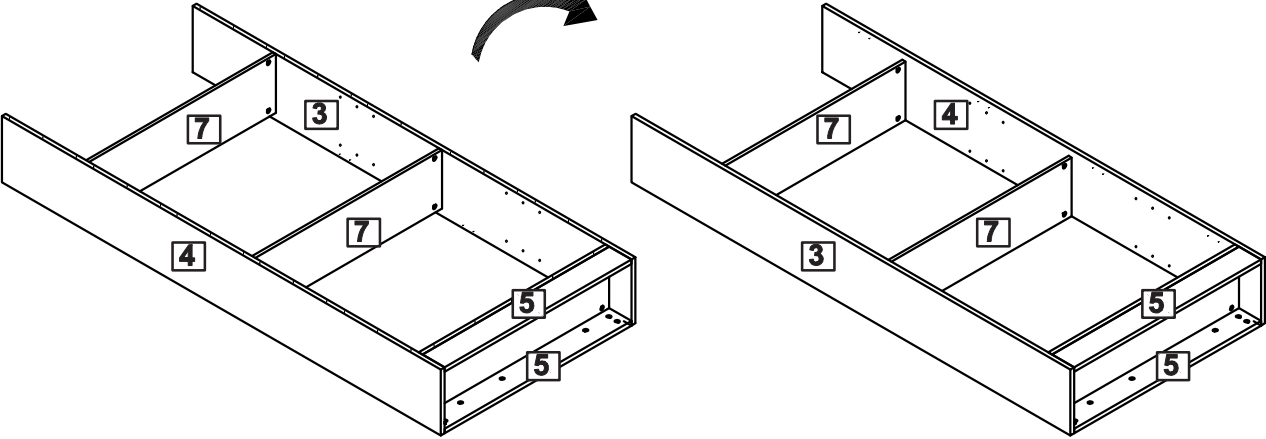

## Step 6

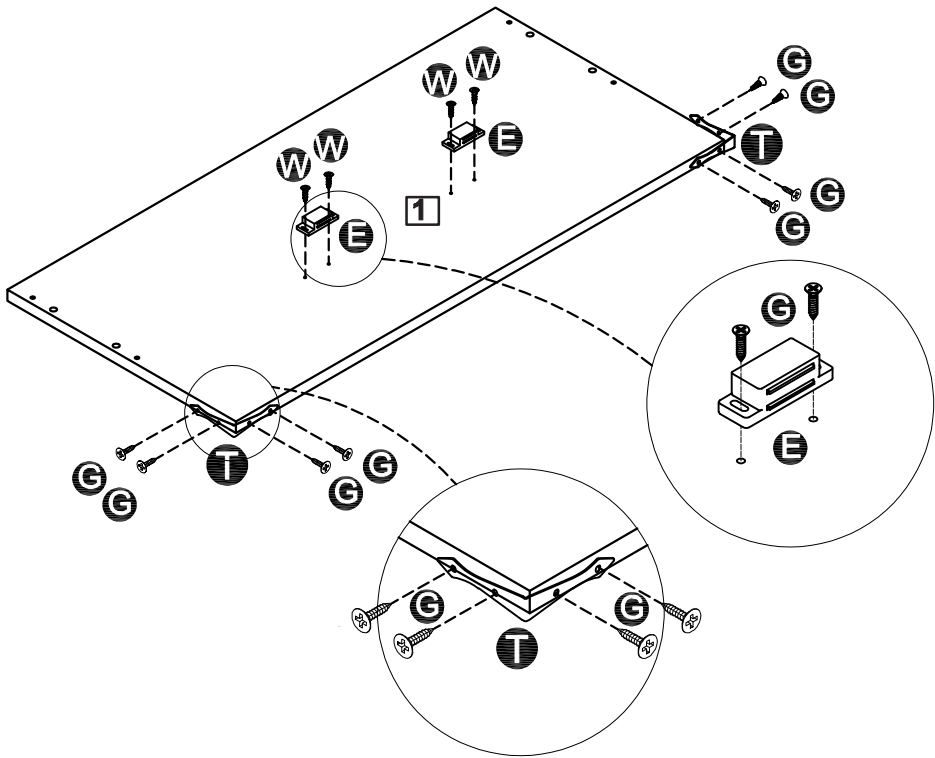

# Assembly Instructions

## Step 7



**E**   
L x 2

**G**   
G x 8

**T**   
L x 2

**W**   
W x 4

## Step 8

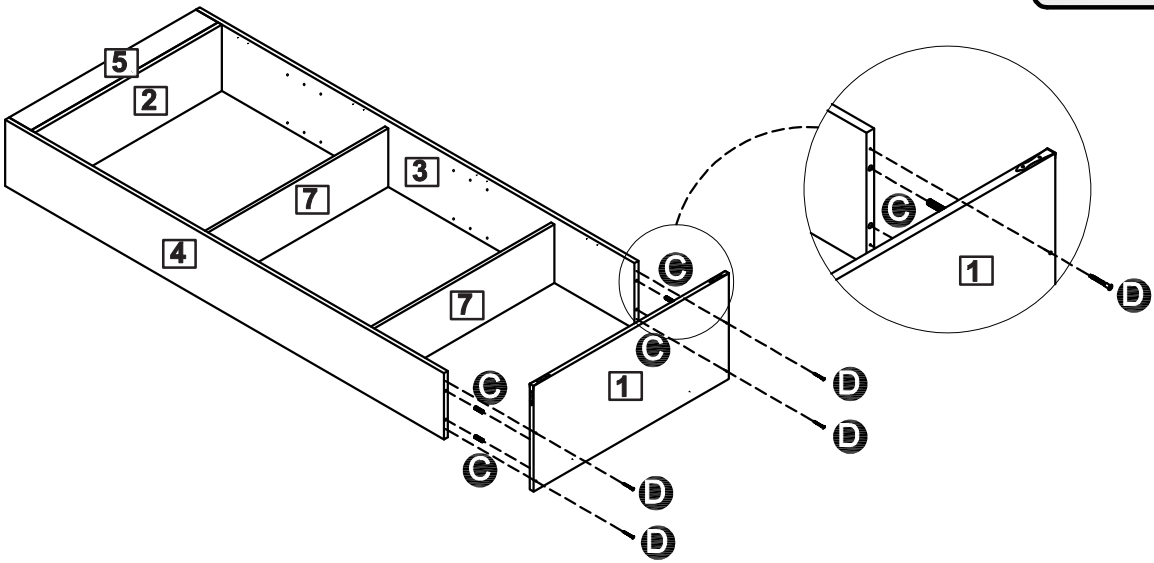

**C**   
C x 4

**D**   
D x 4

# Assembly Instructions

## Step 9

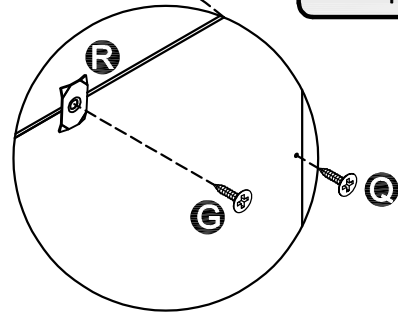
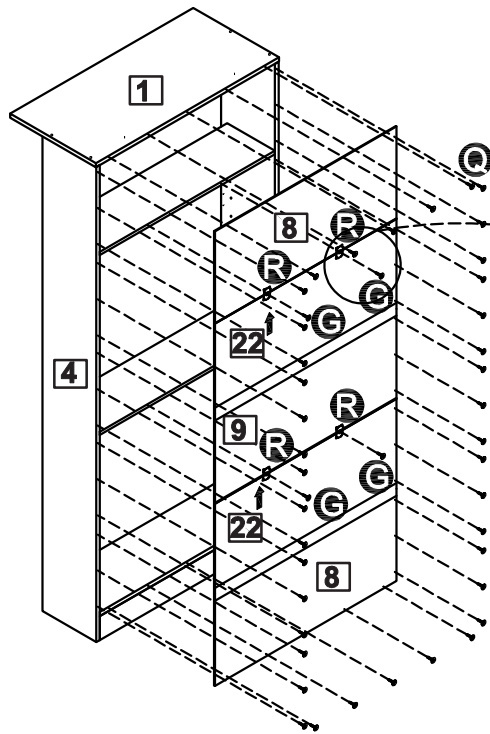

## Step 10

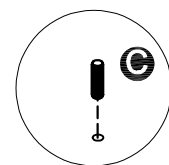
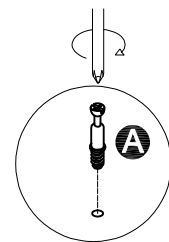
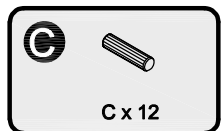
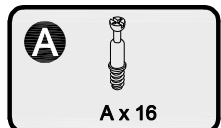
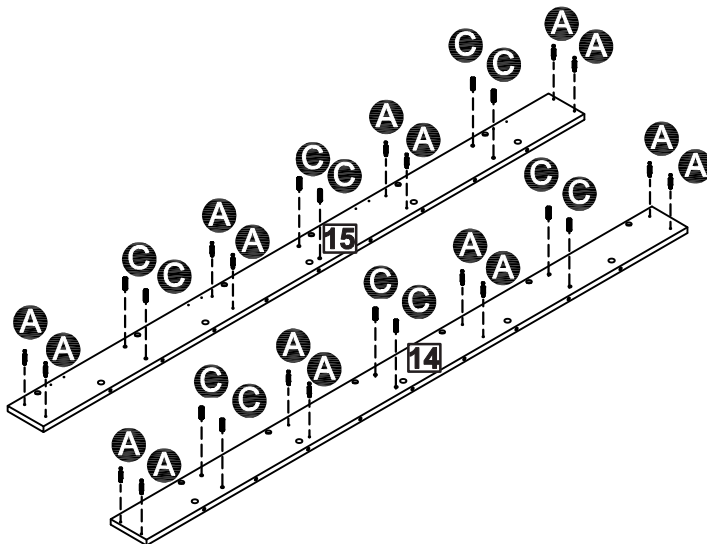

# Assembly Instructions

## Step 11

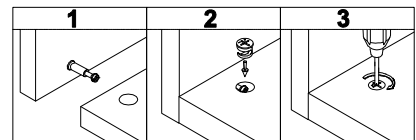
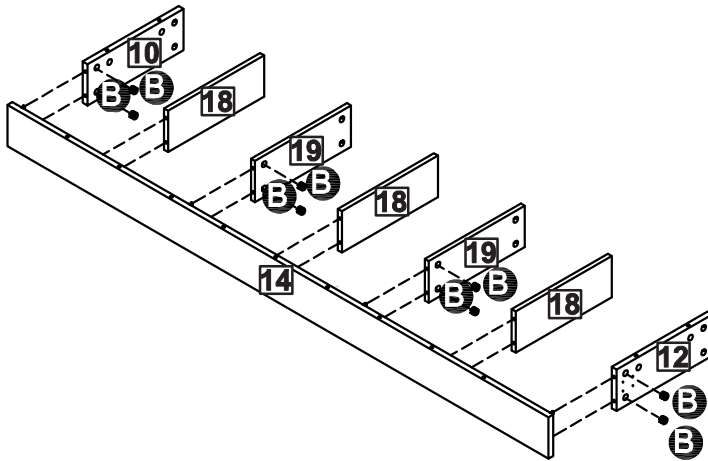

## Step 12

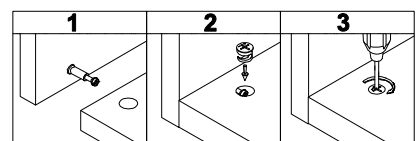
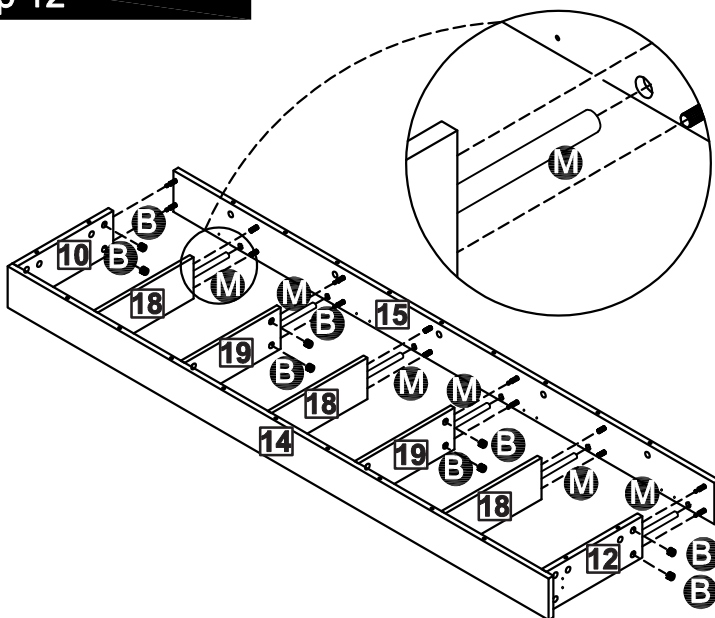
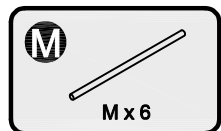

# Assembly Instructions

## Step 13

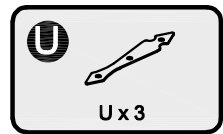
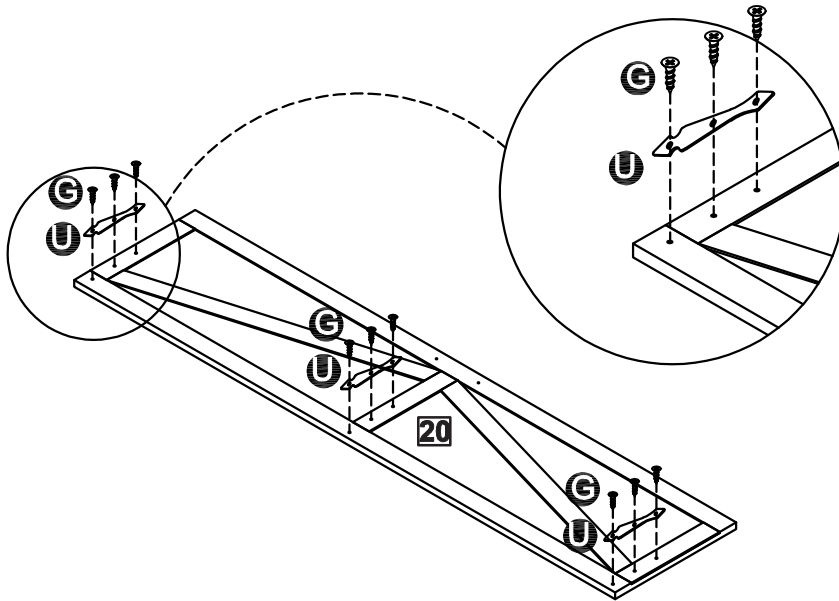



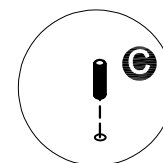
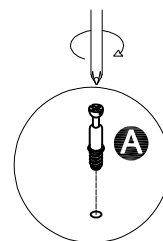
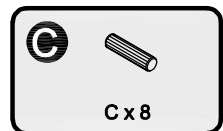
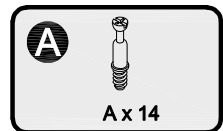
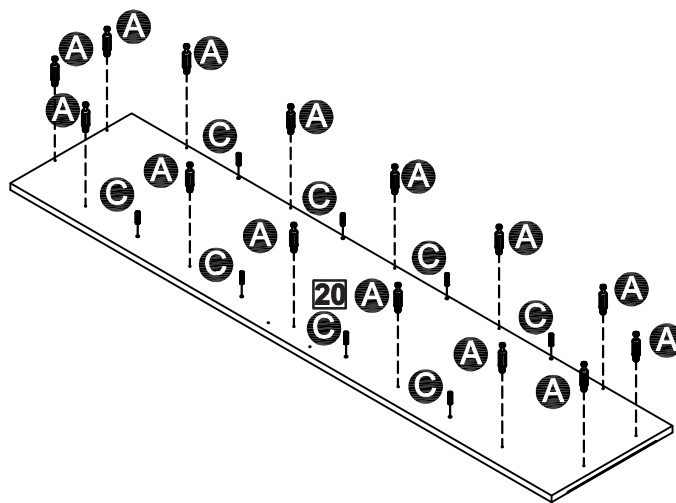

## Step 14

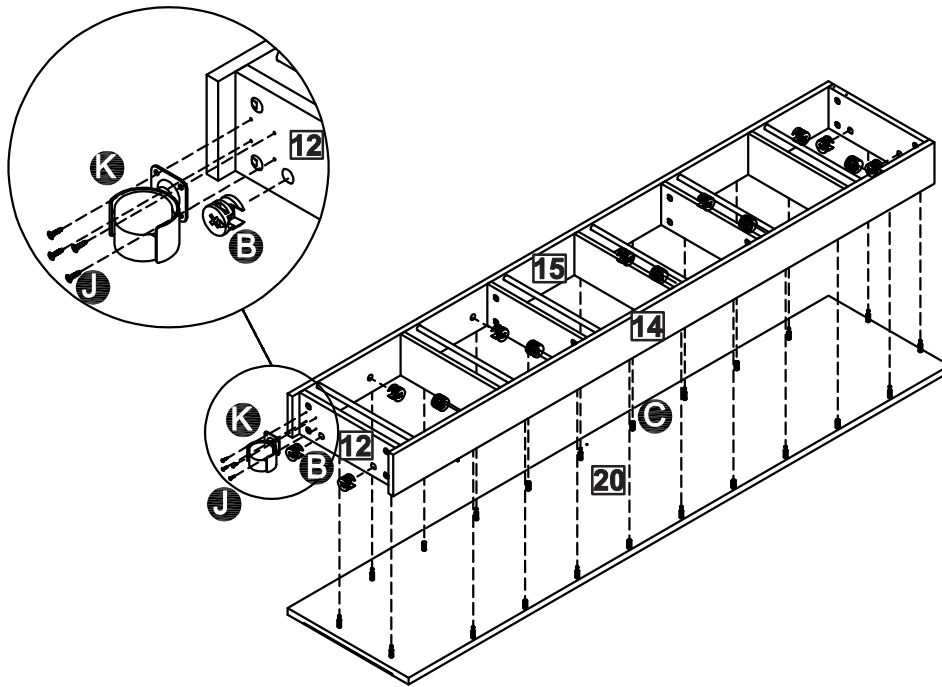

# Assembly Instructions



## Step 15

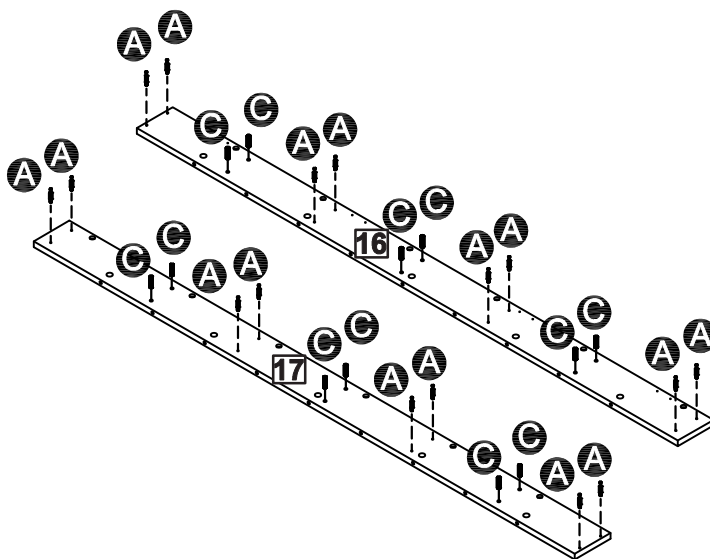

- B**    
 B x 14
- J**    
 J x 4
- K**    
 K x 1

## Step 16



- A**    
 A x 16
- C**    
 C x 12

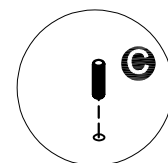
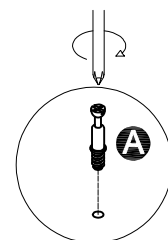

# Assembly Instructions

## Step 17

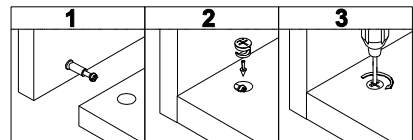
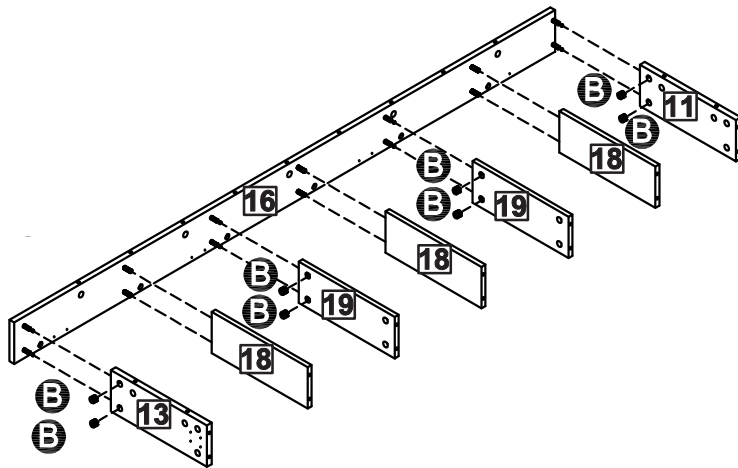

## Step 18

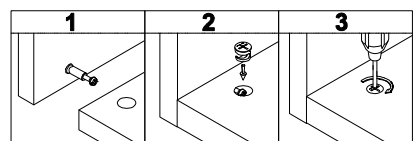
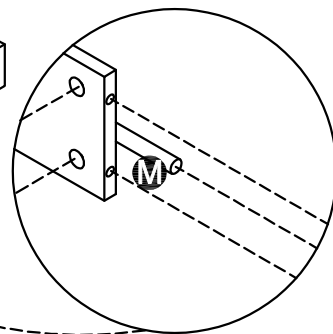
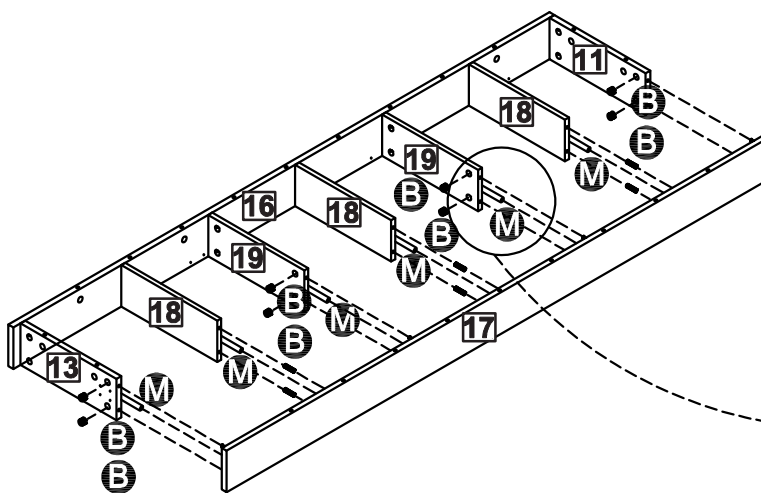
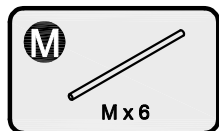

# Assembly Instructions

## Step 19

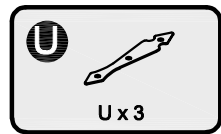
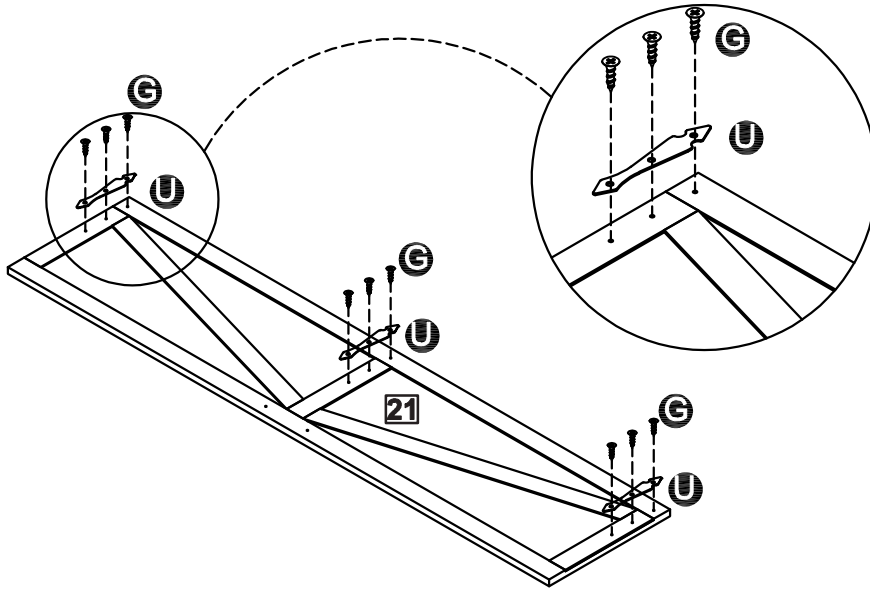



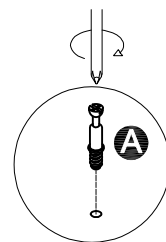
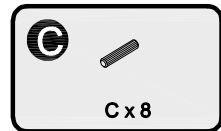
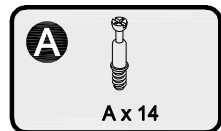
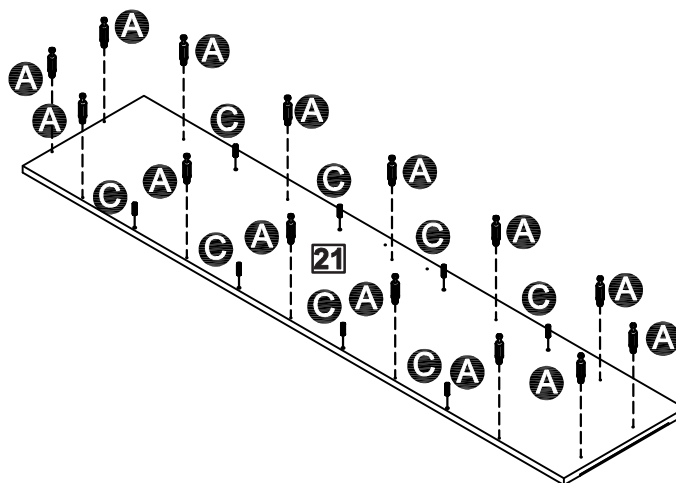

## Step 20

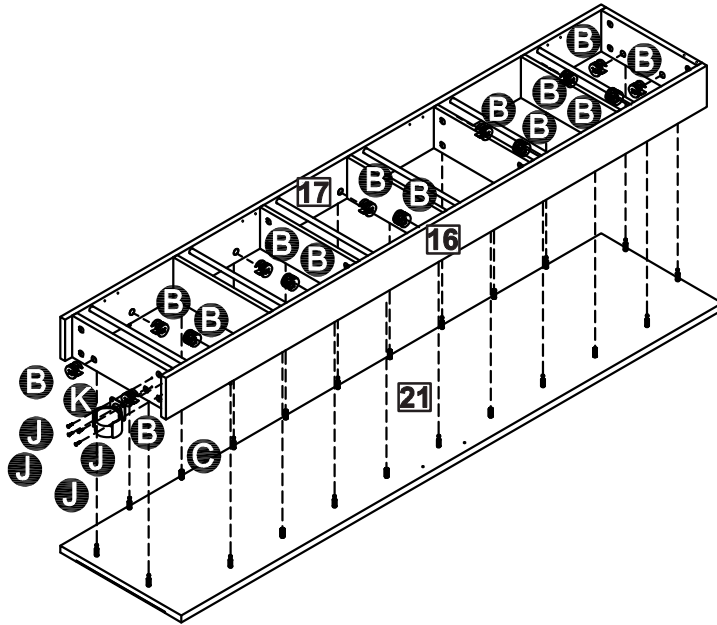

# Assembly Instructions

## Step 21





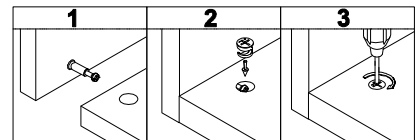

- B**    
 B x 14
- J**    
 J x 4
- K**    
 K x 1

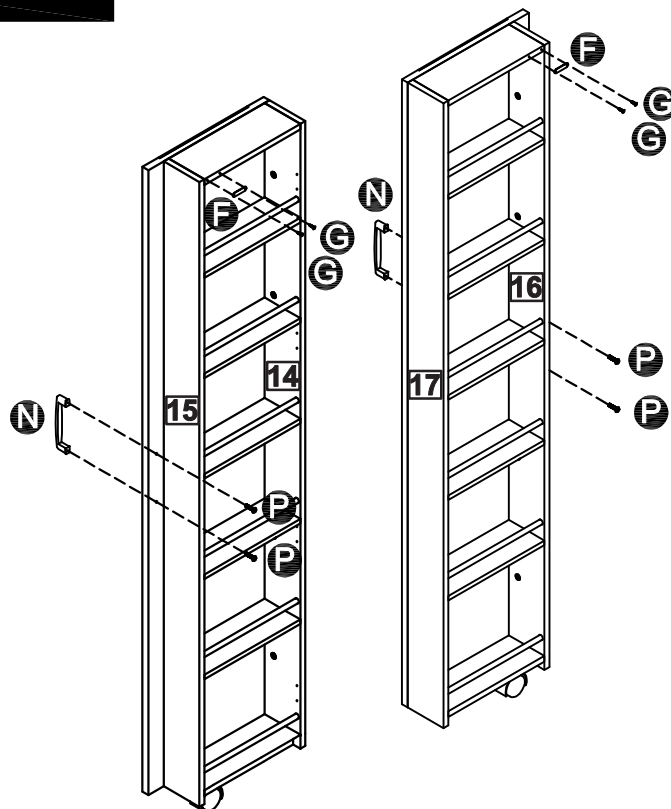

## Step 22



- N**    
 N x 2
- P**    
 P x 4
- F**    
 F x 2
- G**    
 G x 4

# Assembly Instructions

## Step 23

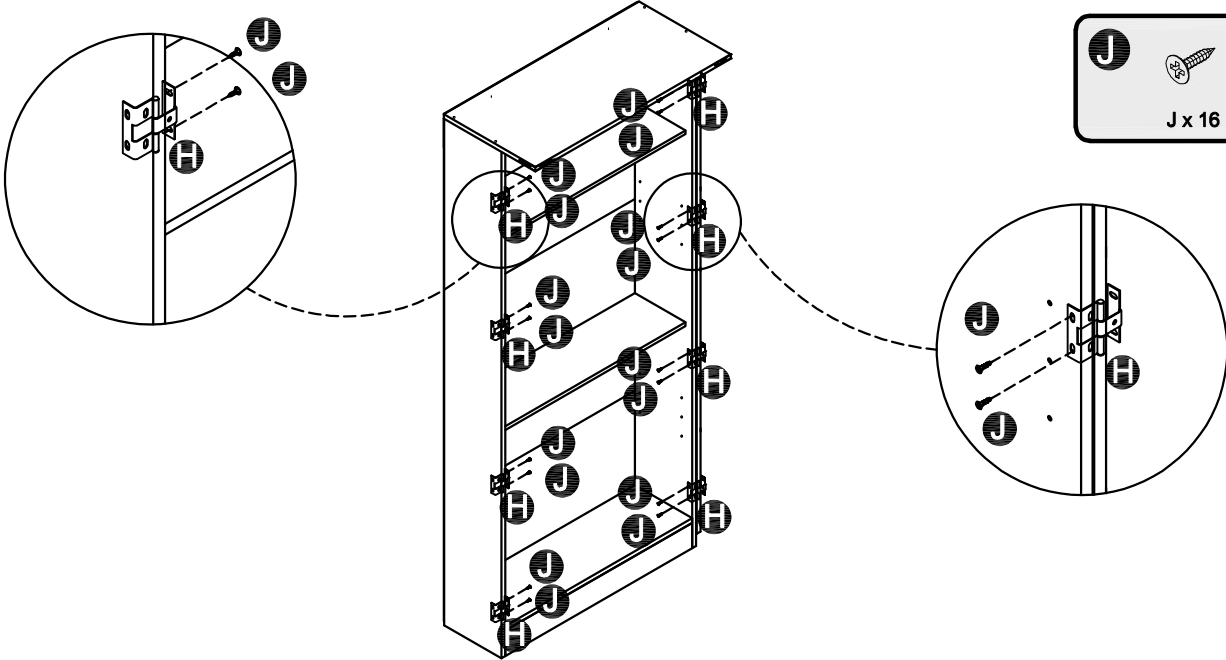

## Step 24

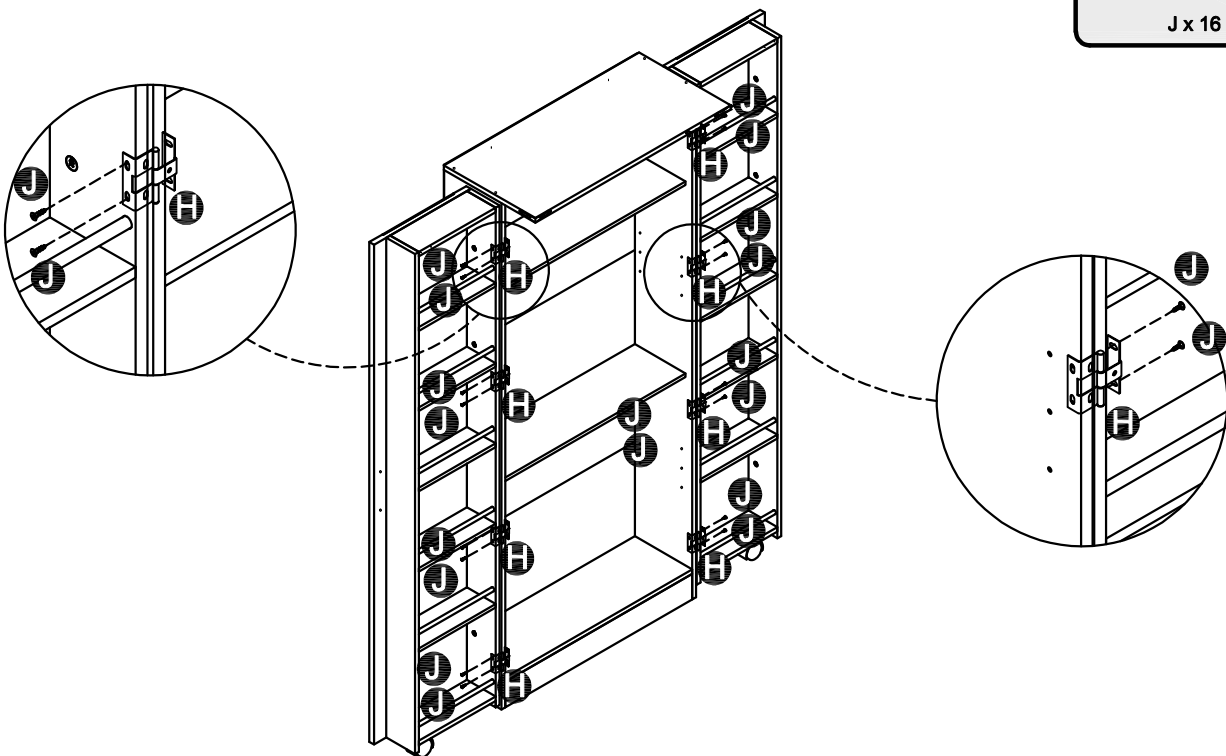

# Assembly Instructions

## Step 25

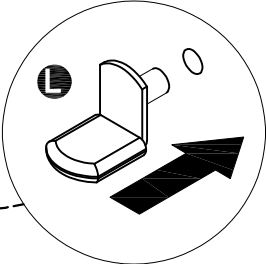
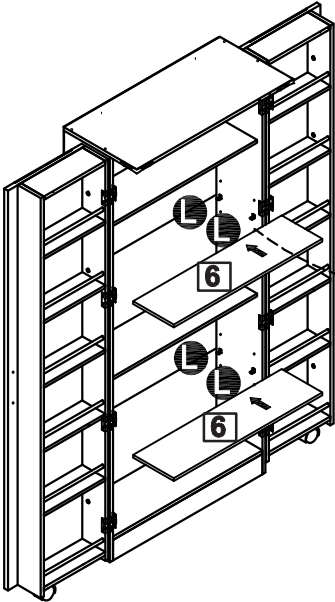

## Step 26

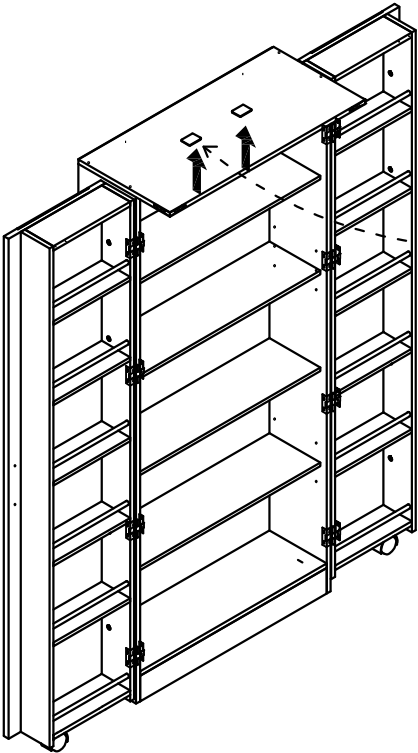
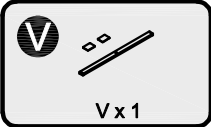

Refer to the included manual for sensor light usage

# Assembly Instructions

## Step 27

 Must be installed with anti-tip hardware for safety

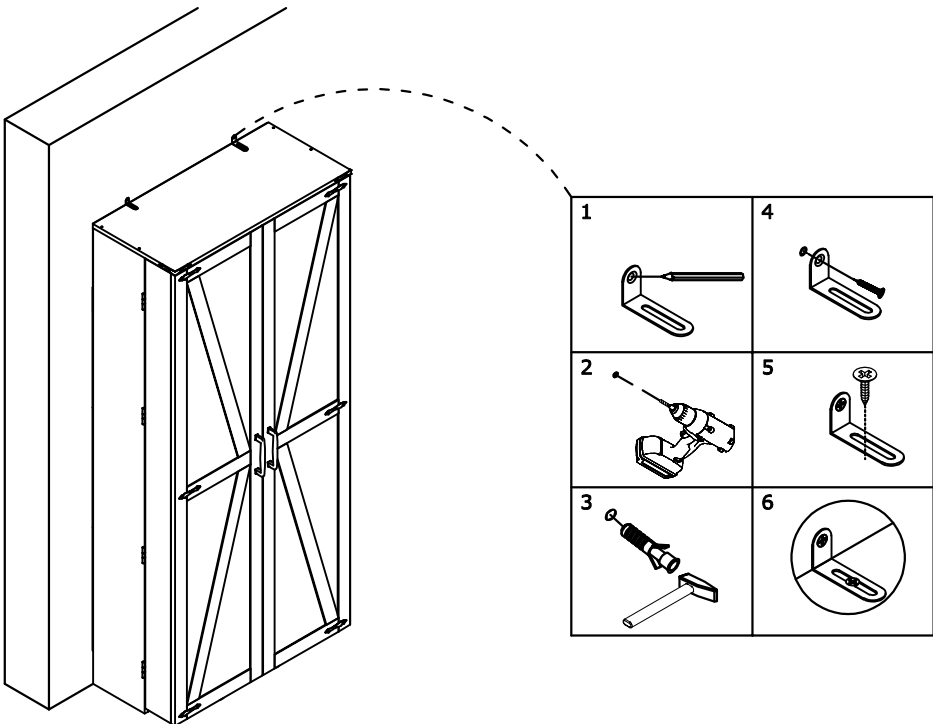

**Assembly is complete.**