



# ASSEMBLY INSTRUCTION

## 47" RECTANGLE DINING TABLE



Thank you for purchasing this quality product. Be sure to check all packing materials carefully for small parts, which may have come loose inside the carton during shipment. Identify and count all items and compare with the parts list and/or hardware list shown below.

**CAUTION**

1. Do not fully tighten the nuts or bolts until the table is fully assembled.
2. Please tighten by hand, not by a drill. Overtightening will damage threads. Do not overtighten.
3. Keep all hardware out of the reach of children.

PARTS LIST		
NO	DESCRIPTION	QTY
A	TABLE TOP WITH APRON 	1 PC
B	TABLE LEG 	4 PCS

HARDWARE LIST		
NO	DESCRIPTION	QTY
1	HEX NUT 5/16" 	8 PCS
2	SPRING WASHER 5/16" 	8 PCS
3	FLAT WASHER 5/16" 	8 PCS
4	WRENCH 12.8 	1 PC

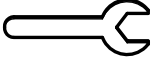
**STEP 1**

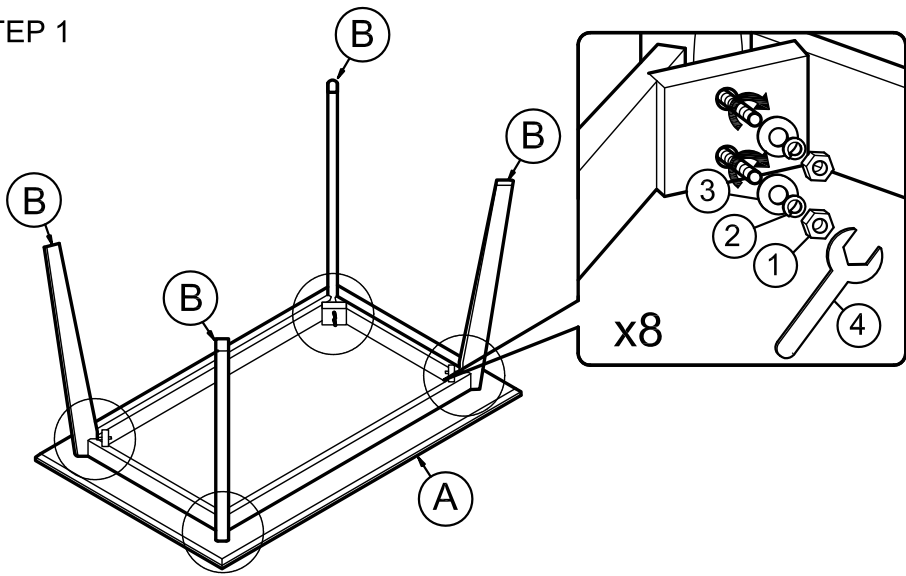

Tools needed for assembly (not included) :

