

Hanging Chair

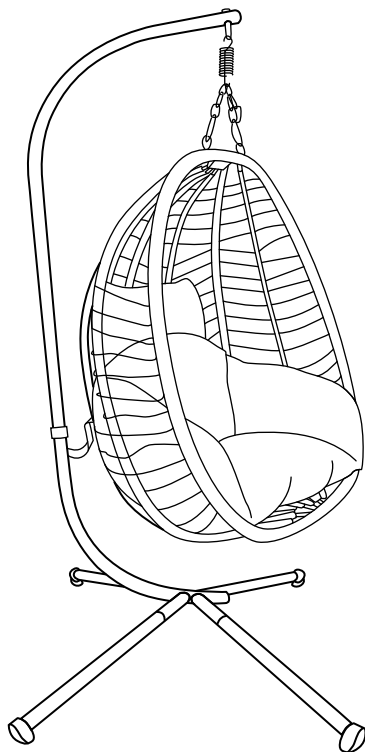

01HC23-G



IMPORTANT

PLEASE READ BEFORE YOU COMMENCE ASSEMBLY
Follow the guidelines in this user guide to ensure correct
assembly and care for this product

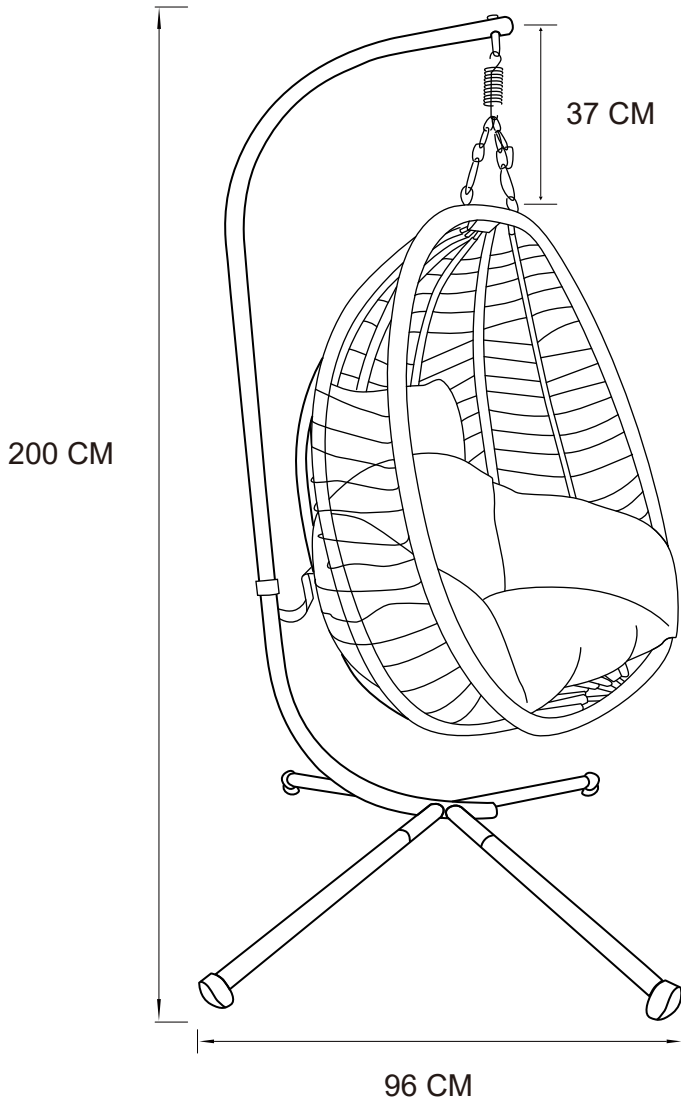



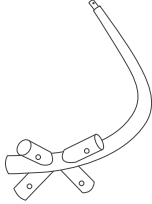

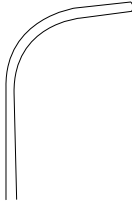
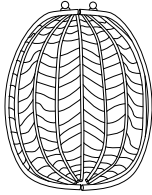
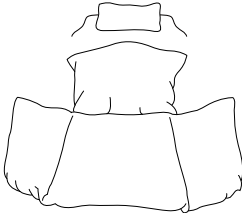





PARTS AND SPECIFICATIONS





PARTS LIST

Part	Description	Description	Qty
A		Base Support Bar	1PC
B		Leg Bars	4PCS
C		Suspension Rod	1PC
D		Hanging Basket	1PC
E		Cushion & Pillow	1PC

PARTS LIST

Part	Description	Description	Qty
F		Round Cap Bar	1PC
G		Double hook spring	1PC
H		Chains	2PCS
I		Hooks	2PCS
J		Bolt M10*60	1PC
K		Bolt M6*15	8PCS
L		Washer M6	12PCS
M		Hexagonal nuts M6	4PCS
N		Wrenches M15	2PCS
O		Wrenches M10	1PC
P		Allen wrench M4	1PC
Q		Safety belts	1PC

Extra





Part	Description	Description	Qty
K		Bolt M6*15	4PCS
L		Wacher M6	8PCS
M		Hexagonal nuts M6	4PCS

WARNING: Failure to locate parts in accordance with these diagrams, or failure to use special parts provided with this equipment, may result in property damage or personal injury.

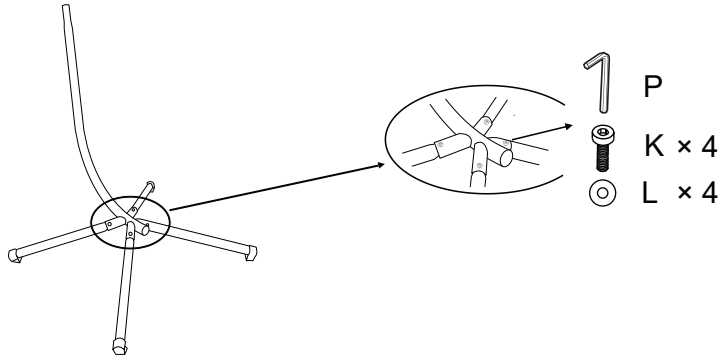
Step 1: Connect the base support bar(A) to the leg bars(B) with screws.

NOTE: Do not use power tools when assembling this product. They may cause damage to fasteners and may affect your warranty.





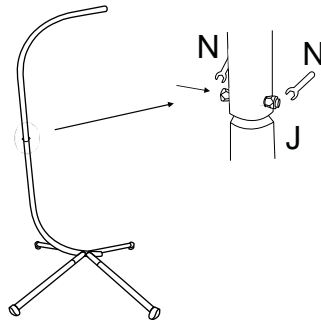

- | | | | | | | | | |
|---|---|----|---|---|-------|----|---|----|
| A |  | x1 | B |  | x4 | L |  | x4 |
| P |  | x1 | K |  | M6x15 | x4 | | |

Step 2: Connect the base support bar(A) to the suspension rod(C) with screws.

NOTE: Please fully tighten all bolts at this time.

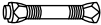



- | | | | | | |
|---|---|----|---|---|----|
| A |  | x1 | C |  | x1 |
| J |  | x1 | N |  | x2 |

Step 3: Unfold the hanging basket (D) and secure it with screws(K).

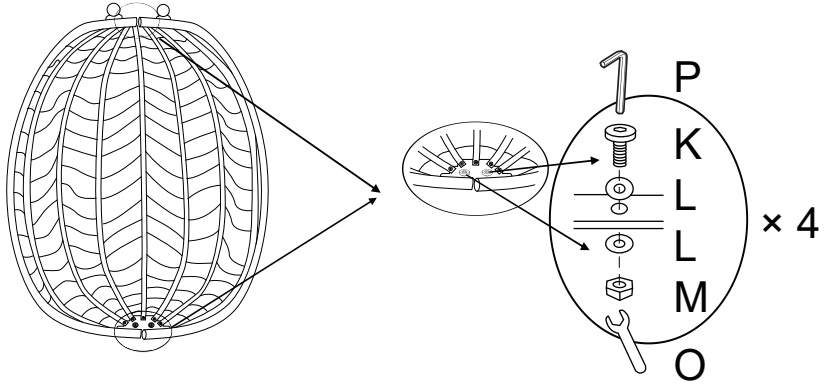



NOTE: Please fully tighten all bolts at this time.

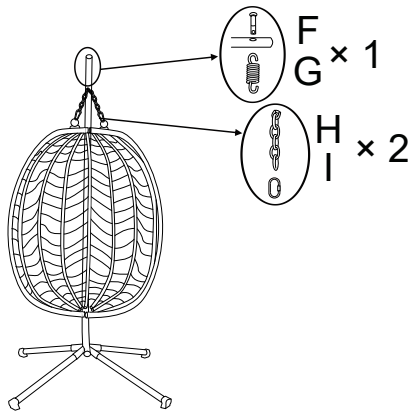

D		x1	L		x8	K		M6x15	x4
P		x1	M		x4	O		M10	x1

Step 4: Install the chain and hook on the suspension bar and hang the basket on it.



F		x1	G		x1
H		x2	I		x2

Step 5: Use the safety belts(Q) to connect the hanging basket(D) and suspension rod(C), and put the cushion & pillow(E) into the basket.

NOTE: Please adjust the sofa cushions to the right height.

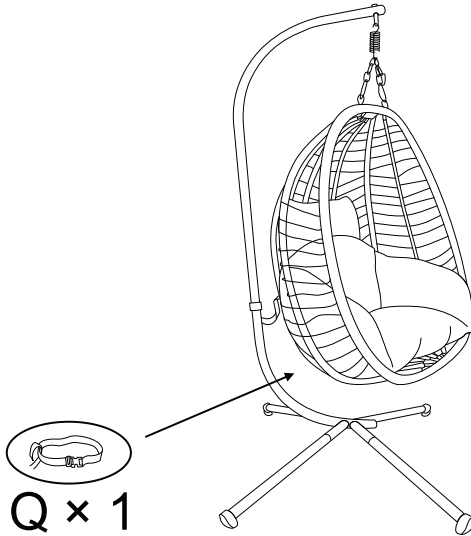

Q × 1

Q



x1

CARE & MAINTANCE

Depending on the amount of use this product received,it may be necessary to tighten the fixings from time to time.

This is normal for any flat pack furniture.

For cleaning,use a damp cloth(not wet),dry duster and normal furniture polish.

Note:

- Design and specifications are subject to change without notice.
- Weight and dimension shown are approximate.