

ASSEMBLY INSTRUCTIONS

Laguna Wall Sconce (Item# II155-0145)

Caution:

- **FOR YOUR SAFETY:** Turn off the power to main electric circuit/ fuse box before beginning work.

Important Safety Instructions:

- **Professional installation is recommended for hardwired lighting. Incorrect installation can lead to fires.**
- These instructions are provided for your safety. It is very important that they are read carefully and completely before assembling fixture.
- We strongly recommend that two people install the lighting fixture.
- This fixture has been rated for up to (1) **40-watt maximum TYPE B bulbs** or (1) **LED 4-watt LED light bulbs** (not included). To avoid the risk of fire, do not exceed the recommended wattage.
- This lighting fixture is intended for indoor, residential use.

Warning:

- To reduce the risk of fire, electrical shock or personal injury, do not turn on lighting fixture until light bulb is installed and assembly is complete.
- Always turn off the lighting fixture and allow it to cool before replacing the light bulb.





Care Instructions:

- Do not polish or use harsh cleaners as they may damage the finish.
- Wipe clean with a non-colored, lint-free soft, dry cloth.

Pre-assembly:



- Remove all parts and hardware from box along with any plastic protective packaging.
- Check that all parts listed are included.
- Do not discard any contents until after assembly is complete to avoid accidentally discarding small parts or hardware.

Component List

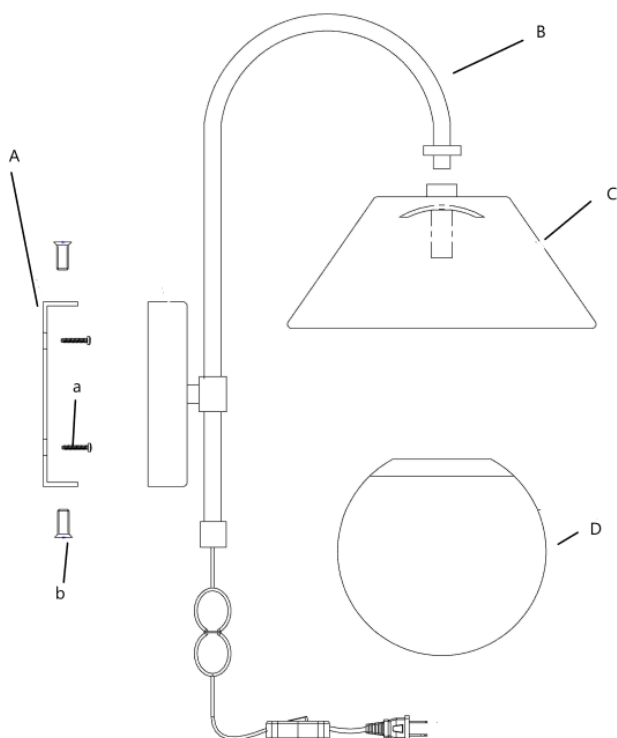
Part code	Component	Description	Qty
A		Mounting plate	1
B		Body with clear cord	1
C		Rattan shade with socket	1
D		Shade	1

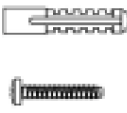

Hardware List

Part code	Component	Description	Qty
a		plastic screw anchors and grub screws	4
b		Mounting screw	2

Assembly Instructions:

Step 1. Unpack and place all parts on a surface or floor.

Step 2. Secure the mounting plate (A) to the wall using plastic screw anchors and grub screws (a) to ensure stability.



Step 3. Use screw (b) to attach the body (B) to the mounting plate (A).

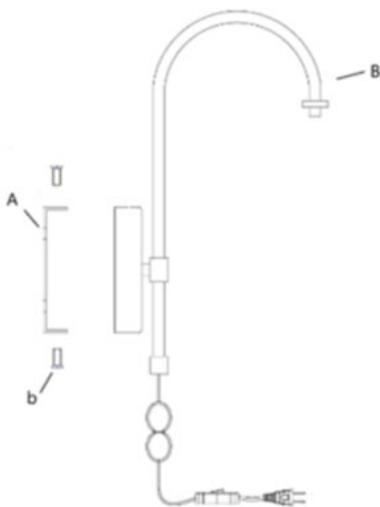

Step 4. Screw the rattan shade and socket (C) into the body (B).

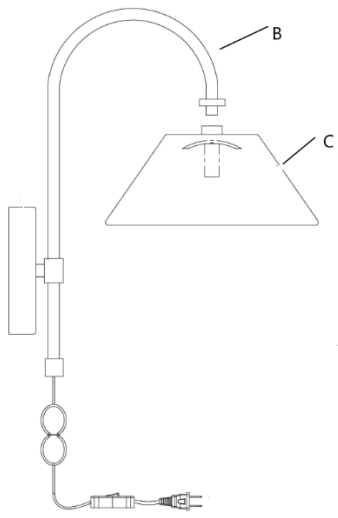

Step 5. Insert the light bulb (not included) and then attach the shade (D) by screwing it in place.

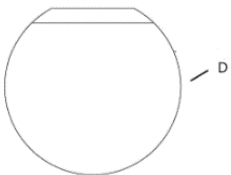
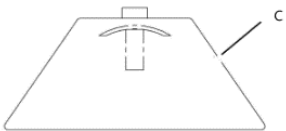

Step 6. Assembly is completed.