

## Customer Service Center :

If you have questions or need help, please contact us ! Online customer service is your fastest option, followed by email support.

Please visit our support site to get started and resolve your issue.

### Chat Support

[www.dvpets.com](http://www.dvpets.com) (Sitemap)

### Email Support

[support@dvpets.email](mailto:support@dvpets.email)

## Follow Us :

Tags: #DVPETS

Photo Sharing: @DVPETS

TIKTOK: @DVPETS

YOUTUBE: @DVPETS

INS: @DVPETS

DVPETS Official Website: <https://www.dvpets.com/>



# Automatic Cat Litter Box BP24Z01



—  
FOR CATS

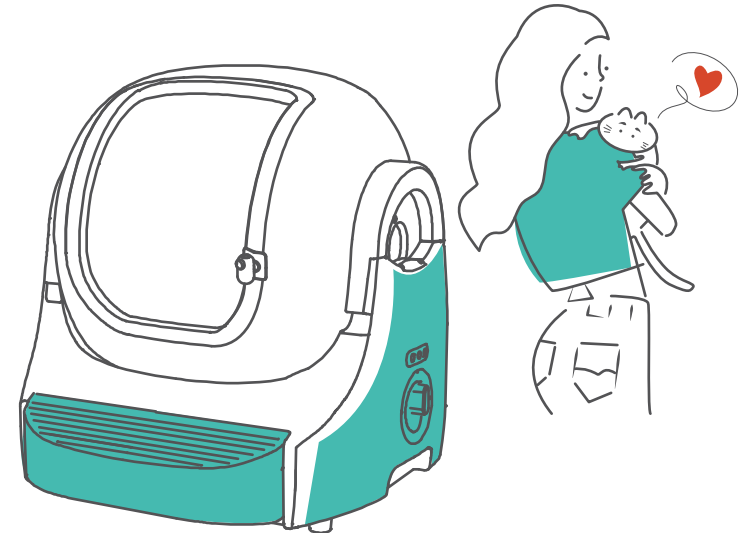

# CONTENT



01	Product Structure	02
02	Product Packaging List	03
03	To The User	04
04	Product Features	05
05	Ready To Power Up	06
06	Accessory Installation Instructions	09
07	Anti-stick pad removal and installation	11
08	How To Adapt The Cat	13
09	Add Cat Litter	15
10	APP Download and Connection	17
11	Introduction To Manual Panel	19
12	Change Cat Litter & Clean Waste Drawer	23
13	Protective Measure	24
14	Maintenance And Cleaning	25
15	Safety Precautions	30
16	FAQ	31
17	Certification/parameters (Technical Specifications)	34
18	Trouble Shooting	35
19	After Sale Instructions	36

## 01 Product Structure

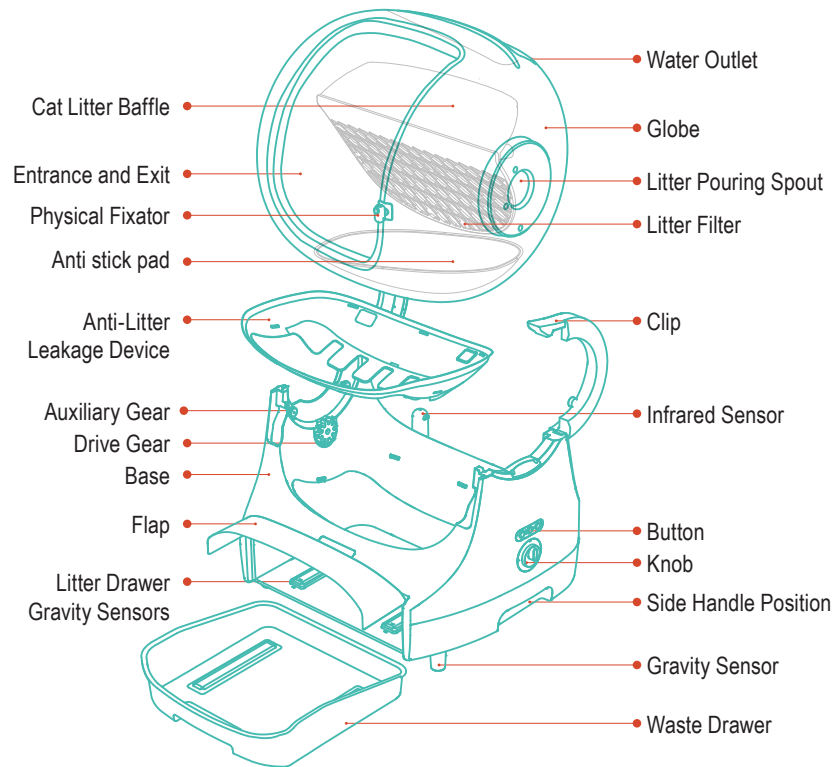

## 02 Product Packaging List

Unlock the Cat litter box for cats in the box and the accessories in the waste drawer. Open the package to get the cat litter mat, pull open the door of the litter box, take out the accessories and freebie bag, which contains the power adapter, manual and other accessories.

① (Give away)

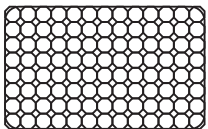

Litter filter

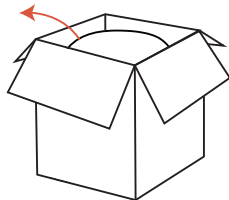

②



Adapter(anti-bite)

③



Heighten feet

④



Garbage bag(1 roll)

⑤



Instructions

⑥



Cable ties

⑦



Mute feet

⑧ (Give away)



Cat litter scoop



### ⚠ Attention:

2.1.1 This product uses (70\*38cm, the bag opening is 70cm) garbage bag, you can purchase the garbage bag of this specification through the seller or the DVPETS website. (<https://www.dvpets.com/>)

2.1.2 A Litter Filter has been assembled in the barrel, if you need other sizes, please contact customer service to purchase it. ([service@dvpets.email](mailto:service@dvpets.email))

## 03 To The User

Thank you for choosing DVPETS. For proper and safe use of this product, please read this instruction manual carefully and thoroughly before use and keep it in a safe place for future reference. Failure to do so may result in injury to your pet or damage to the product. Please note that the DVPETS brand is not responsible for any malfunctions or damages caused by improper use, modification by anyone other than our personnel, installation or maintenance. DVPETS reserves the right to interpret and modify this manual.

## 04 Product Features

### 1 Multiple safety guarantees

Entrance/exit physical fixator + multi-modal micro-weight Sensing technology to ensure the safety of cat use.

### 2 Multiple odor barrier design

Anti-litter leakage device, effectively isolate odors and keep the air fresh.

### 3 Intelligent multi-cat recognition

Micro-weight weighing recognizes multi-cat data at a glance.

### 4 Independent weighing module For waste drawer

It is the first time in the industry to realize the accurate weighing of the cat's defecation volume, which makes the data more accurate and the cat's care more considerate.

### 5 Multi-country patent escort

It has applied for patents in china, the united states, the european union and other countries around the world.

### 6 Large compartment space

Extra-large bin space based on real-world data + 11l waste drawer capacity for long-lasting savings and worry-free big cats.

### 7 Easy to remove and wash

The globe, anti-litter leakage device and waste drawer can be disassembled and washed for cleaner cleaning.

### 8 Do not disturb mode

Do not disturb periods can be set on demand to ensure that the pet owner's rest is not disturbed.

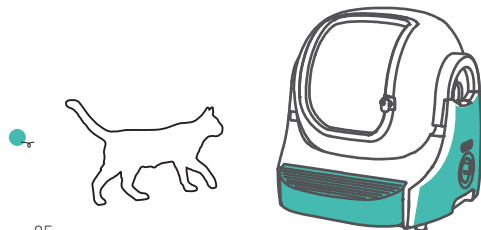

## 05 Ready To Power Up

### 1. Unpacking and preparation before use:

Open the box from the top, remove the top accessories and cardboard, lift the clear bag containing the machine out of the box, remove the clear bag and simply place the product horizontally on the floor. Note that you need to remove the accessories from the waste drawer before use, make sure that the waste drawer has been pre-sleeved with a garbage bag.

### 2. Product placement:

(1) Level the floor Placement Steps:

After removing the machine, place it on the ground and make sure that all four bottom feet of the product are in contact with the ground.



Mute feet

(2) Carpet placement steps:

Note: Before placing the carpet, it is necessary to use the heightening feet to increase the height of the litter box.

Take out the 4 heightening feet in the accessory and put them on the bottom corners of the machine to make sure the feet are covered.



Heighten feet

Then put the new mute feet under the heightening feet to ensure that the machine can be placed smoothly and that all four feet of the machine are in contact with the ground.

#### ▲ Attention:

5.2.1 Ensure that the 4 feet of the litter box are placed smoothly on the floor with no foreign objects topping the bottom to avoid uneven placement resulting in uneven contact of the 4 gravity sensors and affecting weighing accuracy.

5.2.2 If all 4 bottom feet fall on the carpet, you need to pay attention to whether the bottom center of the product touches the carpet, if it does, it will lead to low weight data.

5.2.3 If the 4 feet fall on different floor tiles, the height difference between adjacent tiles will also affect the accuracy and stability of the weight data.

5.2.4 When the weight data is only about half of the normal level of the cat's body weight, pay attention to whether the cat only partially enters the litter box for a long period of time, resulting in inaccurate data.

## 05 Ready To Power Up

Place on the floor:

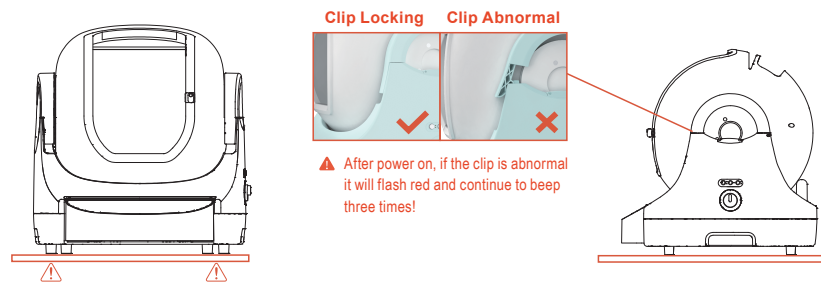

Place on the carpet:

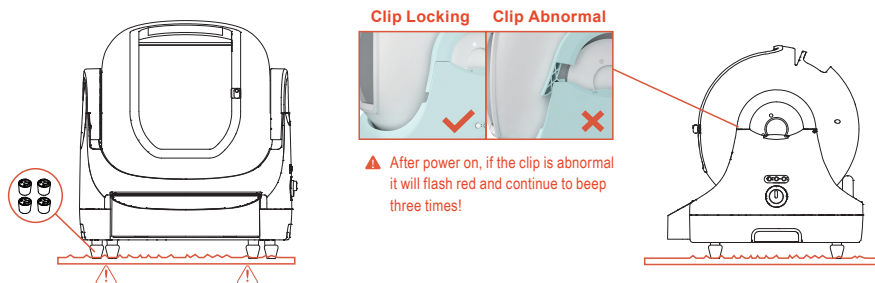

## 05 Ready To Power Up

### 3. Product power supply:

Use the power adapter to power the product, wait for the product to self-test, and when you hear a drop, the power-on is complete.

(The power cord can be organized with the supplied cable ties.)

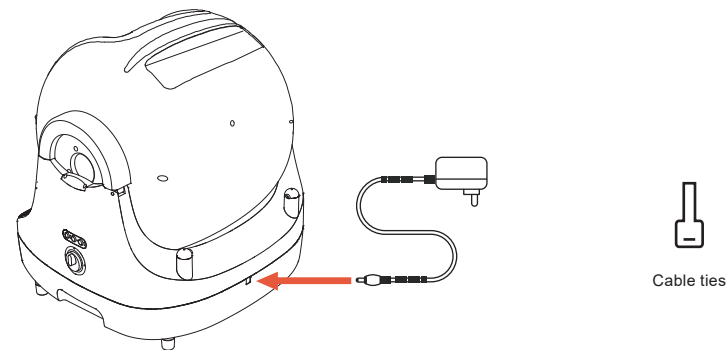

#### ▲ Attention:

5.3.1 Before energizing the product, make sure that the left and right clips of the product are fastened to the globe.

5.3.2 After the product is powered on, do not pick up or move the product at will, moving the product may interfere with the weight calibration in the reset program.

5.3.3 The product adopts the Entrance/Exit physical fixator + multimodal micro-weight sensing technology to ensure the safety of cats.

5.3.4 If the machine does not work properly, you can try to troubleshoot the problem from the trouble shooting (17- Trouble Shooting P35), or you can try to power off and restart, and wait patiently for the product to complete the self-test, and then it will enter the default auto-sensing mode.

## 06 Accessory Installation Instructions

### 1. Mute feet, \*Heighten feet:

**Mute feet:** the bottom 4 feet of the machine is affixed with mute feet, mute and protective.

**\*Heighten feet:** due to the machine bottom four feet configured with gravity sensors, in order not to affect the accuracy of the machine needs to be placed on the carpet can be used when the heighten feet set the bottom four feet of the equipment to increase the height of the support, to avoid the impact of the machine outside the recognition of the sensor.

**Installation of heighten feet method:** need to tear off the bottom 4 feet of the machine's mute feet, and then take out the heighten feet, according to the card position graphic set, counterclockwise rotation and card four feet, and then the new mute feet under the heighten feet, to ensure that the machine can be placed smoothly, and the four feet of the litter box are in contact with the ground.

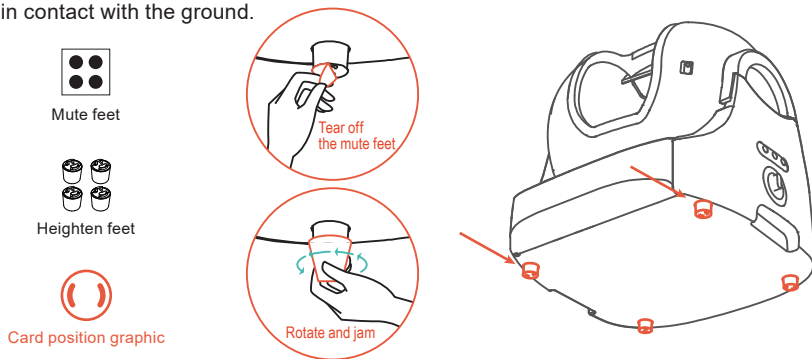

\*Non-essential accessories, only for some of the family carpet pile is too high to affect the normal operation of the machine need to install the situation.

## 06 Accessory Installation Instructions

### 2. Cat litter mat:

Comes with the machine with 1 cat litter mat, one side can be "open mouth", double layer design.

- Size: 600\*450 MM / 23.6\*17.7 IN Color: Gray

- Material: EVA material (high stability, soft shock absorption, wear-resistant and scratch-resistant, environmental protection without odor, washable)

- Usage: Upper large aperture to collect cat litter, the lower layer to store the cat litter, three sides of the locking edge does not leak the cat litter, one side can easily pour the cat litter back to the litter box.

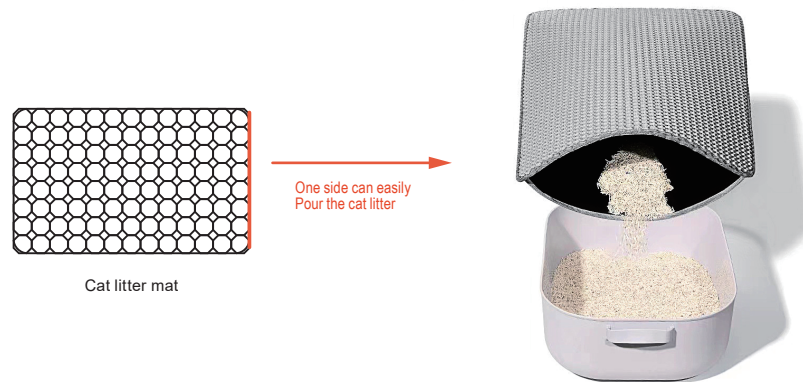

## 07 Anti-stick pad removal and installation

"The globe is equipped with an anti-stick pad, which can be disassembled and cleaned as needed. Removal and installation method:

1. Remove the globe compartment, turn to the bottom of the ball compartment, there are 4 screw holes
2. Remove the screws, the anti-stick pad can be removed from the inside."

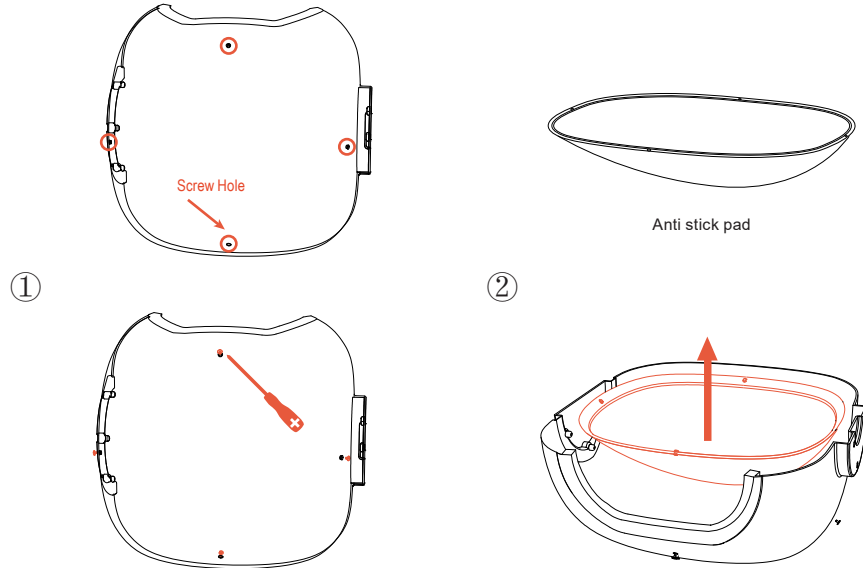

## 07 Anti stick Pad Removal and installation

3. During installation, align the holes of the anti-stick pad with the screw holes and tighten the screws from the bottom. Make sure the edges of the anti-stick mat are flush with the globe.

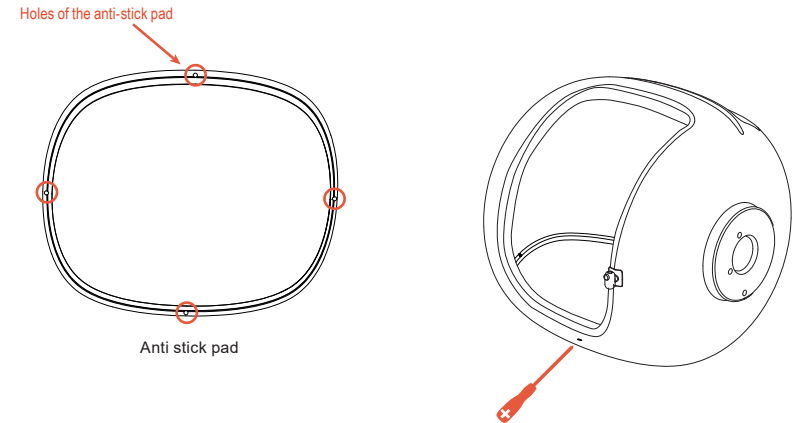

## 08 How To Adapt The Cat

---

### Introduce your cat to the DVPETS Smart Litter Box for Cats:

Most cats adapt quickly to the Cat Smart Litter Box. If your kitten is giving you a hard time or seems to be afraid of the DVPETS Cat Litter Box, here are some ways to help your cat make the transition.

#### (1) Introduce your cat to the DVPETS Litter Box

Place the DVPETS Cat Litter Box near the old litter box and leave the old litter box in its original location.

#### (2) Add a familiar odor

Remove a scoop of cat litter and cat waste from the old cat toilet. Familiar odors will make cats want to explore. In order to entice your cat to use the “right” cat smart litter box, you can sprinkle some catnip or use your cat's favorite toy to lure him in.

#### (3) Change the litter

Put new litter in the Smart Litter Box, and if it is a different brand than the one you usually use, you should introduce it to your cat slowly: sprinkle some new litter on top of the clumping litter that your cat usually uses. Wait a few days to see if your cat's toilet habits change. Slowly increase the amount of new litter in your cat's Smart Litter Box until you are no longer using the old litter. Continue to observe changes in your cat's toileting behavior.

## 08 How To Adapt The Cat

---

#### (4) Do not turn on the Smart Litter Box for the time being

For extremely timid cats, you should leave the Smart Toilet for Cats in the usable state at first without turning on the cleaning function. Avoid scaring your cat with the noise.

#### (5) Turn on Clean

Wait for your cat to use the Smart Litter Box, then turn on Manual Clean. Encourage your cat to be present so they can observe the Smart Litter Box cleaning action and familiarize themselves with the cleaning sound.

#### (6) Stop cleaning the old litter box

We recommend that you stop cleaning the old litter box after your cat has used the Smart Litter Box. Because cats prefer a clean litter box, dirty litter may convince them to try a clean Smart Litter Box.

#### (7) Remove the old litter box

Once your cat has become accustomed to using the Smart Litter Box, you can put it in auto-clean mode and remove the old litter box.

## 09 Add Cat Litter

Litter can be added regularly according to the rate of reduction of clean litter. When the total amount of litter left in the ball bin reaches 10%, please add more litter in time. (Please make sure you have registered the litter type in the APP to check the remaining amount of litter.)

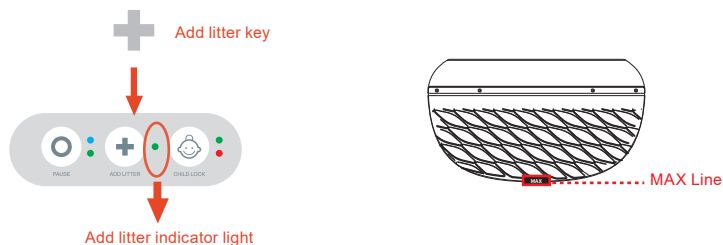

### ▲ Attention:

- 8.1.1 If there is a situation that it does not work properly after adding cat litter, try powering off and restarting.
- 8.1.2 Adding too much cat litter will cause waste, be careful not to exceed the MAX line inside the globe.

## 09 Add Cat Litter

### Operation steps:

1. When adding cat litter, you need to press the “ + ” button, the indicator light will light up, a beep will be heard, and the globe will rotate 45 ° , so that it is convenient to pour cat litter into the globe from the mouth of the bucket;
2. After adding cat litter, rotate the knob in any direction, the cat litter box will be reset, and the cat litter will be smoothed out automatically during the reset process, after smoothing out, check the MAX line under the cat litter filter in the globe to ensure that the smoothed out cat litter has not exceeded the MAX line.

Weight tips for adding cat litter: Tofu litter 2.5kg/5.5lb, Mixed litter 2.8kg/6.1lb (suitable for all kinds of plant mixes up to 2mm in stick diameter), Clay litter / Mineral litter not exceeding 3.5kg/7.7lb (suitable for fine granular soil types), and other types of litter not exceeding a loading of 2.5kg/2.5lb.

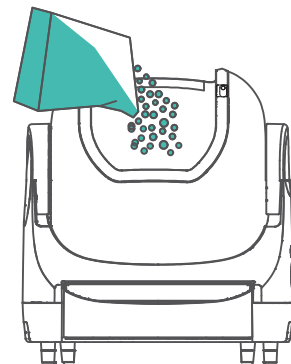

1. Before each litter addition, be sure to press the Add Litter button, rotate the knob in any direction after completion, and then smooth it out to see if the litter is located at the Max line, if it is higher than the Max line, pay attention to reduce the litter.
2. If you do not press the litter button before adding litter, be sure to operate the knob to smooth it out after adding litter.

## 10 APP Download and Connection

### 1. Turn on the power

Please connect the automatic cat litter box to the power supply, and wait for the machine to finish self-test, then you can enter the pending network mode.



### 2. Install APP

Turn on the Bluetooth, use your cell phone to scan and download the APP, and make sure the WIFI network has been deployed at home.



Apple Appstore



Google Play



### 3. Login

Open the APP and follow the instructions to login/register your account.

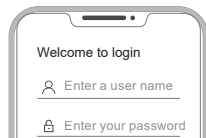

**▲ Attention: If the network allocation fails or timeout is prompted, please check the following possibilities.**

9.3.1 Connect the cell phone to 2.4GHz WiFi, the 5GHz band is not supported for the time being, and hotels, airports, etc. that need special authentication, if the WiFi automatically selects the network, please change to manually selecting 2.4G. (\* Please pay attention to avoiding the special characters in the name of the WiFi, so as to avoid affecting the network allocation )

9.3.2 Whether the cell phone turns on the Bluetooth switch or not. (\* Please put the automatic cat litter box as close as possible to the router)

9.3.3 Whether the product enters the network distribution mode, and whether the WiFi indicator light on the panel is blinking fast.

9.3.4 The router is connected to many wireless devices, resulting in IP address conflict.

(\* If the router fails to connect to the network, please be patient and try again, and check whether the WiFi password is input correctly. If you confirm that the operation is correct for several times but the network allocation fails, please contact the after-sales service for assistance in solving the problem.)

## 10 APP Download and Connection

### 4. Press and hold the “O” key

Press and hold the “O” button on the product panel for 3 seconds, the network indicator light will start flashing, and you will hear 1 drop, the automatic litter box has entered the network waiting.

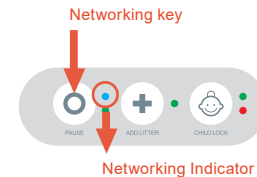

### 5. Add device

Open APP and select Add Device, or Auto Identify; add the device when it is found.

**Tips:** Please make sure the Bluetooth is turned on, if the APP can't find the device, please press and hold the “O” button for 3 seconds as instructed, and retry to add the device.



### 6. Set up the WIFI network

Configure the connected WIFI for the automatic litter box, enter the WIFI password, click next; when the process is completed, the indicator light is always on, then the configuration is successful, you can experience.



## 11 Introduction To Manual Panel

If there are children at home, you can set up to prevent children from operating the automatic litter box:

**open the child lock:** long press the “Child Lock” button for 3 seconds, the green light is always on to add the lock;

**unlock the child lock:** long press the “Child Lock” button for 3 seconds, the green light is off to unlock.

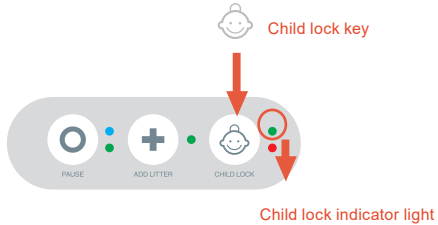

## 11 Introduction To Manual Panel

### 1. Key Description



Keys	Operations	Status	Indicator Light		Beep
○ Pause button	Click	Pause <small>(Automatically resumes operation after 15 minutes of no operation)</small>	Green light	Always on	Beep 1 time
		Running		Light out	
	Long press 3 seconds	Start distribution network	Blue light	Fast flashing	
		Close the distribution network		Light out	
	×	Networking in progress		Slow flashing	×
×	Normal networking	Always on	×		
+ Add Litter button	Click	Turn to 45° to add cat litter	Green light	Always on, End off	Beep 1 time
		Globe reset smoothing <small>(Or turn knob in any direction to reset)</small>	<small>(Smoothing light)</small> Green light	Always on, End off	
	Long press 3 seconds	Turn off the waste drawer full indicator and audible tone			×

\*Before adding new litter, click the '+' button and the globe will rotate 45° with the Entrance and Exit pointing upwards to allow for litter to be added; after adding new litter, rotate the knob in any direction and the automatic litter box will reset, smoothing out the Entrance and Exit to return to a positive angle.

## 11 Introduction To Manual Panel

Key	Operation	Status	Indicator		Tone
 Child lock key	Long press 3 seconds	Add lock	Green light	Always on	Beep 1 time
		Unlock		Light out	

### 2. Knob Description

Knobs	Operation and Status	Indicator Light	Beep
Auto	Daily status, default auto mode	Always on	×
	Timer mode	Slowly flashing	×
	Manual mode	Off	×
 Cleaning key	Turn to Cleaning key will perform cleaning of cat litter, automatically return to Auto.	Always on, End off	Beep 1 time
 Smoothing key	Turn to Smoothing key will execute smoothing cat litter, automatically return to Auto.	Always on, End off	

\* Cat litter box default automatic mode, through the APP can be switched to timed mode or manual mode

## 11 Introduction To Manual Panel

### 3. Other Tip Notes

Source	Status	Indicator Light		Beep
Globe	Not installed (Button is locked in this state)	(Child lock light) Red light	Fast flash	Continuous beep 3 times
	Reset abnormal			
Waste drawer	Not installed/abnormal	(Pause Lamp) Green light	Always on	Beep 3 times
		(Child lock light) Red light	Fast flash	
	Waste drawer will be full (APP shows poop volume up to 100%)	×	×	
Clips	Not closed (Button is locked in this state)	(Child lock light) Red light	Fast flash	Continuous beep 3 times
Foreign object detection	Detection of the presence of a foreign object in the globe			
Machine overload	Globe appears jammed / Litter in globe is too heavy			
Infrared sensor Detection	Cat detected	(Pause Lamp) Green light	Always on	×
Cat Entry	Cat detected	(Pause Lamp) Green light	Always on	×

\* The automatic litter box is not functioning properly, check(17- Trouble Shooting P35) to troubleshoot and solve the problem.

## 12 Change Cat Litter & Clean Waste Drawer

Clearance is the emptying of all cat litter in the globe. You can change to new litter periodically depending on the condition of the litter usage. After a long period of use, the cat litter will become damp, stained with odor and harbor bacteria, so it is recommended to change it every once in a while.

### 1. Clearance:

(1) Prepare an empty litter bag. You can use the free litter scoop to clean up the litter in the globe, and the remaining small amount of litter can be poured out through the litter pouring spout.

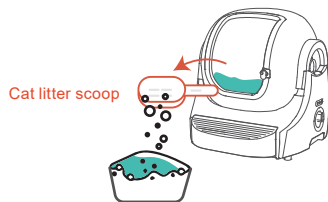

(2) After the emptying is completed, click the key “+” to add cat litter, the indicator light will light up, a beep will sound, and the globe will rotate 45° to facilitate dumping cat litter into the globe from the entrance; after the cat litter is added, rotate the knob in any direction, and the cat litter box will be reset and smoothed out, and then check the MAX line at the bottom of the globe's cat litter filter to ensure that the cat litter has not exceeded the MAX line after it is smoothed out.

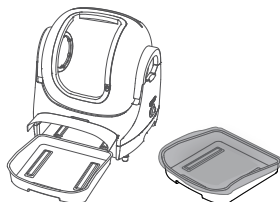

### 2. Waste drawer:

1. Open the flap and pull out the waste drawer to clean and replace the waste bag.
2. Check that the waste bag is properly attached, then place the waste drawer correctly and close the flap.

## 13 Protective Measure

Priority	Protection Function	Indicator Light
Level 1	Infrared sensor protection	During the rotation of the globe, a moving object enters the globe to trigger the infrared sensor protection, the globe stops rotating, the pause light is on, and there is an exception notification from APP. When detecting no object blocking the infrared sensor, it will be resumed automatically after 10 seconds, or manually click the clear button to release it.
Level 2	Gravity sensor protection	During the rotation of the globe, an object larger than 1kg enters into the globe will trigger the gravity sensor protection, the globe stops rotating, the pause light is on, it remains for a long time and APP has an abnormal notification. When the object is detected to leave, it will be resumed automatically after 10 seconds, or manually click the clear button to release it.
Level 3	Physical fixator protection	When all sensors fail and the machine is not under control, the physical fixator will activate protection. At this time, the red light is flashing fast, continuous beeping 3 times and APP has abnormal notification. You can disconnect the power and restart the machine to release this state.

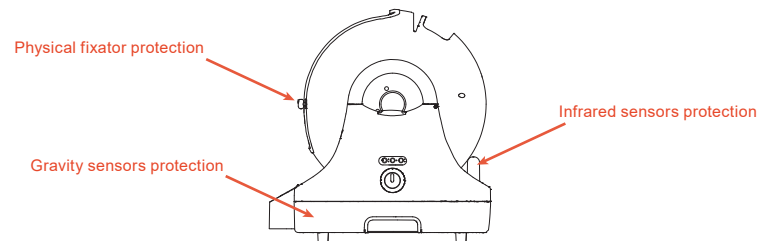

## 14 Maintenance And Cleaning

### 1 . Wiping and maintenance in special circumstances

- Depending on the cleanliness of the automatic litter box, the surface of the unit will be covered with dust after a long period of use and can be wiped clean with a soft gauze.

**Note:**

Wipe with a slightly damp and soft clean cloth, do not use aggressive solvents or disinfectants.

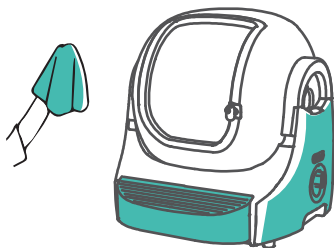

### 2. Monthly dismantling and maintenance

- After a period of use, the machine can be dismantled for cleaning and maintenance at any time according to the use of the machine. When disassembling and cleaning, it must be noted that only the globe, Anti-Litter Leakage Device, waste drawer and other components that do not contain electronic components can be washed directly in water, while the base cannot be washed in water. When dismantling and cleaning, it is recommended to use water, or add a little mild detergent, please do not use corrosive solvents or disinfectant. After cleaning, please dry the machine before installing it in the base to prevent water drops from sliding down to the base and causing damage to the machine.

**Note:**

Wash with clean water and wipe dry with a soft dry cloth after cleaning.

## 14 Maintenance And Cleaning

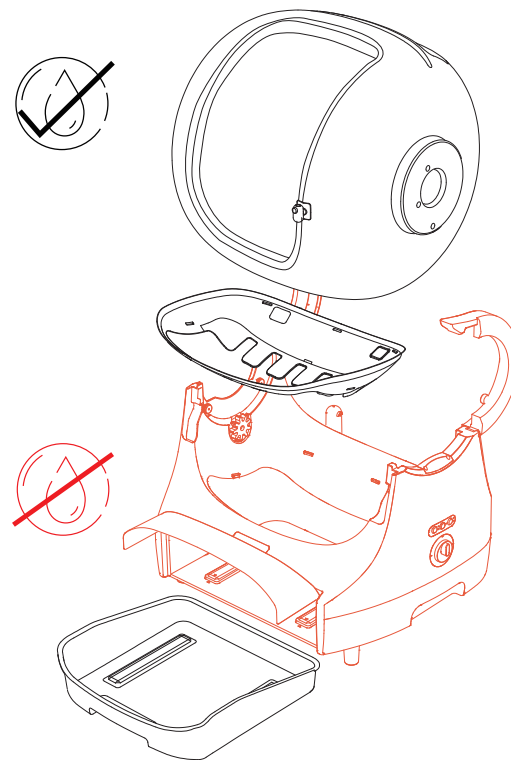

- Red: Non-washable

- Black: Washable

- All parts except the base can be rinsed ( shown ), air dry or wipe dry the product after rinsing.

- Regular cleaning of the automatic litter box can effectively prevent pet diseases and insects; For multi-cat households, it is recommended to increase the frequency of cleaning to ensure the health of pets.

## 14 Maintenance And Cleaning

### 3. Removing the globe and waste drawer

Before disassembling the globe, please disconnect the power to the machine and clean the inner cat litter and waste for subsequent washing with water.

#### ▲ Attention:

13.3.1 If you do not power off the machine when disassembling the globe, the machine will report an abnormal signal of the globe's position to the app and the child lock indicator light will flash red and continue to beep for 3 times. After putting back the globe and adding cat litter, the product can be used normally. Or power off and restart the product directly, it can be restored to normal use.

#### Operating procedure:

- Open the left and right clips;
- Take out the globe (if there is any residual cat litter, please pour out the cat litter first before cleaning);
- Take out the waste drawer, take out the litter and dispose of it;
- Take out the anti-litter leakage device;

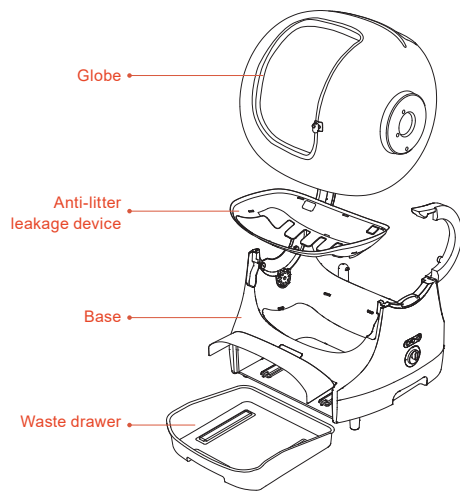

\*If the anti-litter leakage protection is aging, it can be purchased through the DVPETS website (<https://www.dvpets.com/>).

## 14 Maintenance And Cleaning

### 4. Cleaning of globe, waste drawer, anti-litter leakage device

- They can be washed directly with water or warm soapy water, and dried after washing.
- When washing and drying globe, you can use the Water Outlet to leak water internally downwards to speed up internal drying.

"Note:If necessary, the litter filter and anti-stick mat can be removed for deeper cleaning. The removal method for the litter filter can be found in (06 - Attachment Installation Instructions, P9), and the removal method for the anti-stick pad can be found in (07 - Anti-stick Pad Removal and Installation, P11)."

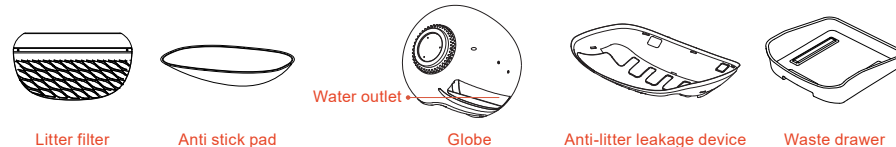

### 5. Cleaning the base

- The base contains electronic components and transmission mechanism, which cannot be washed directly with water, but should be wiped clean with soft gauze.



### 6. Temporary cat litter box

- The waste drawer can be used as a temporary cat toilet while the main unit and other components are drying.

## 14 Maintenance And Cleaning

### 7. Re-installation

- Wait for the machine to dry completely, you can install and start using. Turn on the power, wait for the product reset to complete, add cat litter can enter the default automatic sensor cleaning mode, waiting for the cat's visit.

### Operation steps:

- After opening the left and right side clips, put in the Anti-Litter Leakage Device first;

- Then put in the globe and close the clips (check if the clips on both sides are tightly seated);

- Install the trash bag in the waste drawer and return the waste drawer to the base;

- Turn on the power;

- After confirming that the equipment starts normally, pour in the cat litter and turn it on.

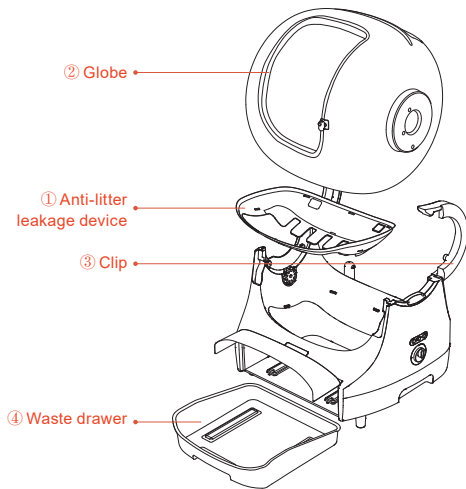

## 15 Maintenance And Cleaning

- ① Please install and use the equipment strictly according to the instruction manual.
- ② **Equipment Placement Requirements:** Please check whether the 4 feet are placed on the horizontal hard ground, do not lean on objects or touch the wall to avoid affecting the weighing.
- ③ **Requirements for moving the equipment:** **The base of the equipment is installed with a precision load cell, do not drag the equipment, if you need to carry it, please use the side handle.**

Litter selection: DVPETS automatic cat litter box is compatible with all kinds of clumping cat litter, such as clay cat litter, tofu cat litter, mixed cat litter, bentonite cat litter, etc. (except for crystal cat litter), pay attention to set the type of cat litter in the APP, to avoid the problem of unclean cleaning or waste.

- ⑤ **Please do not open the two side clips and the waste drawer to disassemble the globe during the normal operation of the device to avoid potential safety hazards.**
- ⑥ Please use the original power adapter, otherwise it will damage the device or cause safety hazards.
- ⑦ The main unit is not allowed to be washed or sprayed with liquid, and can be wiped with a damp paper towel; the globe, waste drawer and Anti-Litter Leakage Device can be washed.
- ⑧ It is strictly prohibited to use the automatic mode for kittens and pregnant cats under 6 months of age or weighing less than 3 lbs / 1.5kg.
- ⑨ Please use the product in an indoor environment and avoid using it in a high temperature and high humidity environment.
- ⑩ Do not immerse or soak the base of this product in water. If it is accidentally wet during the cleaning process, please dry it in time to avoid damaging the device.
- ⑪ Please carry out maintenance under the guidance of professional personnel to avoid various accidental injuries.
- ⑫ In order to provide a better experience, we will regularly upgrade and optimize the equipment, the physical equipment or related functions may differ from this manual, if you have any questions, please contact customer service.
- ⑬ If you have any problems with the use of the product, please contact customer service (please refer to the last page for contact information).

## 16 FAQ

---

### Q: Does the DVPETS litter box require special litter and waste bags?

A: The DVPETS Automatic Litter Box is compatible with any clumping cat litter. We recommend high quality clumping cat litter such as tofu litter and clay litter. With poor quality clumping cat litter, cat feces may not pass through the litter filter efficiently.

### Q: Can the DVPETS litter box clean soft / watery poop?

A: The DVPETS Automatic Litter Box will clean it, and the automatic cleaning wait time can be set to a longer time via the APP until the litter clumps.

### Q: Can the DVPETS Litter Box distinguish between cats in a multi-cat household?

A: Yes, the gravity sensor in the DVPETS Automatic Litter Box can differentiate between cats based on weight. If your cats are very close in weight, the device may not be able to differentiate.

## 16 FAQ

---

### Q: Is there a weight limit on the DVPETS Automatic Litter Box? How many cats can use it?

A: The DVPETS Automatic Litter Box is ideal for cats that are over 6 months old, weigh over 3 lbs / 1.5 kg. There is no fixed number of cats. We recommend one litter box for every 2-3 cats. We do not recommend that kittens or cats weighing less than 3 lbs/1.5 kg use the DVPETS litter box in automatic cleaning mode. Their light weight and small size may not activate the DVPETS Litter Box. Until weighed sufficiently, we recommend that you use it in manual cleaning mode to ensure your kitten's safety and relieve you of the burden of scooping.

For manual cleaning mode, turn off the auto-cleaning feature of the DVPETS Automatic Litter Box on the APP. When you see that your kitten has used it, wait a few moments until the feces clumps, then click the CLEAN button on the APP or rotate the CLEAN icon on the control panel 1 time. The DVPETS Automatic Litter Box will perform 1 cleaning cycle. Continue this supervised manual cleaning mode until all of your kittens have gained enough weight to be detected by the DVPETS Litter Box Gravity Sensor.

In this way, your kittens can safely become accustomed to the DVPETS Cat Smart Litter Box at a very young age, allowing you to get out of the routine of scooping your cat's poop before it's too late!

**Note:** Turn off the auto-clean function via the APP and use only the manual clean function until you are sure that all your cats weigh enough to activate the DVPETS Automatic Litter Box.

## 16 FAQ

### · APP Use

Download APP:DVPETS from APP Store or Android APP Market, enter the APP homepage, add the corresponding device, and bind the device according to the prompts. For details, please refer to (09- APP Download and Connection P17).



Apple Appstore



Google Play

### · Installation and Use

DVPETS Video on Using the Automatic Litter Box



Scan code to watch installation and use video

### · Care and Cleaning

DVPETS Automatic Litter Box Cleaning Video



Scan the code to watch cleaning our automatic litter box

## 17 Certification/parameters (Technical Specifications)

- Product Name: Automatic Cat Litter Box
- Product Model: BP24Z01
- Product Size: 568\*578\*596 MM / 22.3\*22.7\*23.4 IN
- Package Size: 575\*610\*625 MM / 22.6\*24\*24.6 IN
- Overall Weight: 9.3kg / 20.5 lb
- Gross Weight: 14.8kg / 32.6 lb
- Main Material: PP PE
- Rated Voltage: 12V  $\overline{\text{---}}$  2A
- Rated Power: 24W
- FCC ID: 2BGKK-QP23Z01
- Scope of application:  
Cats weighing 1.5-15 kg(3.3-33lb) and over 6 months old

**MADE IN CHINA**

## 18 Trouble Shooting

Abnormal Situation	How To Solve
Infrared sensor is stained, machine stops running	Manually disengage, wipe and clean the Infrared Sensor with a dry towel or paper towel to keep it clean, single press the clean button to clean it once
Waste drawer overfilled, 3 beeps	Keep an eye on the waste drawer poop volume and clean it in time
Physical Fixator protection, machine stops running	Power off and restart
Abnormal clips on both sides, machine stops running	Check if the clips are tight, re-clamp and restart the machine
(Other) Machine stops working, abnormalities/faults	Troubleshoot the problems one by one as follows: 1. Waste drawer/globe etc. is abnormal, not placed accurately, need to be re-positioned; 2. There is foreign matter in the machine, need to clean and check; 3. globe jammed / globe inside the cat litter is too heavy, etc. need to be manually cleaned and checked
Weighing data is not accurate (We have excluded the inaccuracy caused by the use environment)	Check if the 4 feet are flat, or power off and restart

Note: If you have any problems with the product, please contact our customer service (please refer to the last page) and provide us with the device code on the APP so that we can find out the cause.



## 19 After Sale Instructions

Thank you for choosing DVPETS, we are committed to providing you with high quality products and ensuring your satisfaction. Please read the following DVPETS Smart Litter Box Warranty Policy:

### - Warranty Coverage:

DVPETS offers a 1 year warranty on all products purchased through the official website. This warranty covers defects in materials and workmanship under normal use for a period of one year from the date of receipt. If during this period a DVPETS product fails due to defects in materials or workmanship, we will repair or replace it at no cost to the customer.

### - Warranty Exclusions:

This warranty does not cover damage caused by misuse, abuse or normal wear and tear, unauthorized product repair or modification, or any incidental or consequential damage.

### - Warranty Claim Procedure:

To make a warranty claim, Customers should contact the DVPETS customer service team (support@dvpets.email) and provide proof of purchase and a description of the problem. For customers within 3 months of the warranty expiration date, we will offer a 20% discount on the purchase of a new product.

### - Limitation of Liability:

As a condition of this Warranty, the parties agree that the remedies provided on this page are the exclusive remedies under this Warranty. All liability for incidental damage is excluded. Purchaser agrees to retain the original proof of purchase to determine the effective date of this warranty. If DVPETS or an authorized dealer replaces a product under warranty, such replacement shall be considered a transaction under the original warranty and shall not extend the original warranty period.

## 19 After Sale Instructions

---

DVPETS is committed to 100% customer satisfaction. If our product does not meet your expectations, you may return it within 30 days of the delivery date.

### - Order Cancellation

DVPETS accepts order cancellations prior to product shipment. If an order is canceled, you will receive a full refund.

We cannot cancel an order if the product has already shipped. If your order has already shipped, we will refund your payment as soon as we receive and inspect your returned merchandise. Refunds will be processed within 10 business days after review.

### - 30 Day Money Back Guarantee

Products may be returned undamaged for any reason within 30 days of receipt for a refund.

- ① Returns must include all accessories and freebies and be repackaged in the original packaging.
- ② DVPETS will bear the shipping cost for product quality problems. For returns not related to product quality, the customer will have to pay for the shipping costs.
- ③ If the product does not meet the above requirements, the return may be refused.

### - Operating Instructions

For product quality issues, Please send an email to [support@dvpets.email](mailto:support@dvpets.email) initiates the return process. Once confirmed, we will provide you with a prepaid return shipping label. Please ensure that all returns are shipped to the return address specified by DVPETS.

## 19 After Sale Instructions

---

### - Refunds (if applicable):

Upon receipt and inspection of your return, we will send you a receipt notice via email. We will also notify you of the approval or denial of your refund. If you are approved, your refund will be processed within 10 business days and a credit will be automatically credited to your original method of payment (e.g., credit card, PayPal, or other payment method) within a certain number of days.

All refunds will be accepted and a confirmation email will be sent for your records.

### - Please note:

If you purchased your DVPETS product from a channel other than our official website, you will need to coordinate your return with that channel in accordance with their return policy.

If you have any questions or need further assistance with your return, please feel free to contact our customer service team. We will be happy to assist you!

**Thank you for choosing DVPETS. We hope you and your pet enjoy our products and have a pleasant shopping experience.**

## FCC Rules

---

This device complies with part 15 of the FCC Rules. Operation is subject to the following two conditions: (1) this device may not cause harmful interference, and (2) this device must accept any interference received, including interference that may cause undesired operation.

Any changes or modifications not expressly approved by the party responsible for compliance could void the user's authority to operate the equipment.

NOTE: This equipment has been tested and found to comply with the limits for a Class B digital device, pursuant to Part 15 of the FCC Rules. These limits are designed to provide reasonable protection against harmful interference in a residential installation. This equipment generates, uses and can radiate radio frequency energy and, if not installed and used in accordance with the instructions, may cause harmful interference to radio communications. However, there is no guarantee that interference will not occur in a particular installation.

If this equipment does cause harmful interference to radio or television reception, which can be determined by turning the equipment off and on, the user is encouraged to try to correct the interference by one or more of the following measures:

- Reorient or relocate the receiving antenna.
- Increase the separation between the equipment and receiver.
- Connect the equipment into an outlet on a circuit different from that to which the receiver is connected.
- Consult the dealer or an experienced radio/TV technician for help.

The device has been evaluated to meet general RF exposure requirement. The device can be used in portable exposure condition without restriction