

User Guide

Overview

Sturdy wooden tables encourage collaborative play and learning.

Skills

- Social Skills
- Emotion Control
- Sharing and Taking Turns

Hercules 24"W Commercial Grade Wooden Square Table - Adjustable Legs 15" - 23"H, Beech

MK-ME088023-GG



Hercules 24"W Commercial Grade Wooden Square Table - Adjustable Legs 15"-23"H, Beech/White

MK-ME088024-GG



Hercules Commercial Grade 33"D Wooden Round Table - Adjustable Legs 15" - 23"H, Beech

MK-ME088021-GG



Hercules Commercial Grade 33"D Wooden Round Table - Adjustable Legs 15" - 23"H, Beech/White

MK-ME088022-GG



Hercules Commercial Grade 47.5"W x 23.5"D Wooden Rectangular Table - Adjustable Legs 15"-23"H, Beech
MK-ME088025-GG



Hercules Commercial Grade 47.5"W x 23.5"D Wooden Rectangular Table - Adjustable Legs 15"-23"H, Beech/White
MK-ME088026-GG



Hercules Commercial Grade 47"W Wooden Trapezoid Table - Adjustable Legs 15"-23"H, Beech
MK-ME088027-GG



Hercules Commercial Grade 47"W Wooden Trapezoid Table - Adjustable Legs 15"-23"H, Beech
MK-ME088027-GG



Hercules Commercial Grade 59"W Wooden Half Circle Table - Adjustable Legs 15"-23"H, Beech
MK-ME088019-GG



Hercules Commercial Grade 59"W Wooden Half Circle Table - Adjustable Legs 15"-23"H, Beech
MK-ME088019-GG





Congratulations!

You just purchased a piece of happiness. At Belnick, we believe you can transform your spaces into the most inspired places with furnishings that are the perfect combination of form, function and style. As original innovators of online furniture retail, we offer the best selection of popular, contemporary styles at cool, comfortable prices. And, with decades of proven shipping and packaging expertise, our Extended Quality Checklist ensures a rewarding, hassle-free experience time and time again. It's just what you need to bring your vision to life.

Thank you & Enjoy!!
your friends at Belnick



LIKE IT!

*Share it on social
& Tell a friend!
#Spaces2Places*



LOVE IT!

*Write an online
product review
where purchased*



NOT SURE?

*Let us help!
Contact our
customer support.*

Have a question, concern or simply need a hand? Your satisfaction is our top priority. Contact us at 866-552-2810 or customerexperience@belnick.com. We're here to help!

Browse Our Branded Collections

There's something for everyone inside our family of brands.



MERRICK | LANE

Emma+Oliver

TAYLOR + LOGAN

BlackArc



Visit www.belnick.com/brands or scan this code to go even faster!

BELNICK

ONE VISION. ENDLESS POSSIBILITIES.



We pride ourselves on providing an excellent customer experience starting right here with your package and instructions. Everything you need should be right where you need it, so you can get to enjoying your new item ASAP. But despite our best efforts, sometimes "slips happen." If you need any support, from replacement parts to recommendations, please reach out to our wonderful customer support team at 866-552-2810 or customerexperience@belnick.com. We're here to help!

EVERY BELNICK PRODUCT



Quality &
Durability Tested



Packaged
with Care



Shipped from
our U.S. Facility

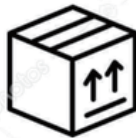

Designed
for Easy
Assembly



Ethically
Sourced

Please visit <https://www.belnick.com/warranty> for complete warranty information.

Read this manual before using this product. Failure to follow the instructions and safety precautions in this manual can result in serious injury or death. Keep this manual in a safe location for future reference.

Multiple Configurations

Modular design lets you re-imagine your space again and again.

Table height can be adjusted between 15 inch up to 23 inch by moving the stopper screw. distance between hole are equal to 1 inch.

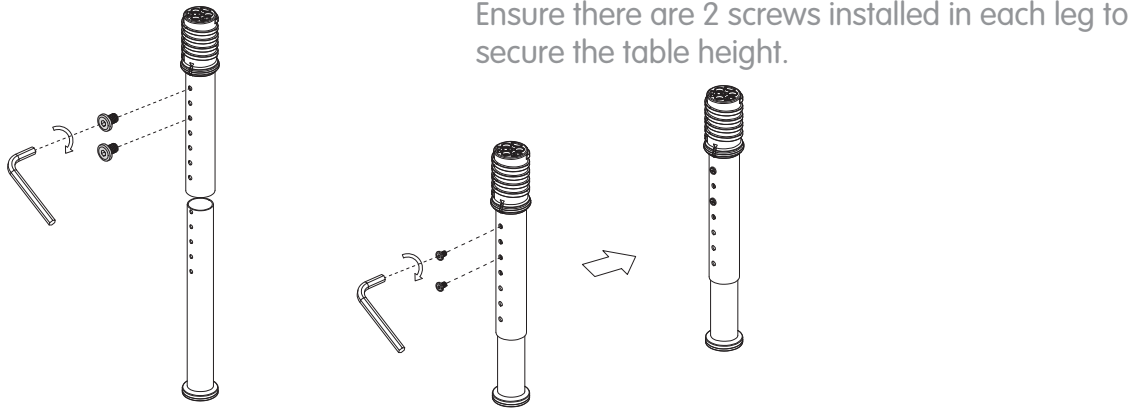

Height configurations :

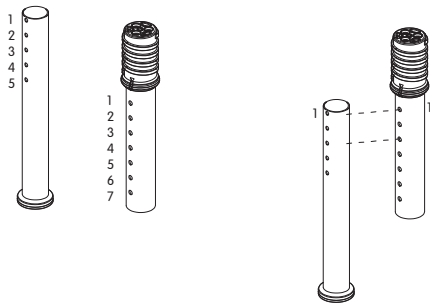

15 inch

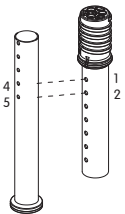

16 inch

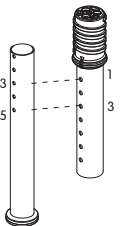

17 inch

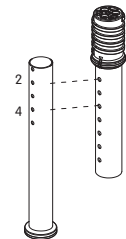

18 inch

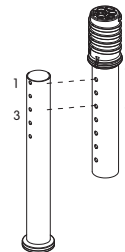

19 inch

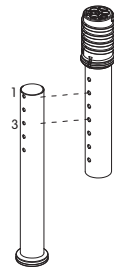

20 inch

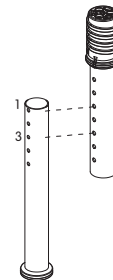

21 inch

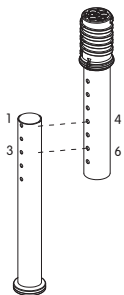

22 inch

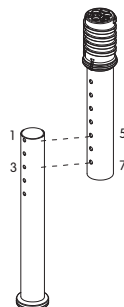

23 inch

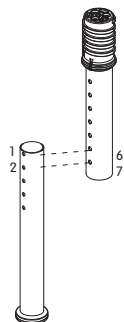

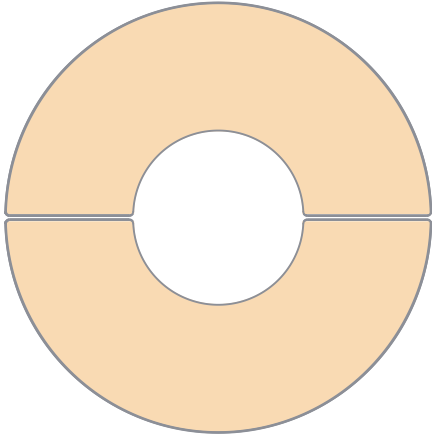

Combine 2 half circle tables into one round table

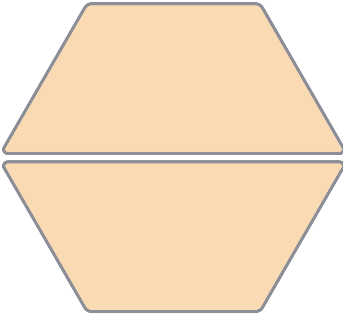

Create hexagon table by arranging 2 trapezoid table

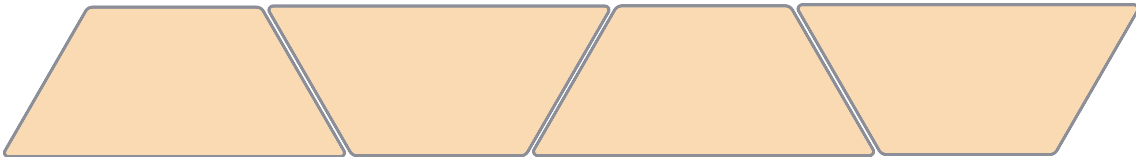
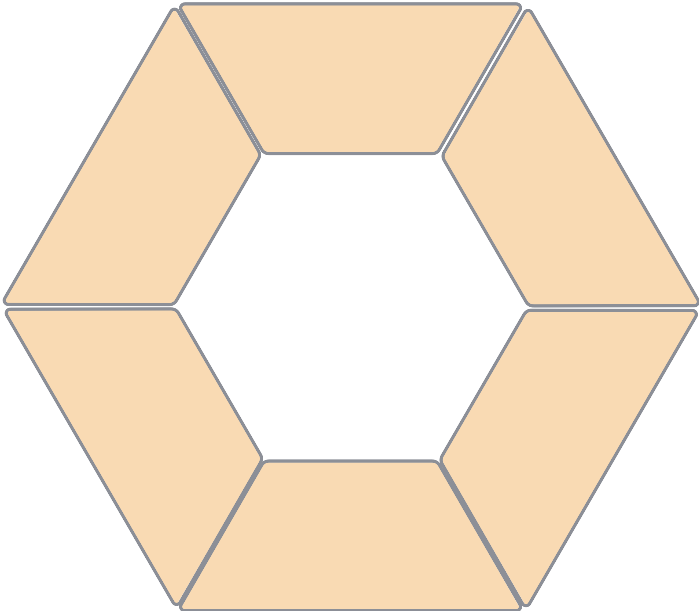
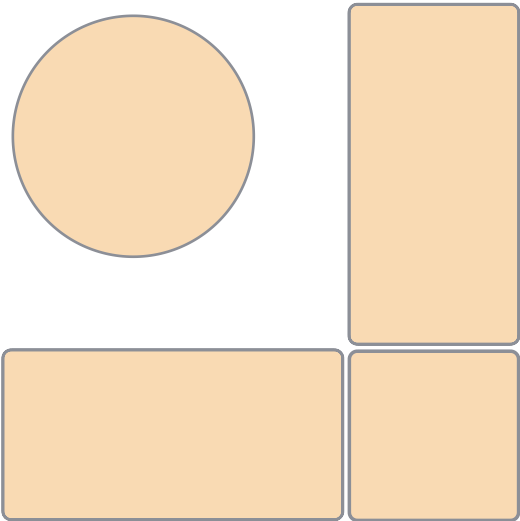

Tables can be arranged and combined based on the available space

We take pride in our play, products and planet. All of our materials are ethically sourced and constructed of premium-grade wood materials including natural European beechwood and engineered wood from New Zealand. Other environmentally-friendly materials, like non-toxic water-based colors, soy ink and recycled packaging, are utilized across our entire collection.

Maintenance

Our products are preservative-free, so nothing is added that may contaminate or pollute. In exchange, a little extra care is needed. Please keep your new items in a low humidity environment. Clean with either a dry erase eraser or a clean sock to remove dry erase markers. For more stubborn marks from drawing or art work, clean with soap and water or a disinfecting wipe.