

Installation Guide

Tools Required

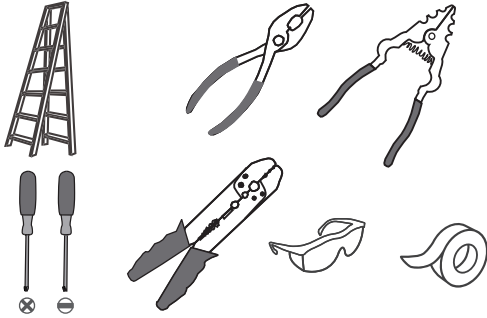

Light Source

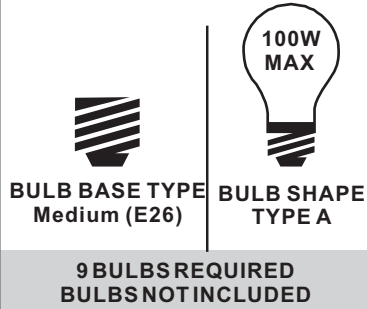

Option 1 (socket up): Fixture Height Adjustable 32" to 129.5"

Warnings and Cautions

Turn off the electricity at the circuit breaker before installation. Consult a licensed electrician if in doubt about installation.

Turn off power to the fixture and allow the bulbs to cool before replacing.

Package Contents

Preparation: Identify and inspect all parts before beginning the installation.

Missing or damaged parts? Contact your original place of purchase.

PARTS BAG

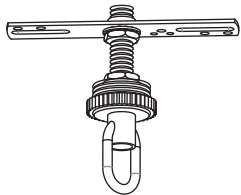

A Crossbar Assembly x 1



B Outlet Box Screw x 2



C Wire Connector x 3

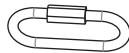

D Quick Link x 2

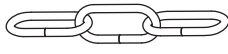

E Fixture Chain x 1

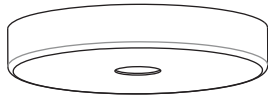

F Ceiling Canopy x 1



G Fixture Loop x 1



H Rod x 2



I Center Column x 1



J Socket Collar x 9



K Shade x 9

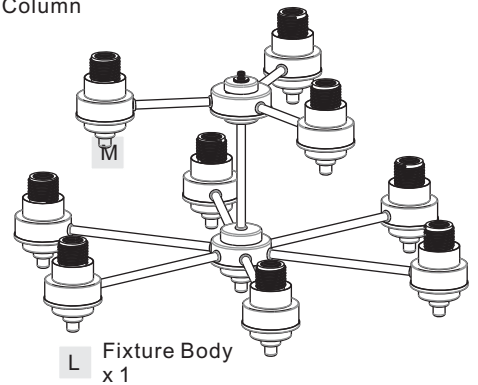

L Fixture Body x 1

Table of Contents

Fixture Loop, Rods & Center Column

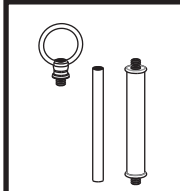

STEP 1

Crossbar Assembly

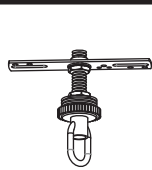

STEP 2

Fixture Chain



STEP 3

Wiring

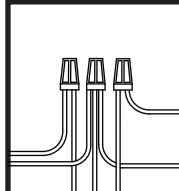

STEP 4

Ceiling Canopy

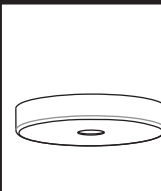

STEP 5

Shade & Bulb

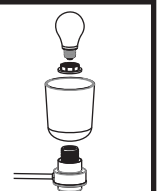

STEP 6

STEP 1

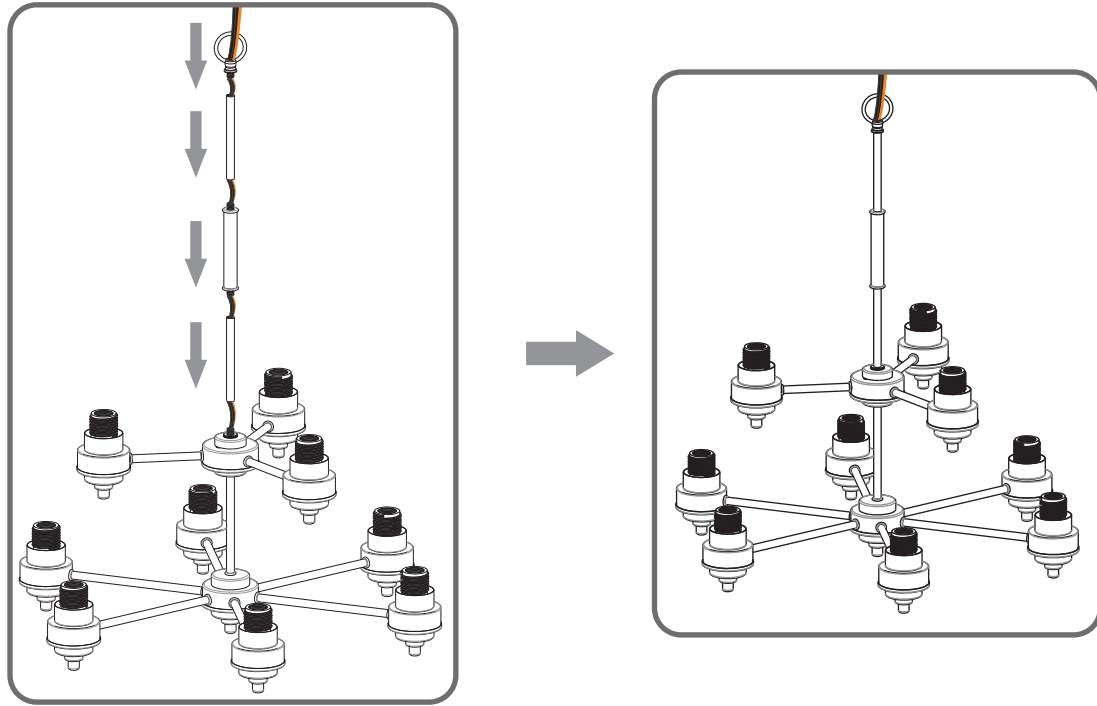

STEP 2

- 1 ----- 2 ----- 3

Step 1
Install crossbar assembly

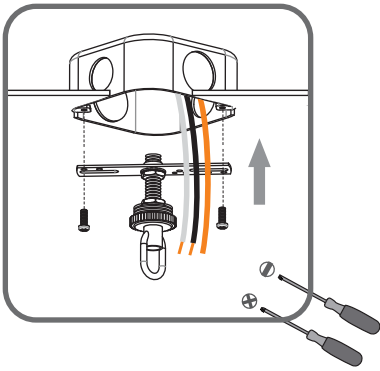

Step 2 - 3
Test fitting ceiling canopy to nipple

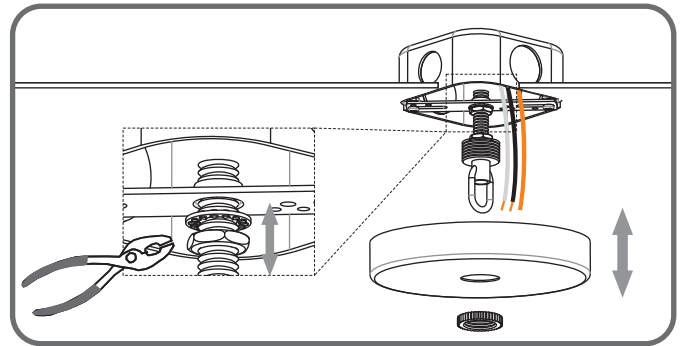
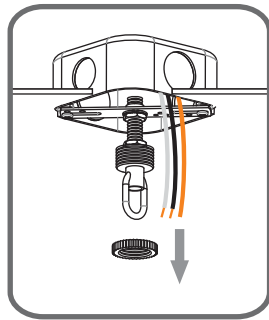

STEP 3

1

Step 1
Adjust fixture chain length

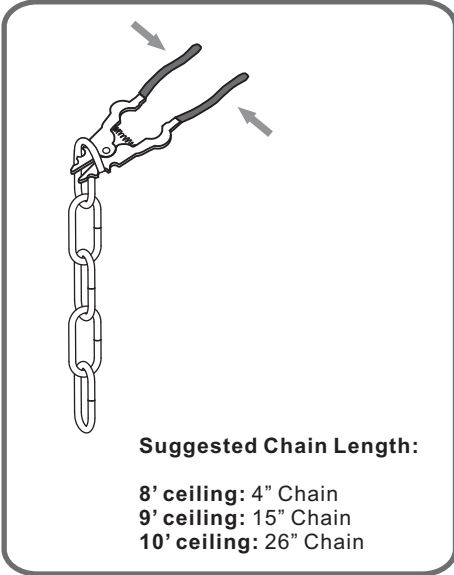

2

Step 2 - 3
Install Fixture Chain

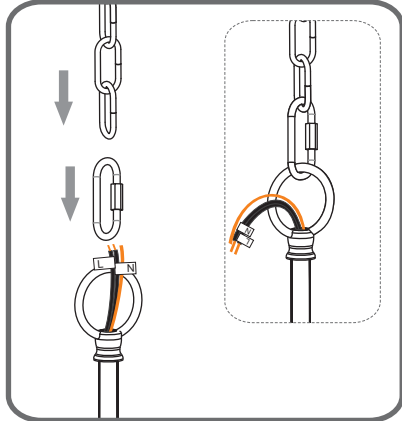

3

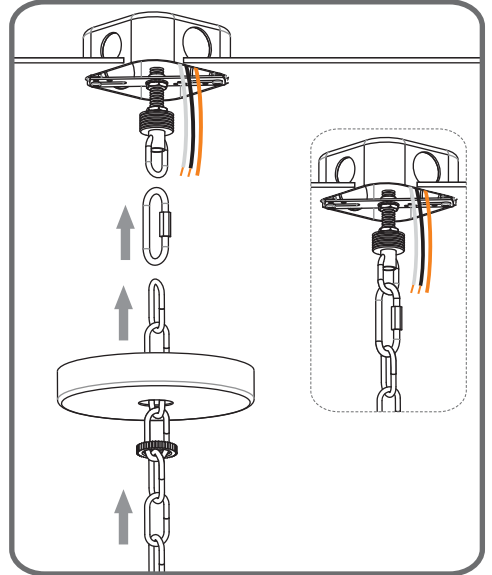

STEP 4

1

Step 1
Feed the fixture wires
through the loop

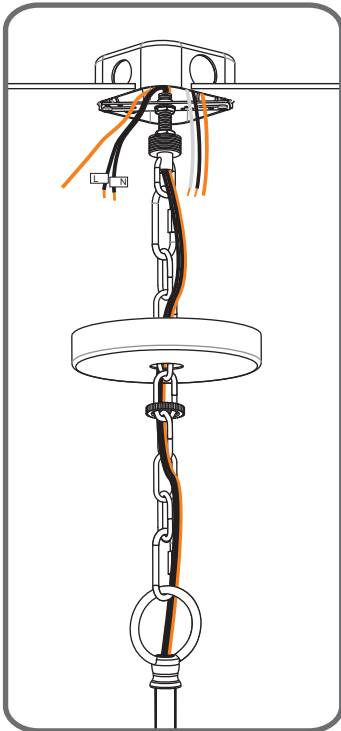

2

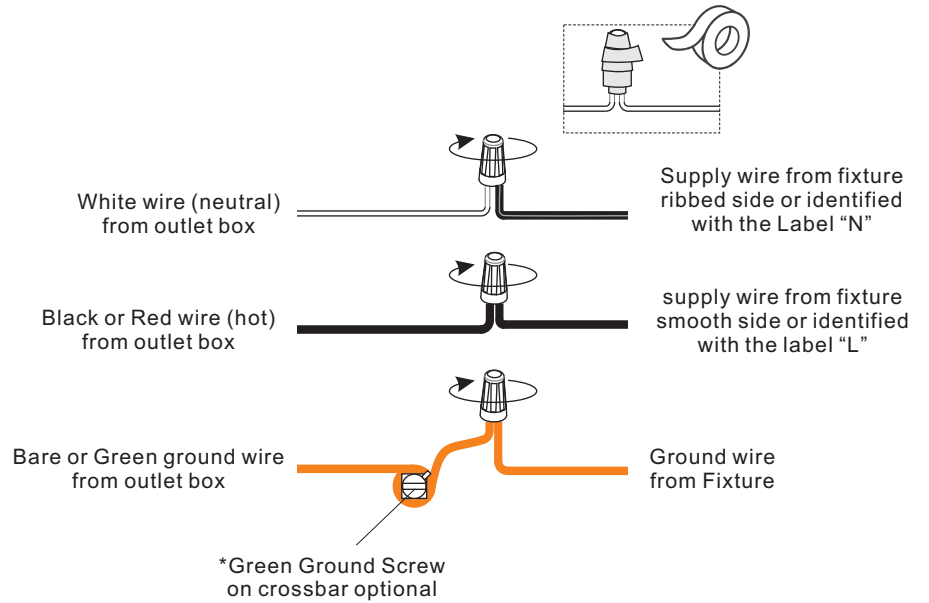

STEP 5

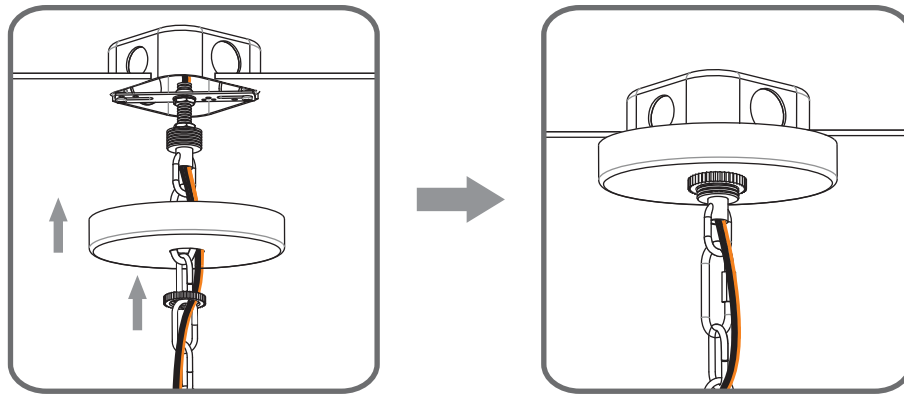

STEP 6

