

ITEM NO.DCQX1398

NOTE:

This brochure contains IMPORTANT safty info. Please read and keep for future reference.

MAINTAINANCE AND WARNING

- 1.Keep furniture away from heat sources.
- 2.Do not clean furniture with harsh cleaner or polishes.Do not use detergents,solvents,abrasives,spray packs or leather cleaner. Use non-color mild soap with warm water to clean spills(Mix 1:10 soap to water).
- 3.Do not place furniture under direct sunlight,material will possibly fade over time.
- 4.Do not use on site dry cleaning machine.Children should not climb or jump on the furniture.
- 5.Do not write on furniture that is not protected by a padded barrier.
- 6.Not for commercial use,only for residential use.



Weight Limitation

250 LBS

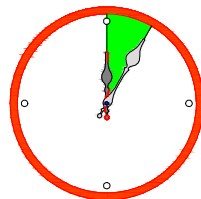

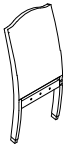

Around **10 min**

PARTS LIST

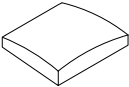
A	X1
	
Back	

B	X1
	
Seat	

C	X2
	
Leg	

D	X1
	
Cloth cover	

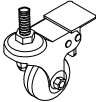
E	X2
	
Rear castor	

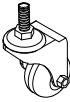
F	X2
	
Front castor	

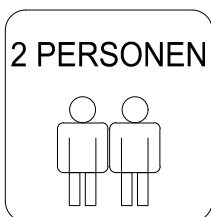



HARDWARE LIST

G	X1
	
Dowel	
Ø10*30	

H	X10
	
Spring washer	
5/16"	

J	X10
	
Flat washer	
5/16"*19	

K	X6
	
Bolt	
5/16"*2"	

L	X4
	
Bolt	
5/16"*3-1/2"	

TOOL LIST

N	X1
	
Allen key	
5mm	

M	X1
	
open wrench	
14mm	

HARDWARE SPARE LIST

G	X1
	
Dowel	
Ø10*30	

H	X2
	
Spring washer	
5/16"	

J	X2
	
Flat washer	
5/16"*19	

K	X1
	
Bolt	
5/16"*2"	

L	X1
	
Bolt	
5/16"*3-1/2"	

ASSEMBLY INSTRUCTIONS

STEP-1

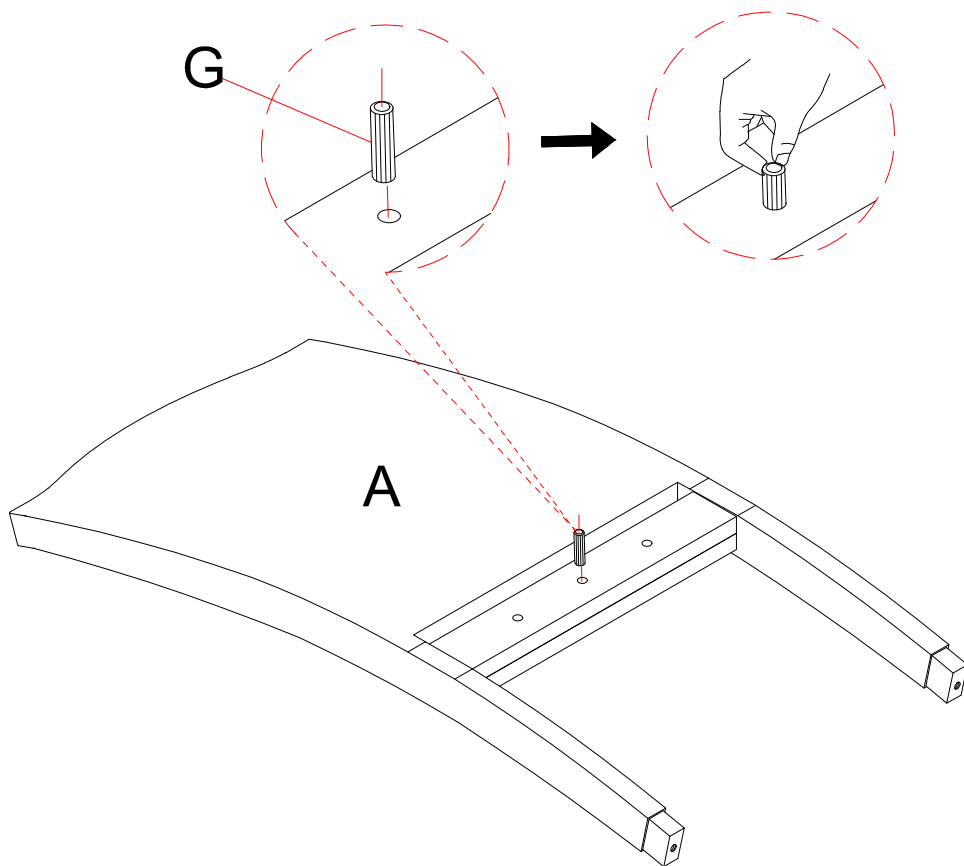

G	X1
	
Dowel	
Ø10*30	

ASSEMBLY INSTRUCTIONS

STEP-2

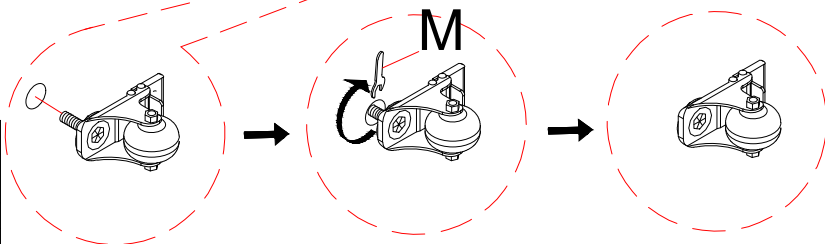
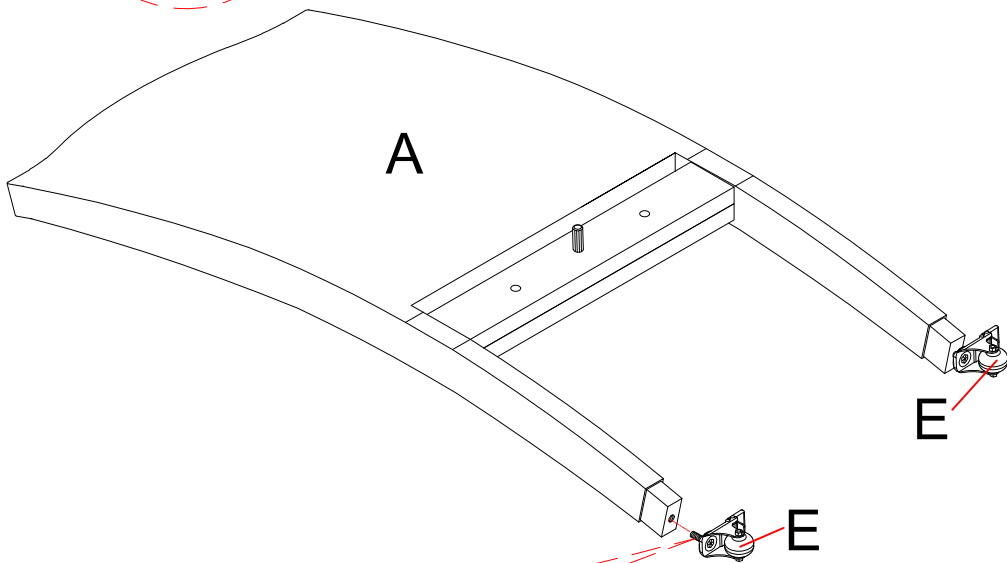
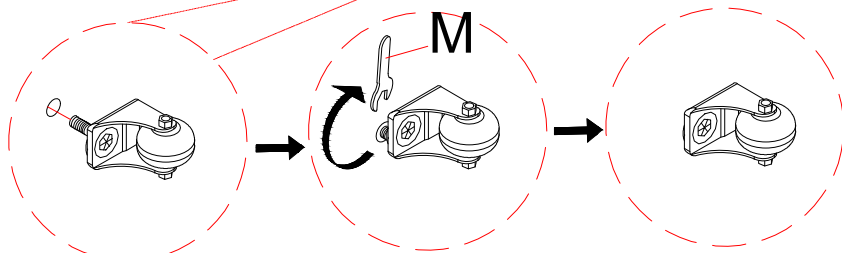
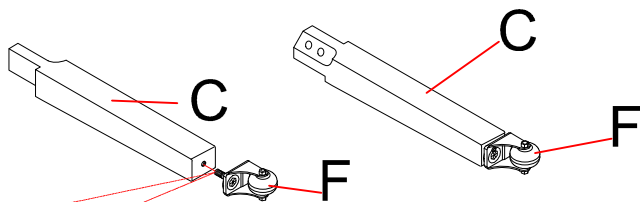

M	X1
open wrench	
14mm	

ASSEMBLY INSTRUCTIONS

STEP-3

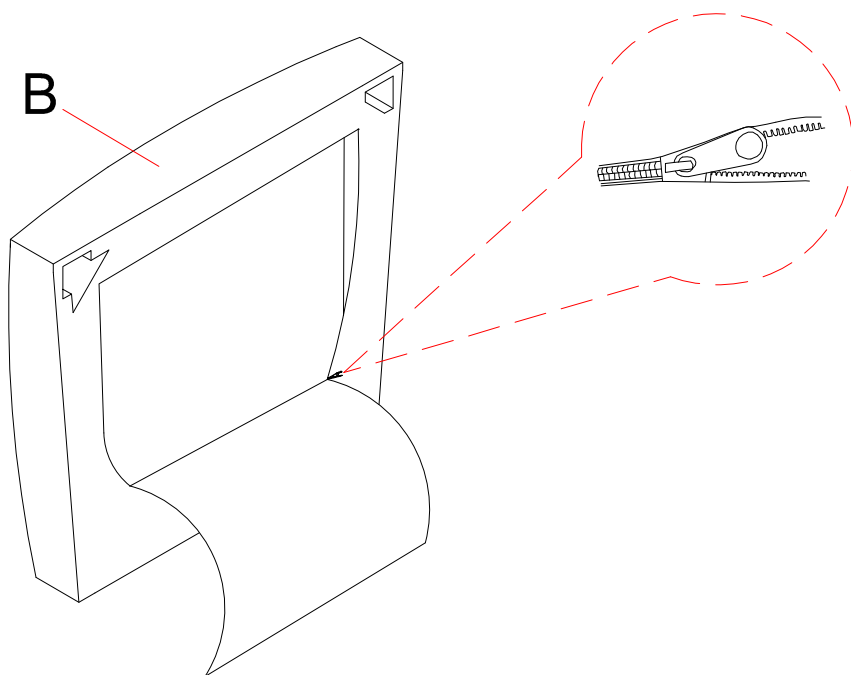

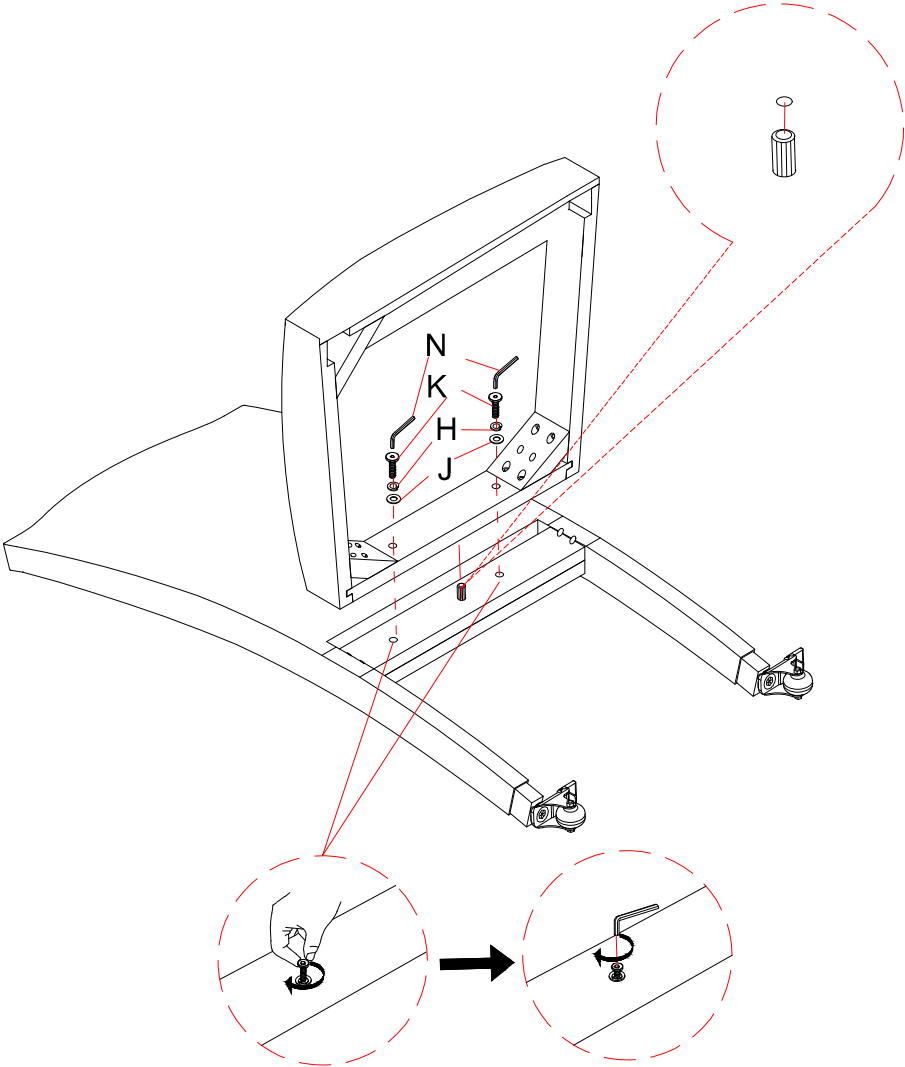

ASSEMBLY INSTRUCTIONS

STEP-4



H	X2
	
Spring washer	
5/16	

J	X2
	
Flat washer	
5/16**19	

K	X2
	
Bolt	
5/16*2"	

N	X1
	
Allen key	
5mm	

ASSEMBLY INSTRUCTIONS

STEP-5

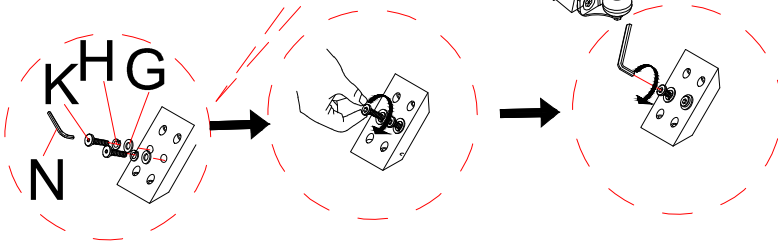
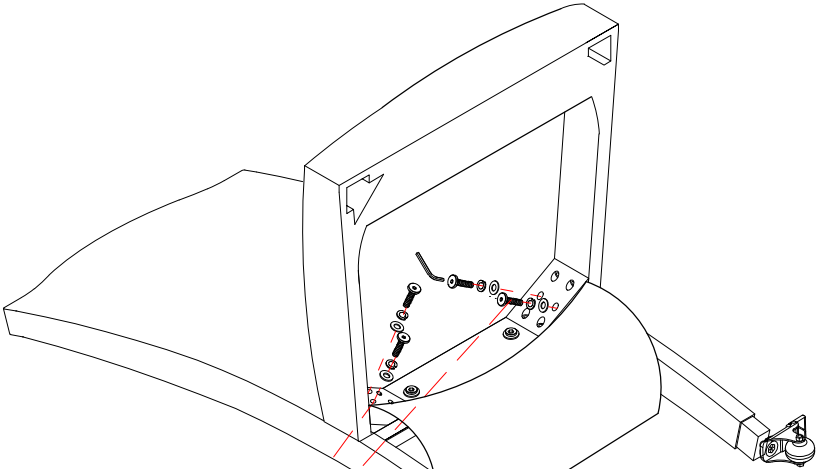

H	X4
	
Spring washer	
5/16	

J	X4
	
Flat washer	
5/16**19	

L	X4
	
Bolt	
5/16*3-1/2	

N	X1
	
Allen key	
5mm	

ASSEMBLY INSTRUCTIONS

STEP-6

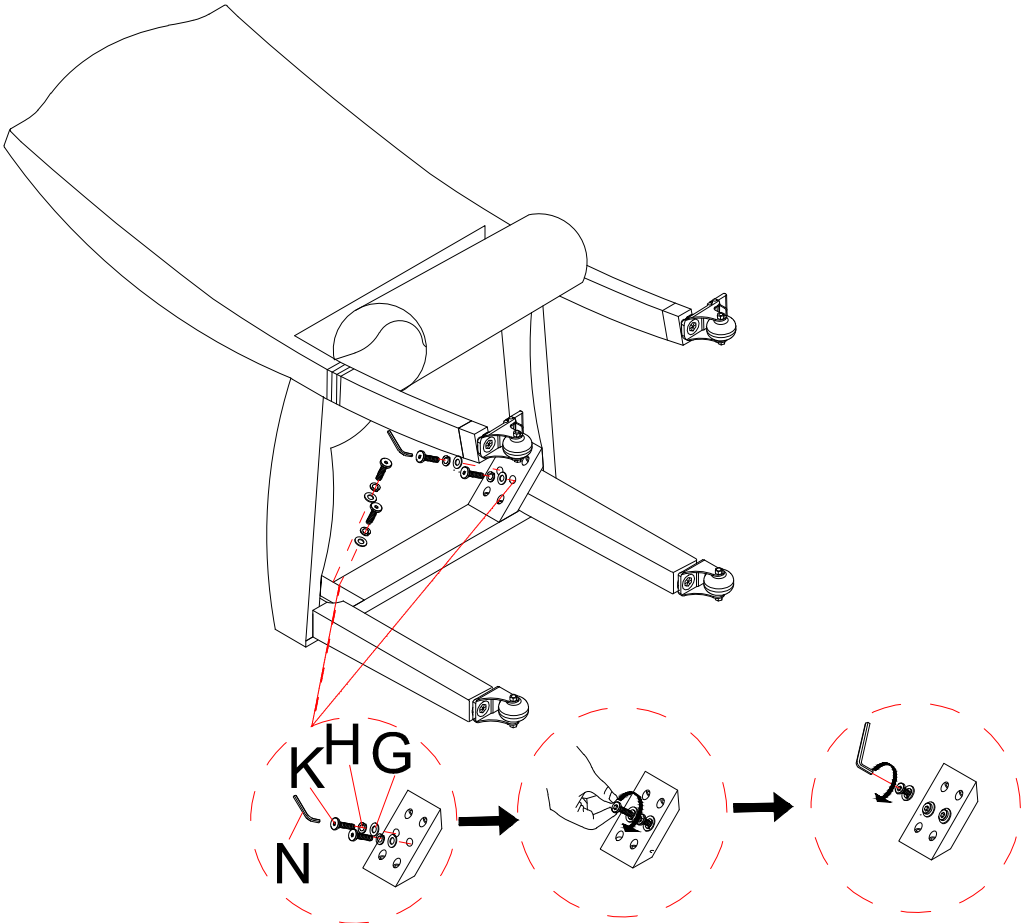

Tighten the bolts by 50%, place the chair on a horizontal surface to ensure it is stable and does not wobble, and then tighten the bolts fully

H	X4
	
Flat washer	
5/16	

J	X4
	
Spring washer	
5/16**19	

K	X4
	
Bolt	
5/16*2"	

N	X1
	
Allen key	
5mm	

ASSEMBLY INSTRUCTIONS

STEP-7

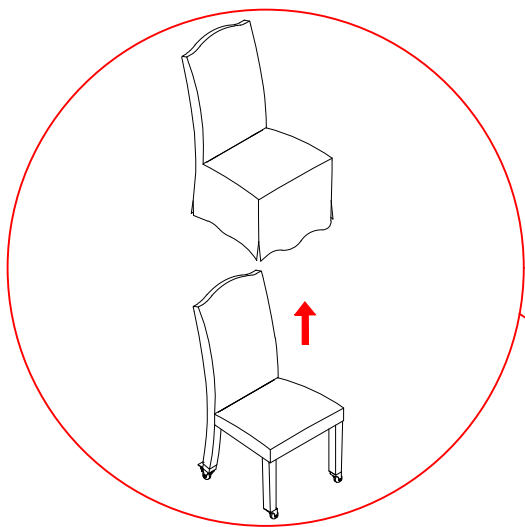

If there are stains on the cover,
you can remove the cover and
wash it in the machine.

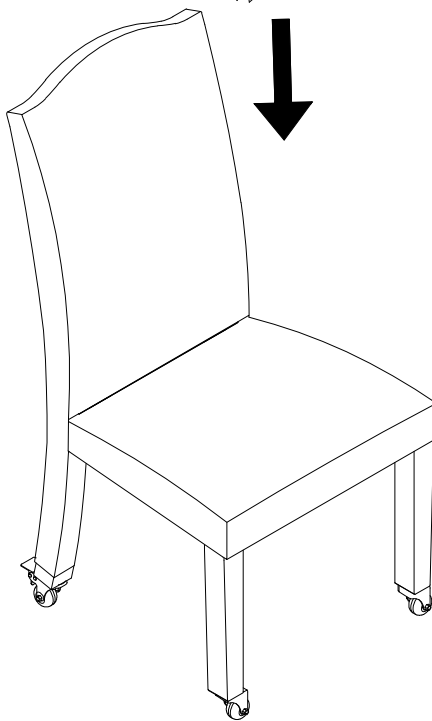
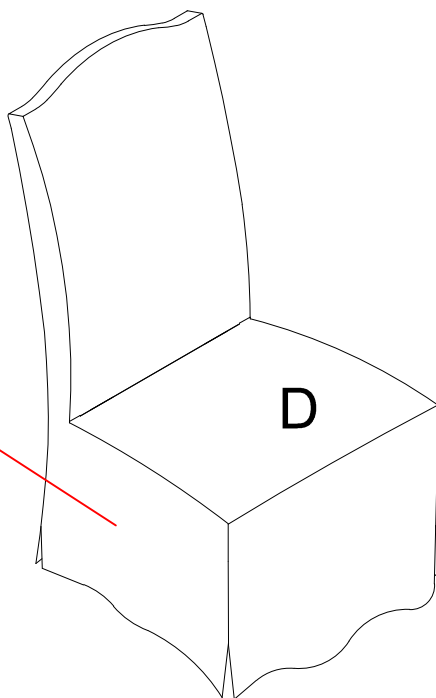

ASSEMBLY INSTRUCTIONS

STEP-8

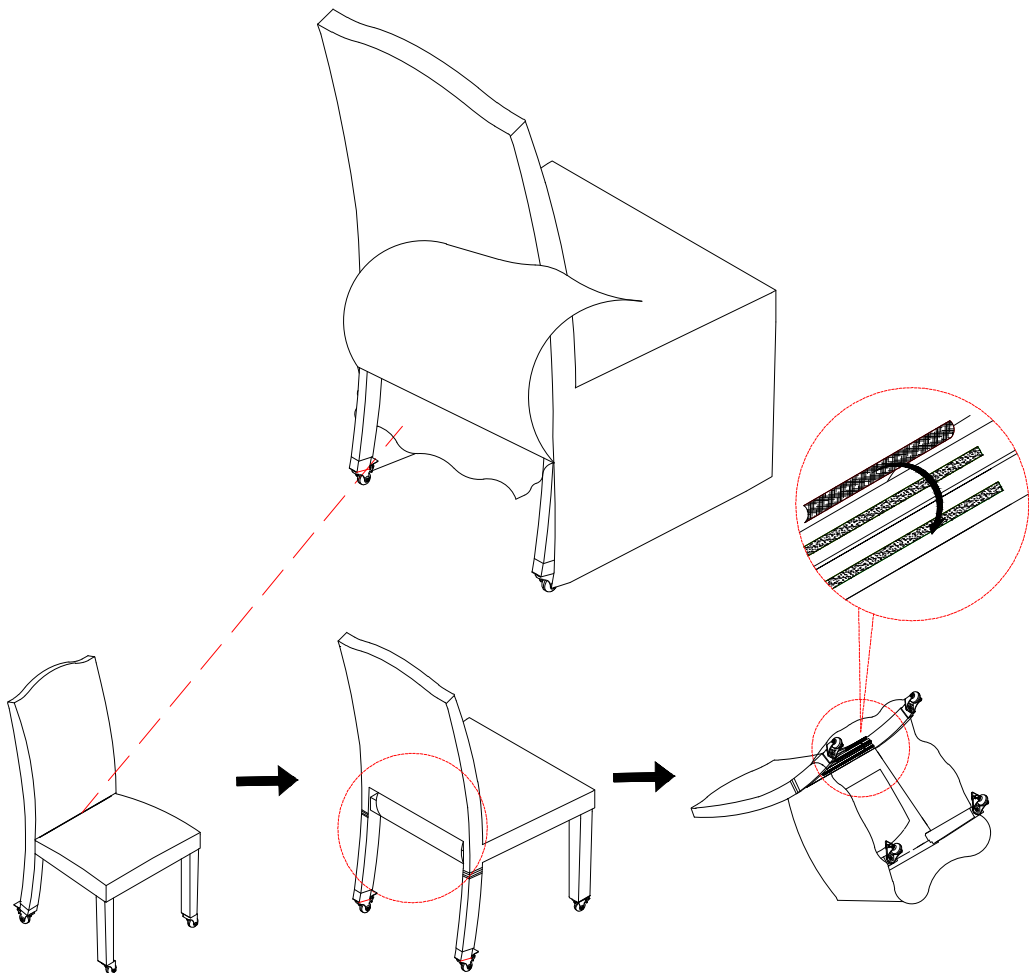

ASSEMBLY INSTRUCTIONS

STEP-9

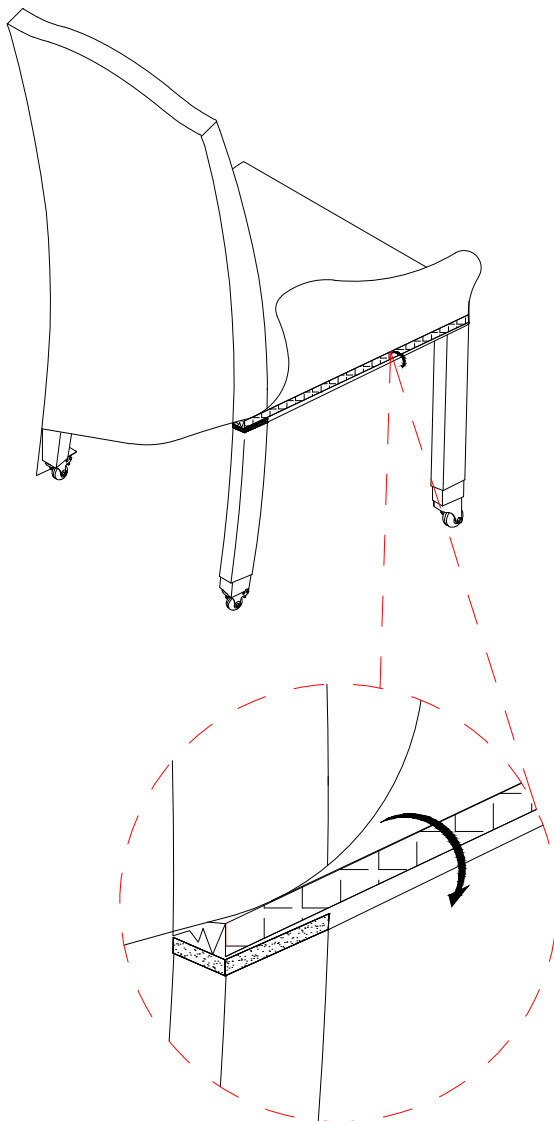

ASSEMBLY INSTRUCTIONS

STEP-10

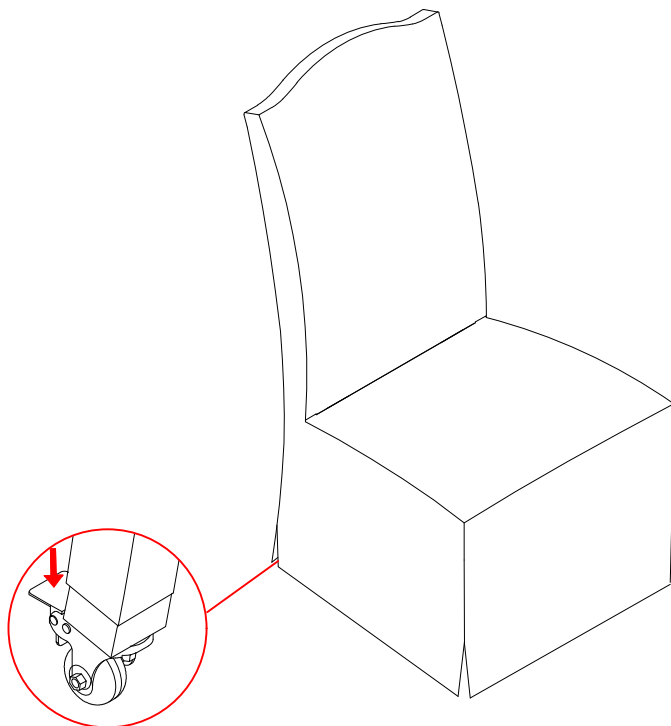

Press down to lock,
press down again to unlock

WARRANTY

1. We strive to offer high-quality products, and we also try our best to satisfy each and every customer that orders from us with product or service as needed.
2. We provide 30 days warranty starting from the time you receive the item. Each customer must provide a record of their order such as the order number, or item receipt for any items that are out of the warranty period you may also still receive.
3. Replacement parts by purchasing them with our company if they are available.

Are you having difficulty
With assembly? Missing parts?
Please send email with your order No to
customerservice@hulalahome.com
For return, please check the return policy with
the retailer or market place you bought from.

Appreciate your purchasing from us.
Pop up your life by our furniture piece!