

ASSEMBLY INSTRUCTIONS

BUNK BED

Thank you for purchasing this quality product. Be sure to check all packing materials carefully for small parts which may have come loose inside the carton during shipment. Separate, identify and count all parts and hardware. Compare with the parts list to be sure all parts are present.

**“DO NOT TIGHTEN SCREWS
UNTIL COMPLETELY ASSEMBLED”**

SIZE OF MATTRESS AND FOUNDATION (SUPPORT)

This bed is designed to use a twin mattress (37½”-38½”x74-75”) and bunkie board (37½”x74”). The total thickness must not exceed 8” inches. Do not use mattress without the proper bunkie board of safe foundation.

Note: There must be at least 5” inches from top surface of mattress to top edge of guardrails.

REPLACEMENT PARTS.

Replacement parts, including additional guardrails, may be obtained from place of purchase or original distributor.

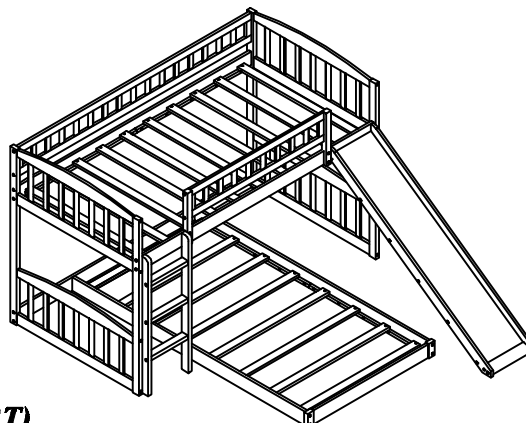

SAFETY WARNINGS!

- 1- Follow the information on the warning label appearing on the upper bunk end structure and on the carton. Do not remove warning label from bed.
- 2- Always use the recommended size mattress or mattress support, or both, to help prevent the likelihood of entrapment or falls.
- 3- Surface of mattress must be at least 5 inches below the upper edge of guardrails.
- 4- Do not allow children under 6 years of age to use the upper bunk.
- 5- Prohibit more than one person on upper bunk.
- 6- Periodically check and ensure that the guardrail, ladder and other components are in their proper position free from damage, and that all connectors are tight.
- 7- Do not allow horseplay on or under the bed and prohibit jumping on the bed.
- 8- Always use the ladder for entering and leaving the upper bunk.
- 9- Do not use substitute parts. Contact distributor or dealer for replacement parts.
- 10- Use of a night light may provide added safety precaution for a child using the upper bunk.
- 11- If the bunk bed will be placed next to a wall, the guardrail that runs the full length of the bed should be placed against the wall to prevent entrapment between the bed and the wall.
- 12- Always use guardrails on both long sides of the upper bunk.
- 13- The use of water or sleep flotation mattresses is prohibited.
- 14- Keep these instructions for future reference.
- 15- Strangulation Hazard - Never attach or hang items to any part of the bunk bed that are not designed for use with the bed: for example, but not limited to, hooks, belts, and jump ropes, etc.



IMPORTANT: PLEASE READ INSTRUCTIONS BEFORE STARTING THE ASSEMBLY

ASSEMBLY INSTRUCTIONS

BUNK BED

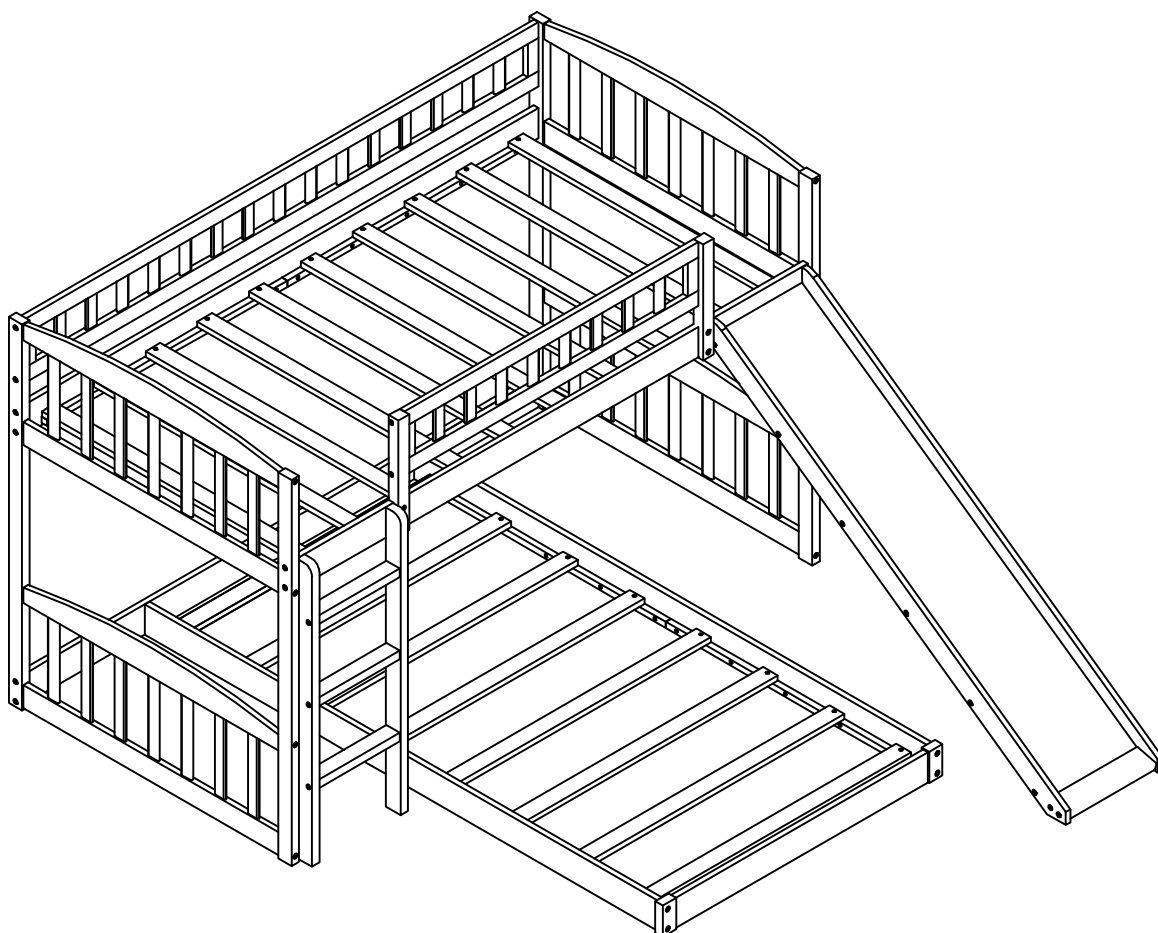

Thank you for purchasing this quality product. Be sure to check all packing material carefully for small parts which may have come loose inside the carton during shipment. Separate, identify and count all parts and hardware.

Compare with the parts list to be sure all parts are present.

"DO NOT TIGHTEN SCREWS UNTIL COMPLETELY ASSEMBLED"

- Use of power tool to assemble this product will invalidate any claim and damage this product making unsafe !!!
- Please assemble on a clean soft surface to avoid damage.

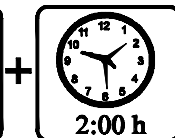
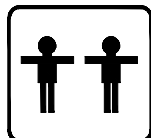
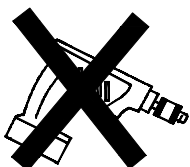

Tools Required

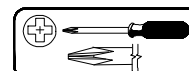

(Not Included)

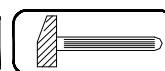

(Not Included)

IMPORTANT:

PLEASE READ INSTRUCTION BEFORE STARTING THE ASSEMBLY

Detail View - BUNK BED WITH SLIDE

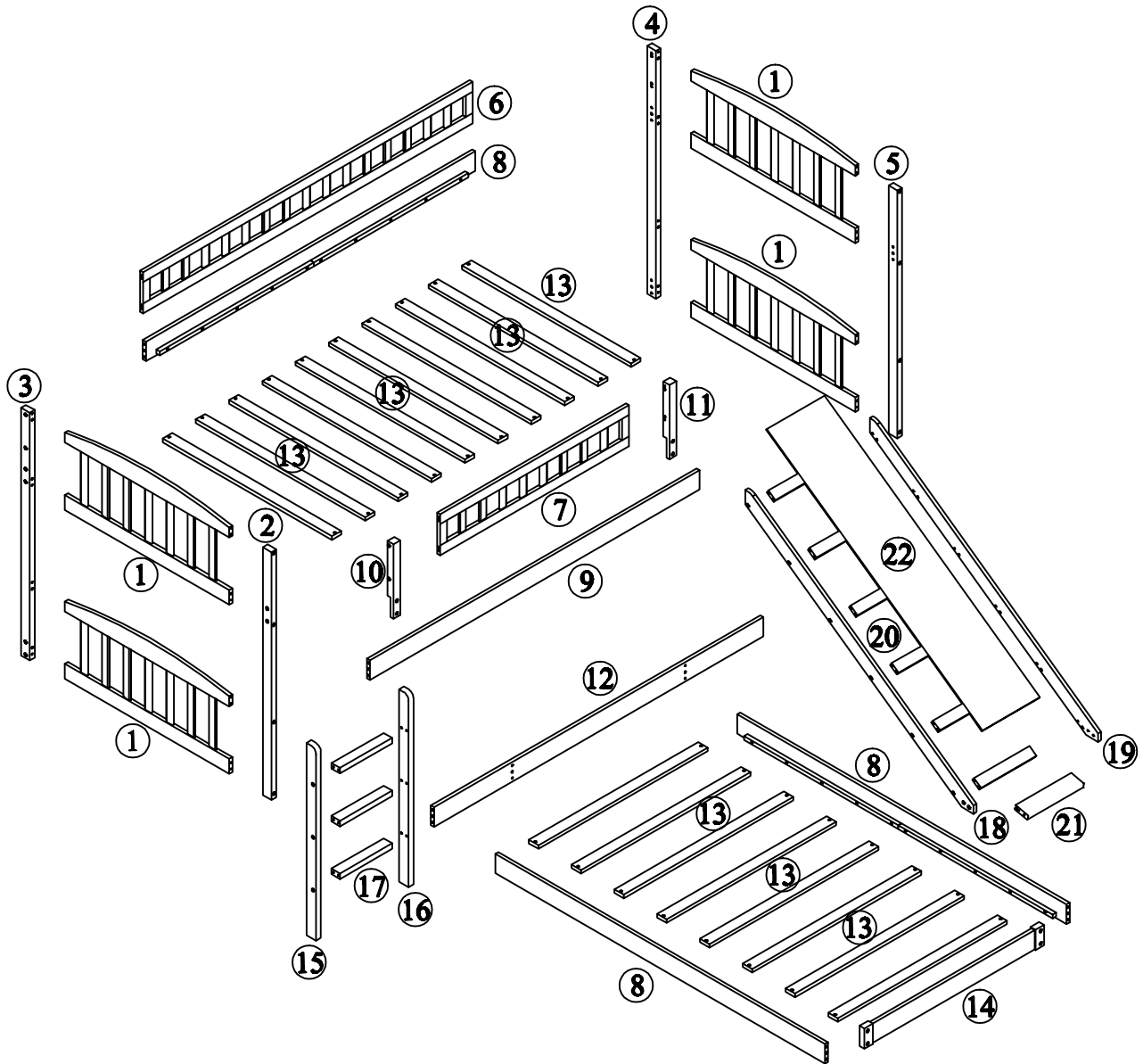

Identifying the Hardware - Identify the hardware using the illustrations below.

Part List

1

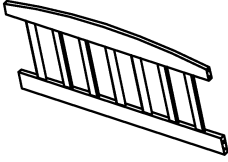

Headboard - 4pc

13

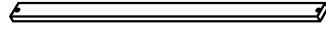

Bed board - 18pc

Part List

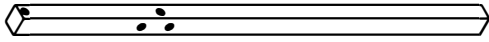
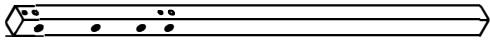
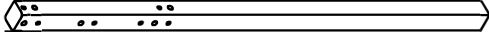
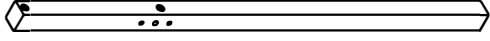
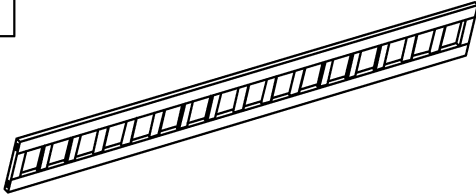
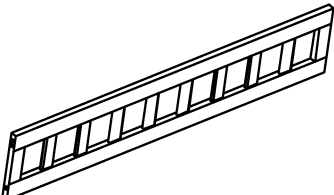
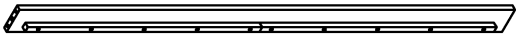
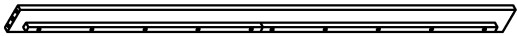
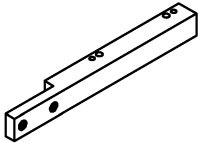
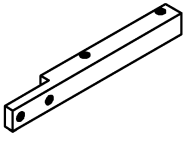
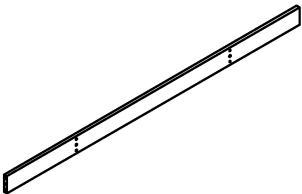
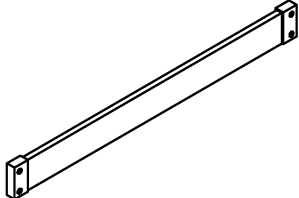
<p>2</p>  <p>Left front bed column- 1pc</p>	<p>3</p>  <p>Left rear bed column - 1pc</p>
<p>4</p>  <p>Right rear bed column - 1pc</p>	<p>5</p>  <p>Right front bed column- 1pc</p>
<p>6</p>  <p>Back guard rail frame - 1pc</p>	<p>7</p>  <p>Front guard rail frame - 1pc</p>
<p>8</p>  <p>Bed side plate - 3pc</p>	<p>9</p>  <p>Bed side plate - 1pc</p>
<p>10</p>  <p>Left front guard rails support - 1pc</p>	<p>11</p>  <p>Right front guard rails support - 1pc</p>
<p>12</p>  <p>Lower bed side plate - 1pc</p>	<p>14</p>  <p>Foot board - 1pc</p>

15

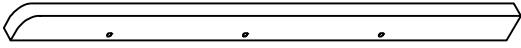

Bed ladder column - 1pc

16

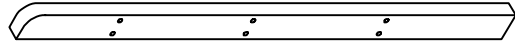

Bed ladder column - 1pc

17

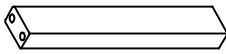

Step of bed ladder - 3pc

18

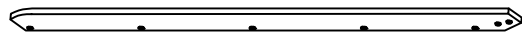

Slide column - 1pc

19

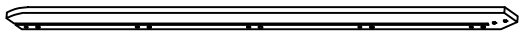

Slide column - 1pc

20

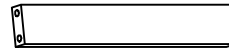

Slide support wood - 6pc

21

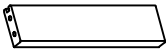





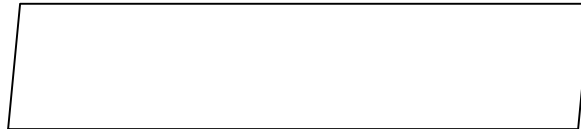

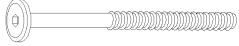
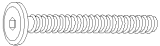

Slide baffle - 1pc

22

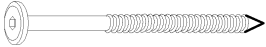

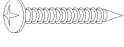
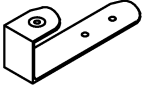
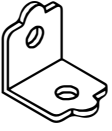
Skate - 1pc



Hardware List

<p>A</p>  <p>ø13x1/4"x80mm</p>	<p>B</p>  <p>ø13x1/4"x30mm</p>	<p>C</p>  <p>ø13x1/4"x50mm</p>
<p>Hex-Head bolts(20pcs)</p>	<p>Hex-Head bolts(4pcs)</p>	<p>Hex-Head screw(26pcs)</p>
<p>D</p>  <p>ø13*1/4"x80mm</p>	<p>E</p>  <p>ø10x13mm</p>	<p>F</p>  <p>ø8xø4x30mm</p>
<p>Hex-Head screw(20pcs)</p>	<p>Horizontal-Hole bolts(20pcs)</p>	<p>Round head screw(36pcs)</p>
<p>G</p>  <p>ø75x23x24mm</p>	<p>H</p>  <p>20x20x19mm</p>	<p>I</p>  <p>ø7xø3.5x18mm</p>
<p>Stair hook(4pcs)</p>	<p>L-Bracket (1pc)</p>	<p>Flat head screw(14pcs)</p>
<p>J</p>  <p>4mm</p>	<p>K</p>  <p>ø10x40mm</p>	
<p>Allen key(1pcs)</p>	<p>Wood dowel(52pcs)</p>	

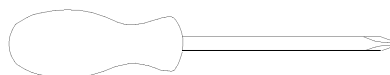
ASSEMBLY TOOLS REQUIRED (NOT INCLUDED)



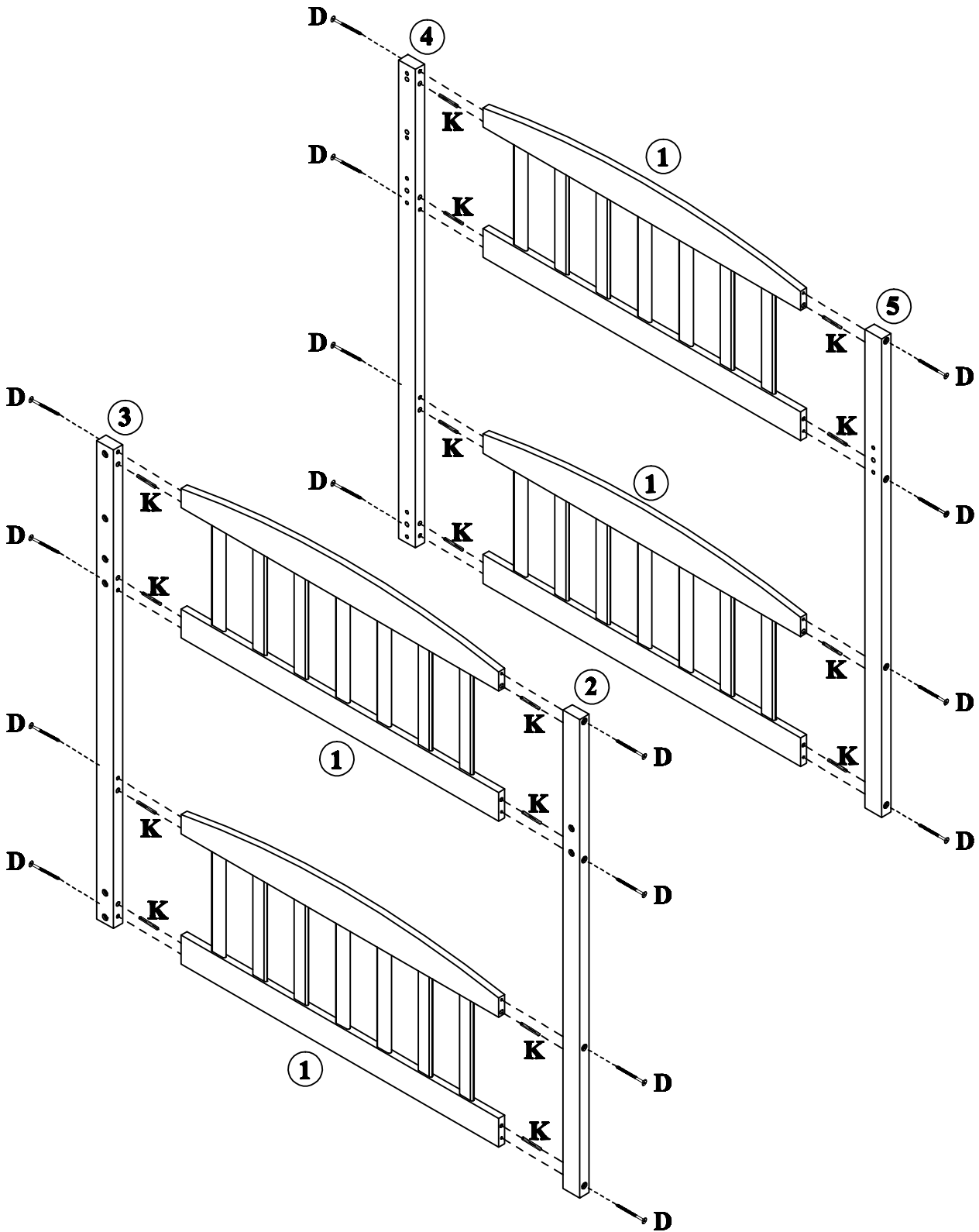

STEP: 1

D	K
	
16PCS	16PCS



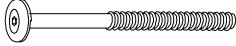

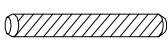
STEP: 2

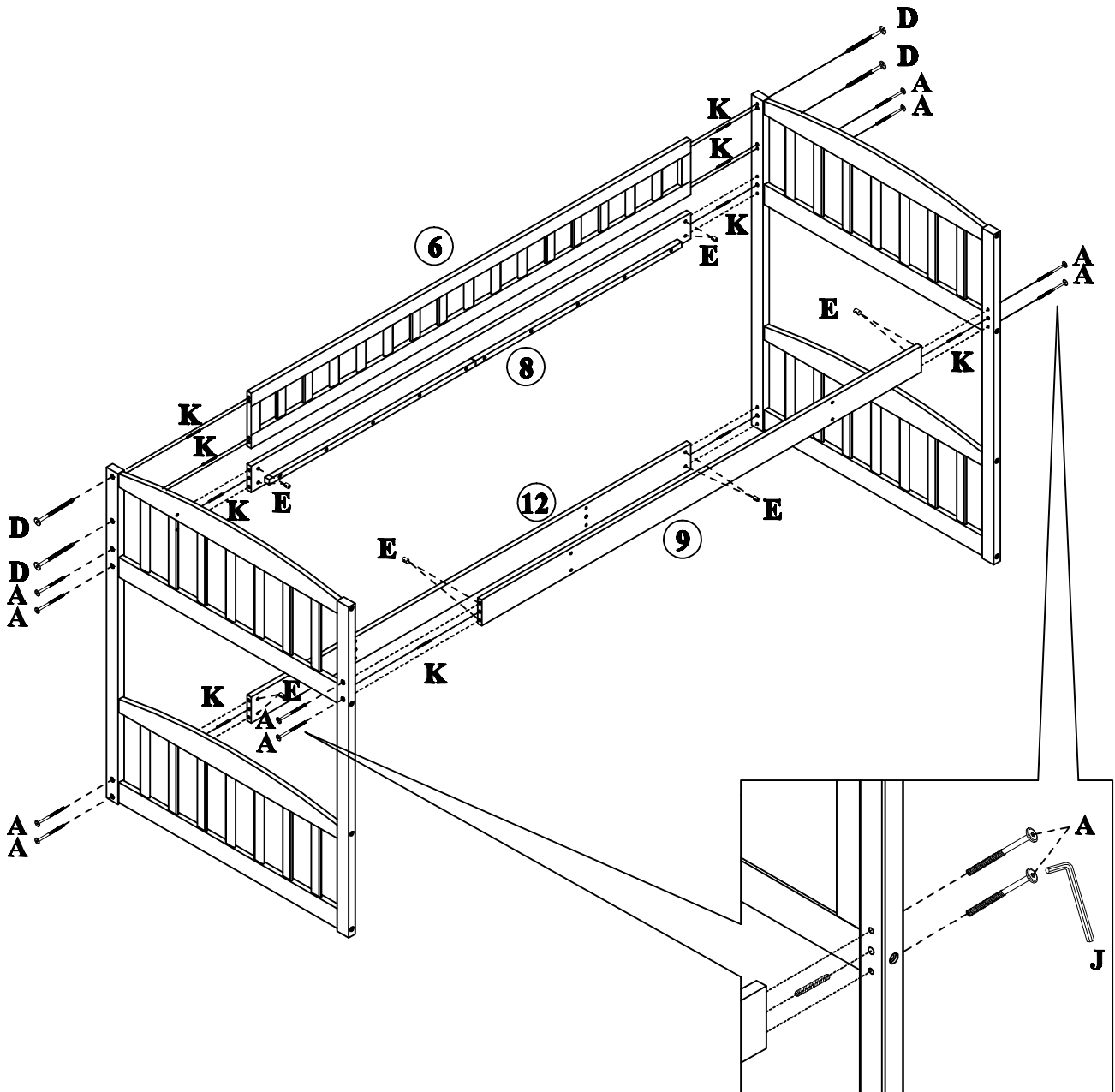
A	D	E	K
			
12PCS	4PCS	12PCS	10PCS

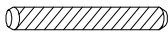

STEP: 3

K	C
	
4 PCS	4PCS

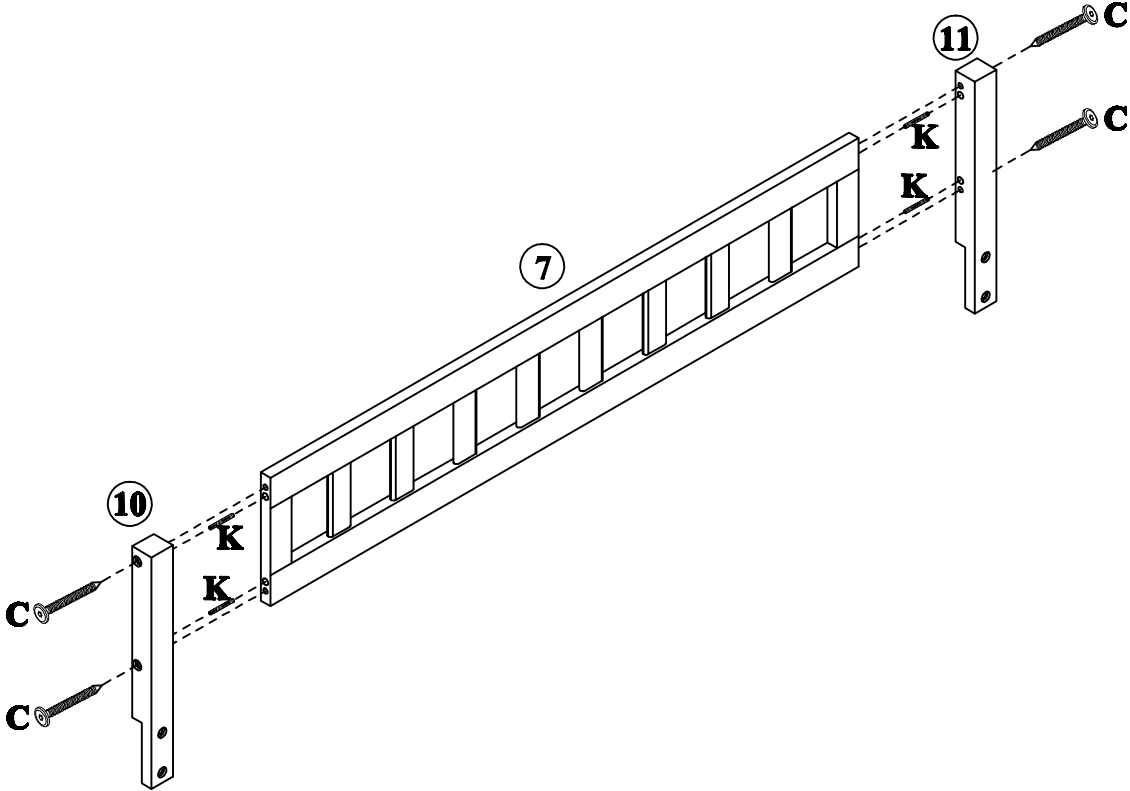

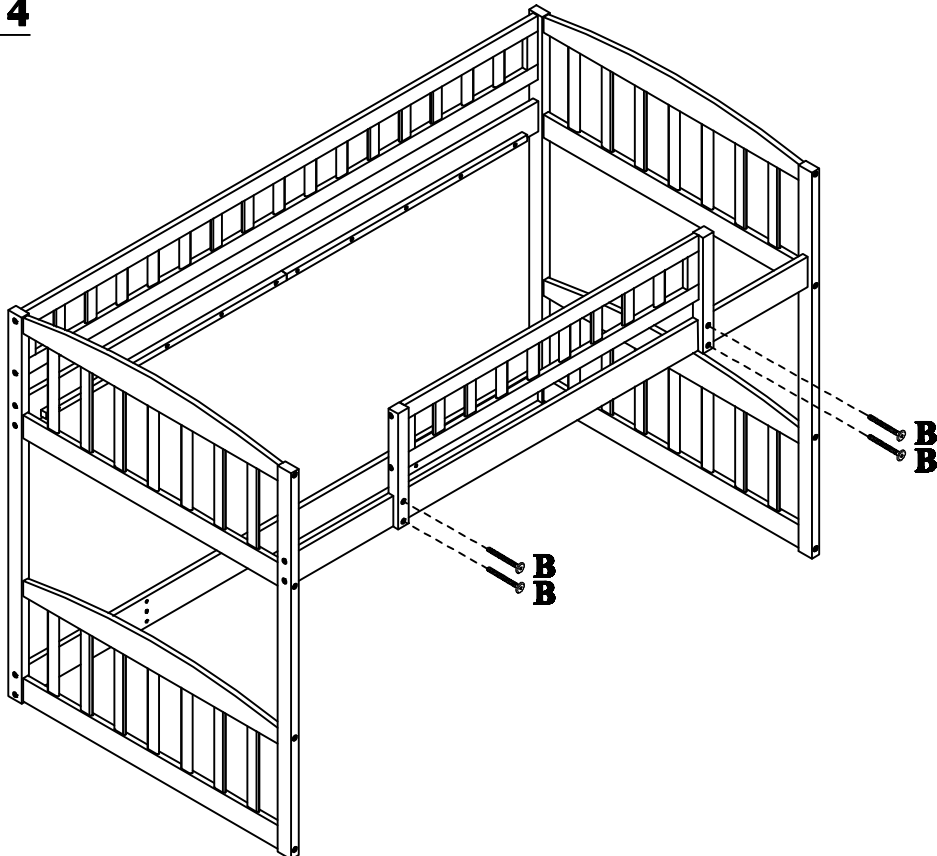

STEP: 4

B

4PCS

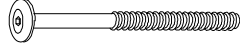
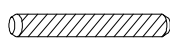

STEP: 5

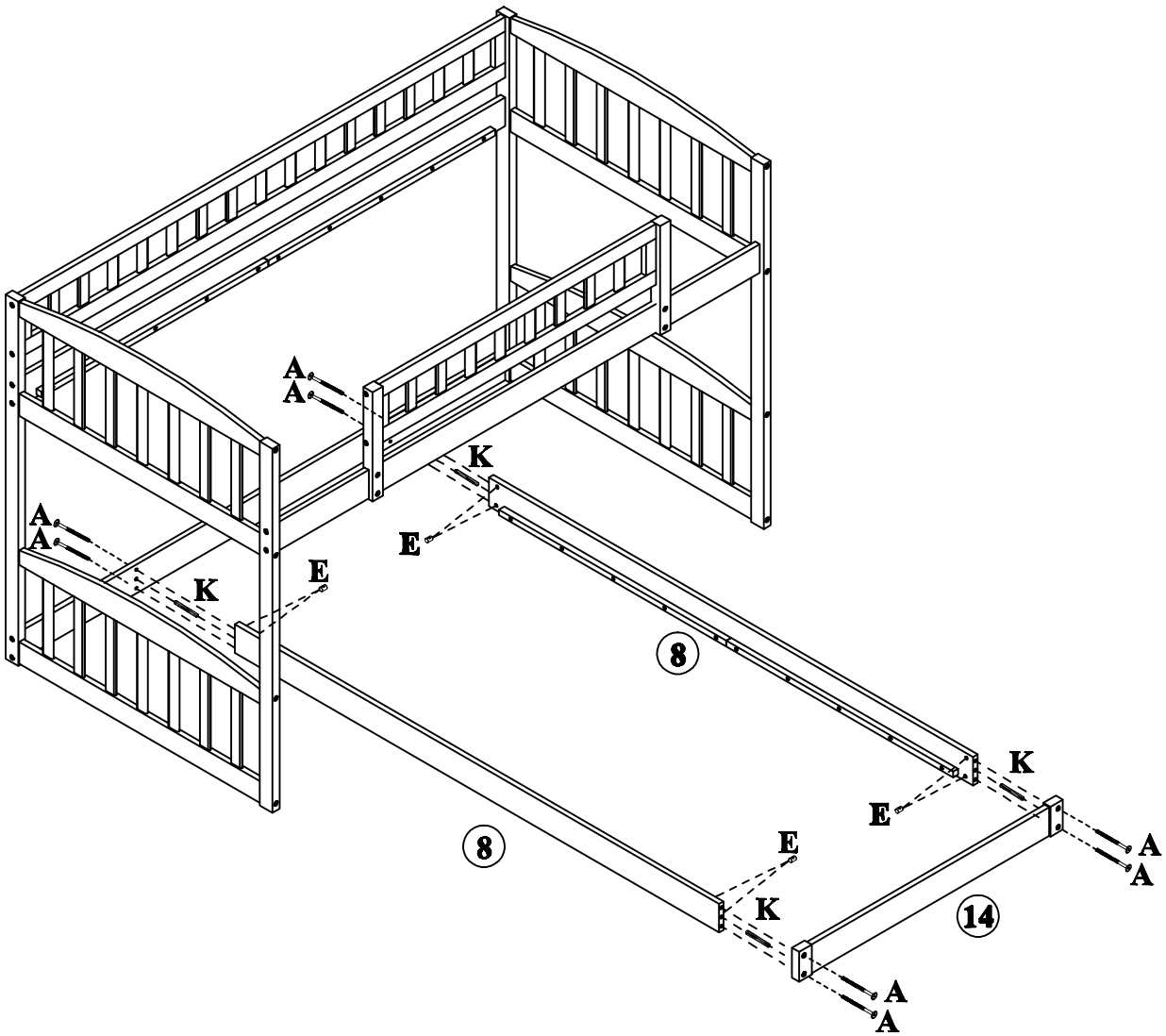
A	K	E
		
8PCS	4PCS	8PCS



STEP: 6



F

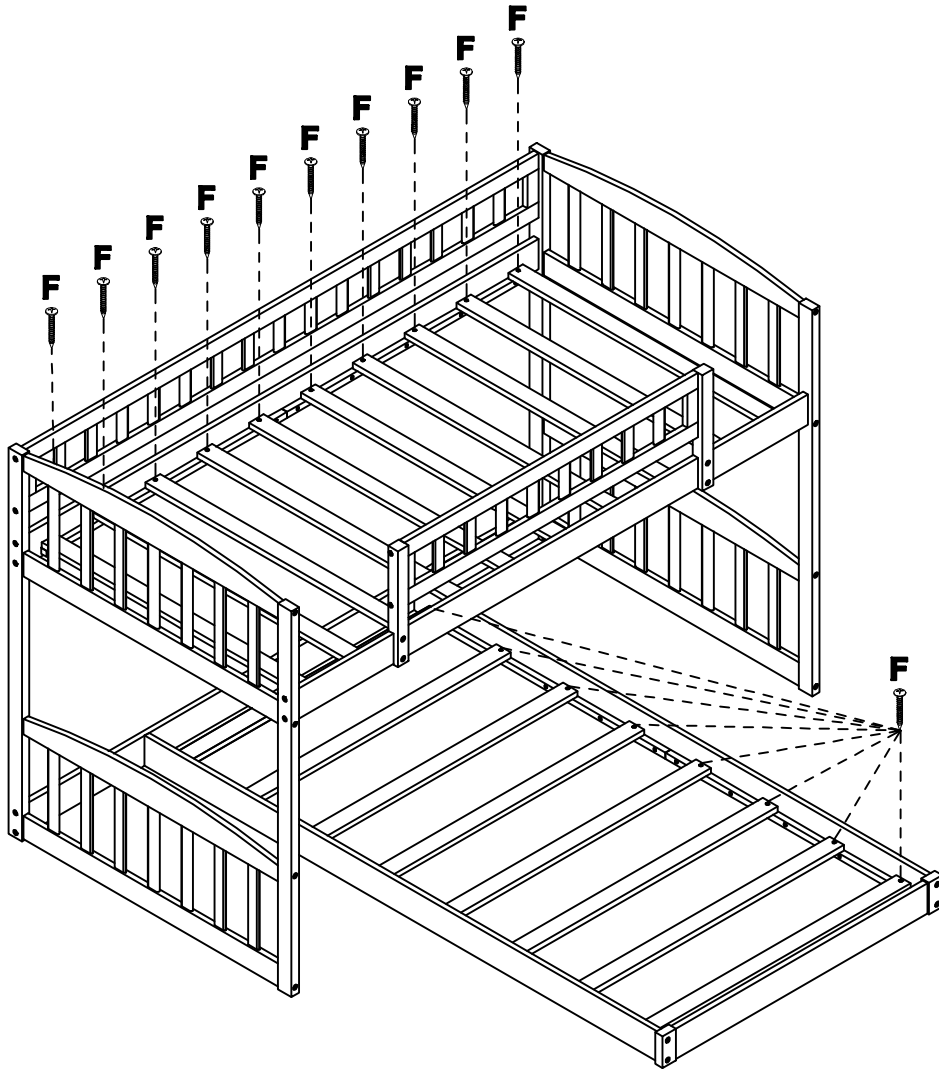

36PCS



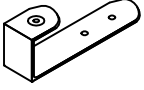

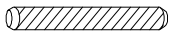
STEP: 7

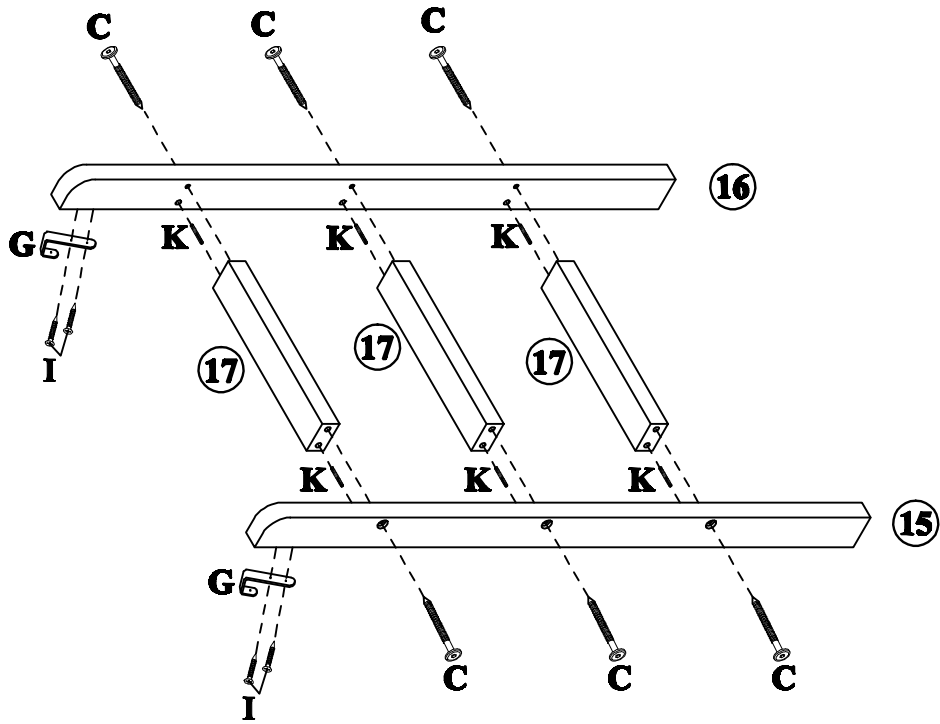
I	G	C	K
			
4PCS	2PCS	6PCS	6PCS

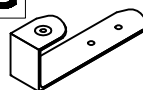
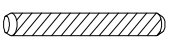

STEP: 8

C	I	G	K
			
16PCS	4PCS	2PCS	12PCS

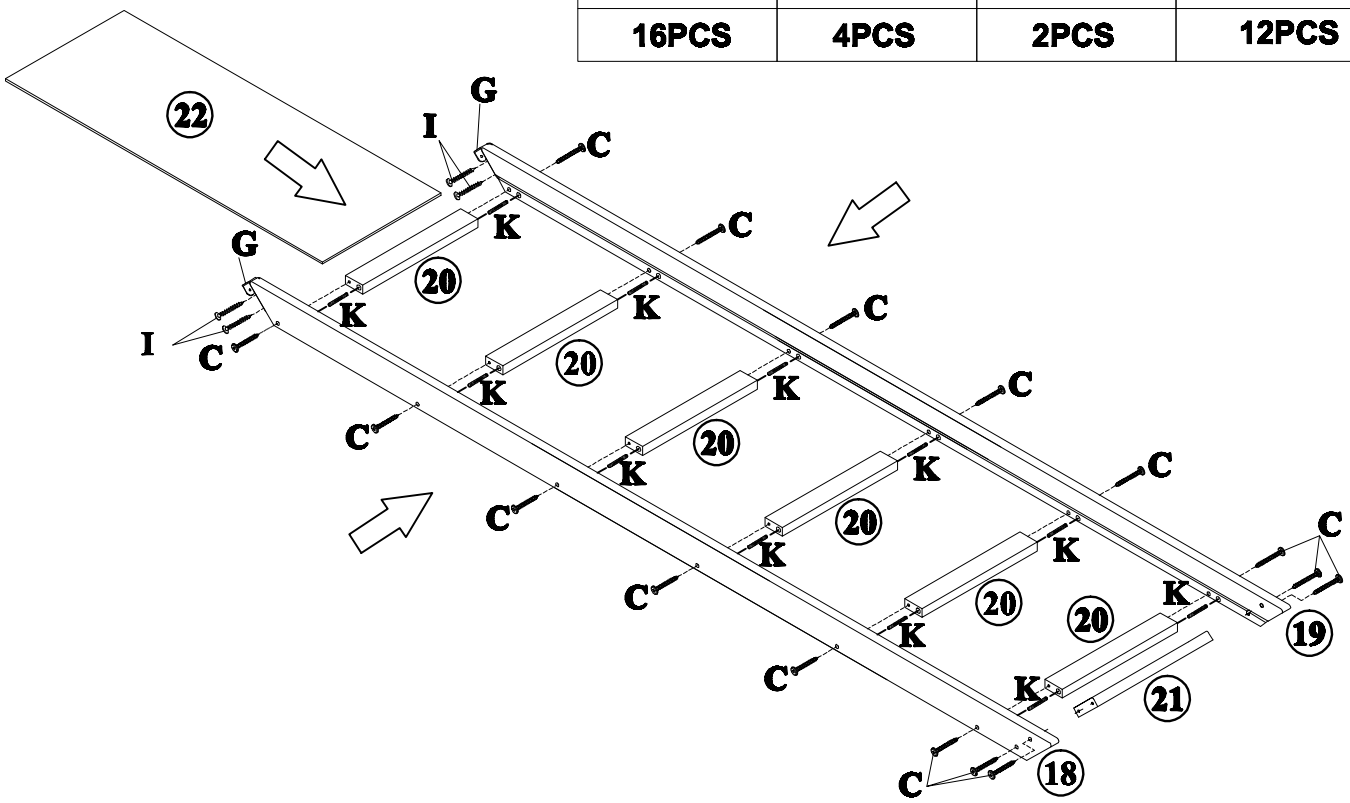

STEP: 9

I



6PCS

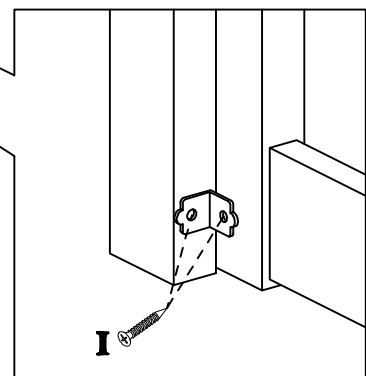
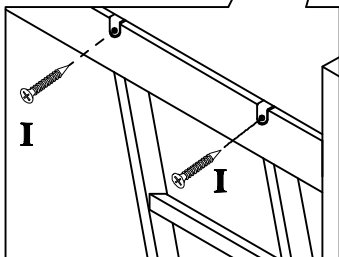
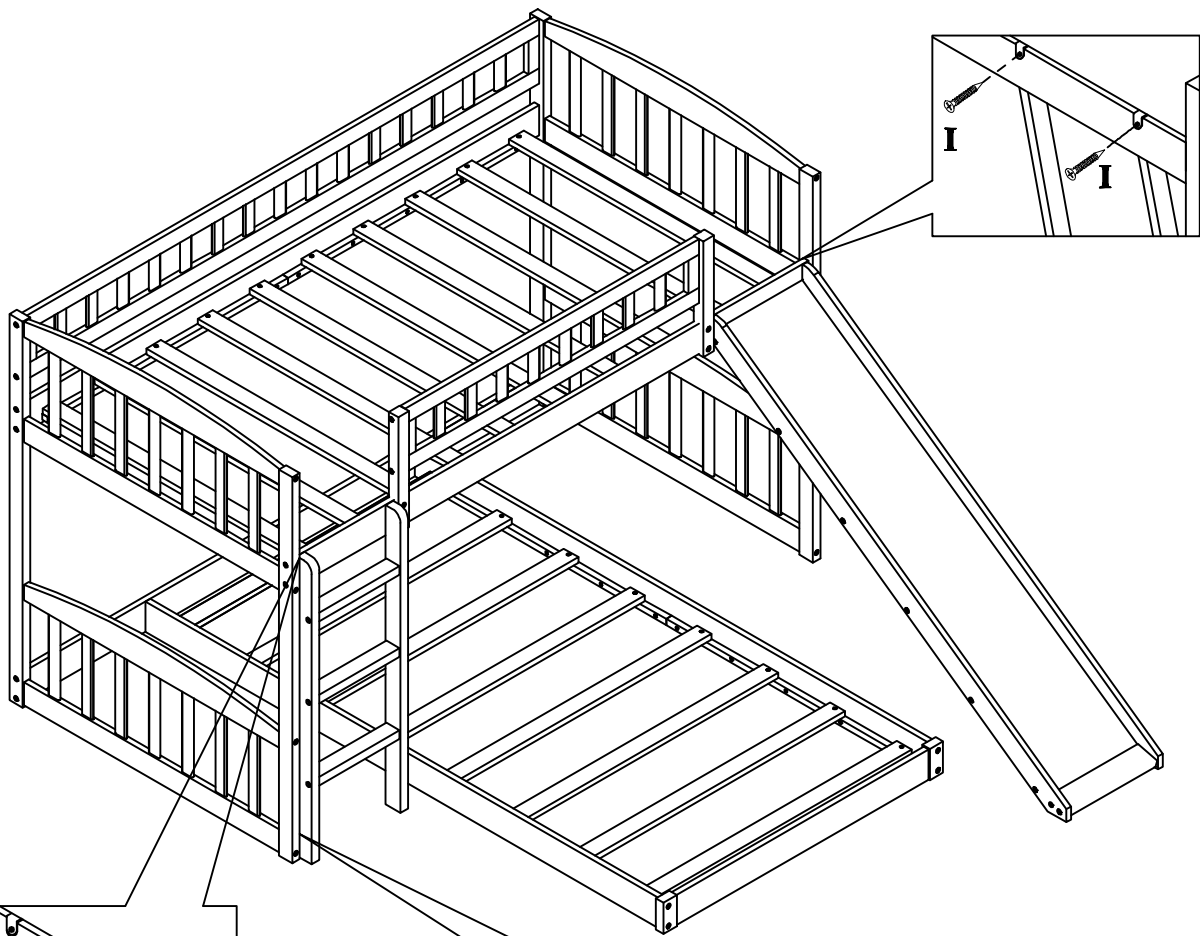

STEP:10

