







AL 1 PC	AR 1 PC	B 1 PC	C 1 PC	D 1 PC	E 2 PCS
					
M6*12	M8*35	M6	M8		
F 10PCS	G 4 PCS	H 10 PCS	I 4 PCS	J 4 PCS	K 4 PCS
					
M6	M8				
L 1 PC	M 2 PCS				

①





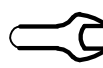
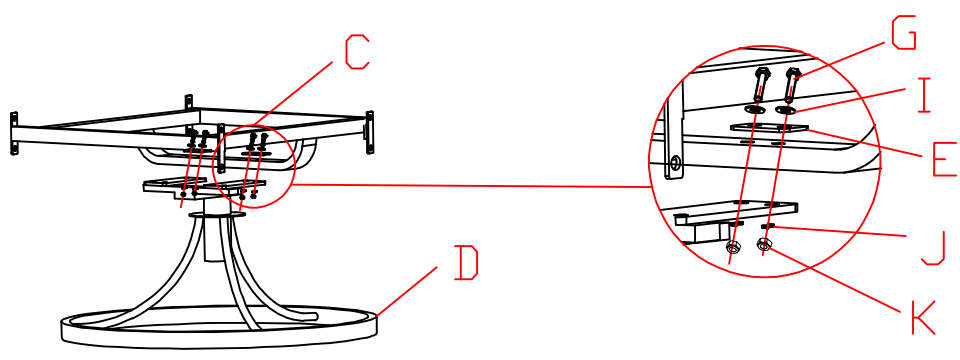
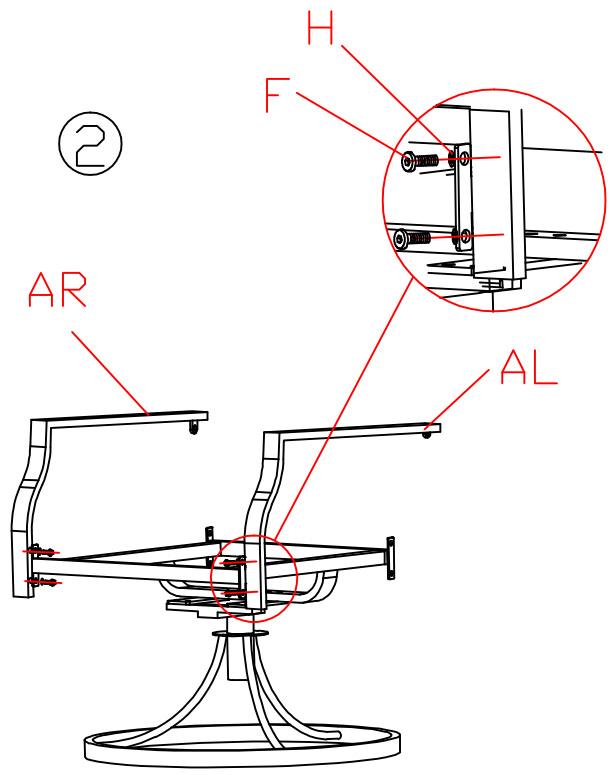

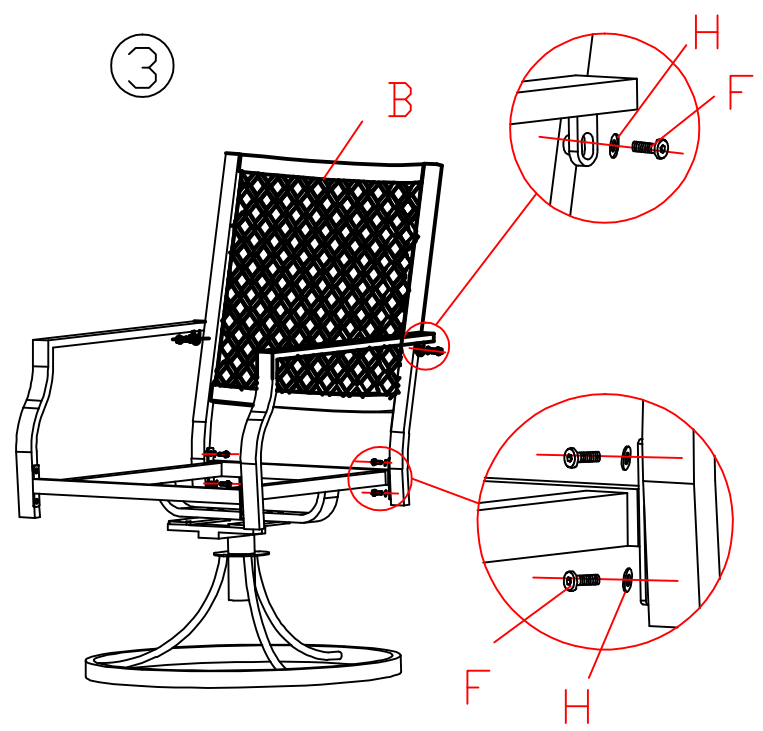

②

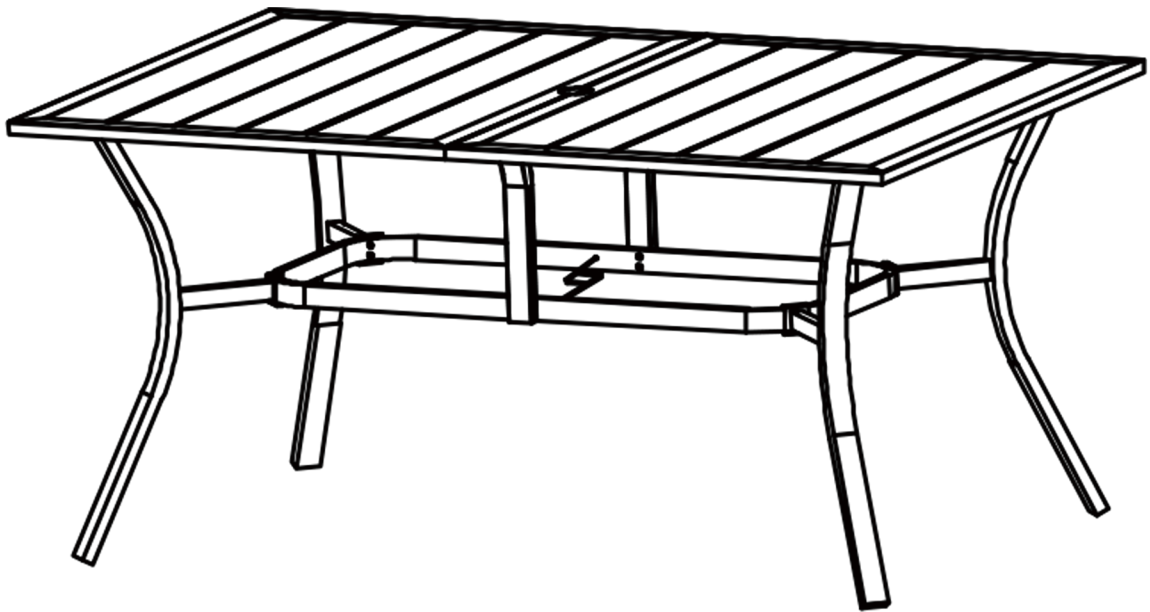

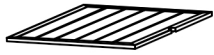
③

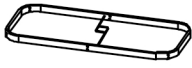

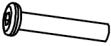

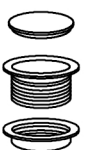
A		2
B		4
C		2
D		1
E	 M6*12	8
F	 M6*20	4
G	 M6*25	12
H	 M6	24
I	 M6	1
J		1

