

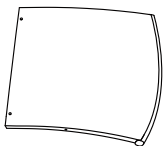







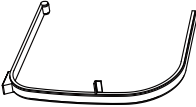
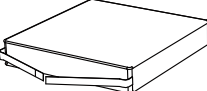

READ & SAVE BELOW INSTRUCTIONS BEFORE ASSEMBLY

1. PLEASE SEPARATE AND IDENTIFY ALL PARTS, MAKING SURE THAT YOU HAVE ALL OF THE PARTS LISTED.
2. TO AVOID ANY SCRATCH DURING ASSEMBLY, PLEASE ASSEMBLE ON A SOFT MAT OR SIMILAR.
3. PLEASE ASSEMBLE STEP BY STEP AND FOLLOW THE INSTRUCTIONS.
4. WASHERS MUST BE USED.
5. WHILE EACH SCREW AND NUT IS PROPERLY FASTENED, DO NOT OVER FASTEN IT.
6. DO NOT COMPLETELY FASTEN EACH SCREW AND NUT UNTIL ALL THE SCREWS ARE PROPERLY FIXED.

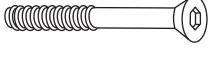
SPARE PARTS		
CODE	PARTS	QTY.
A		1
B		1
C		1
D		1
E		1
F		1

HARDWARE		
CODE	PART	QTY.
G	 M6x20	4
H	 M6x35	4
I	 M6x50	2
J		8
K		8
L		2
M		1

ASSEMBLY PROCESSING STEP

1

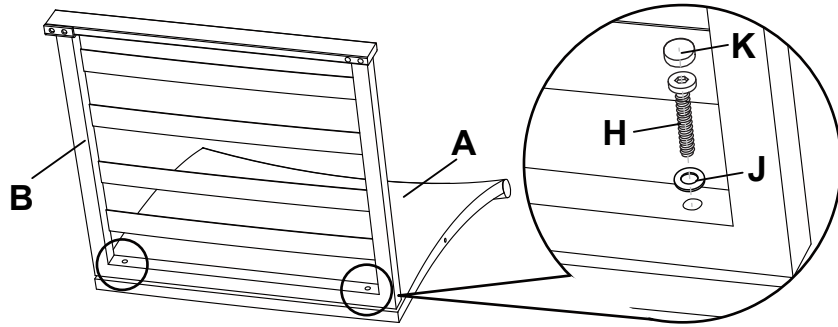

2

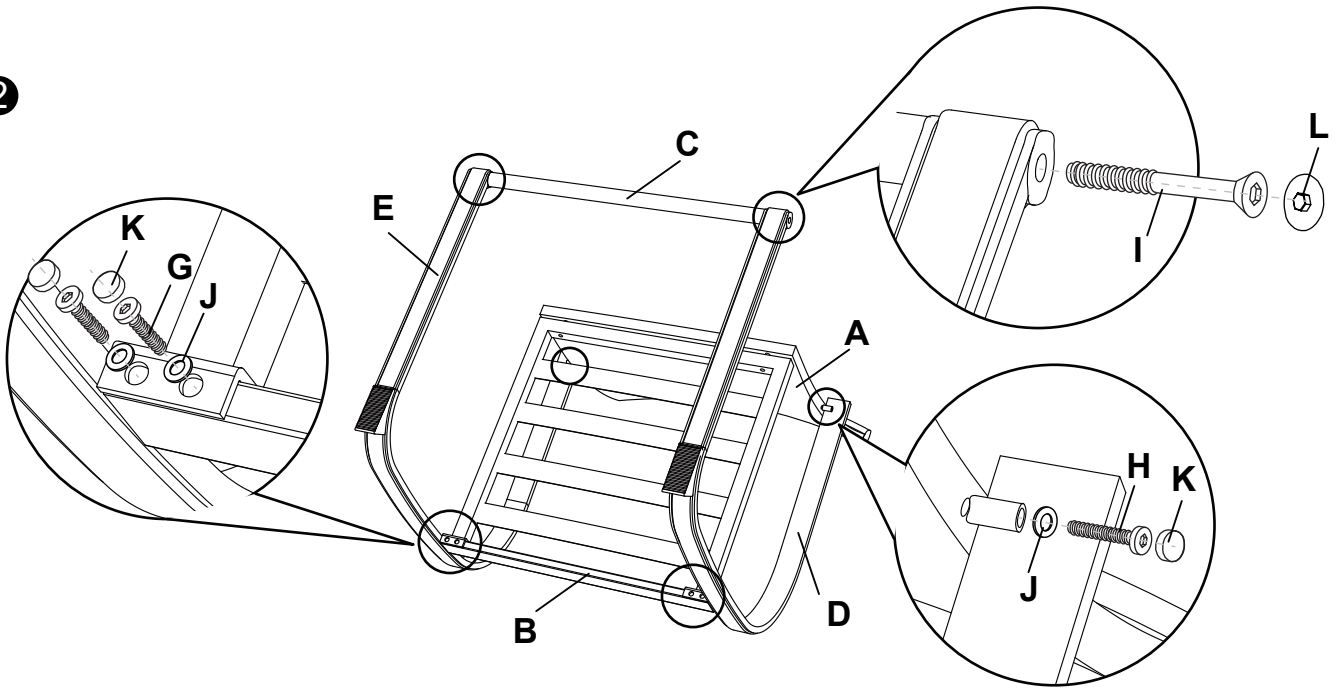

3

