

ASSEMBLY INSTRUCTIONS

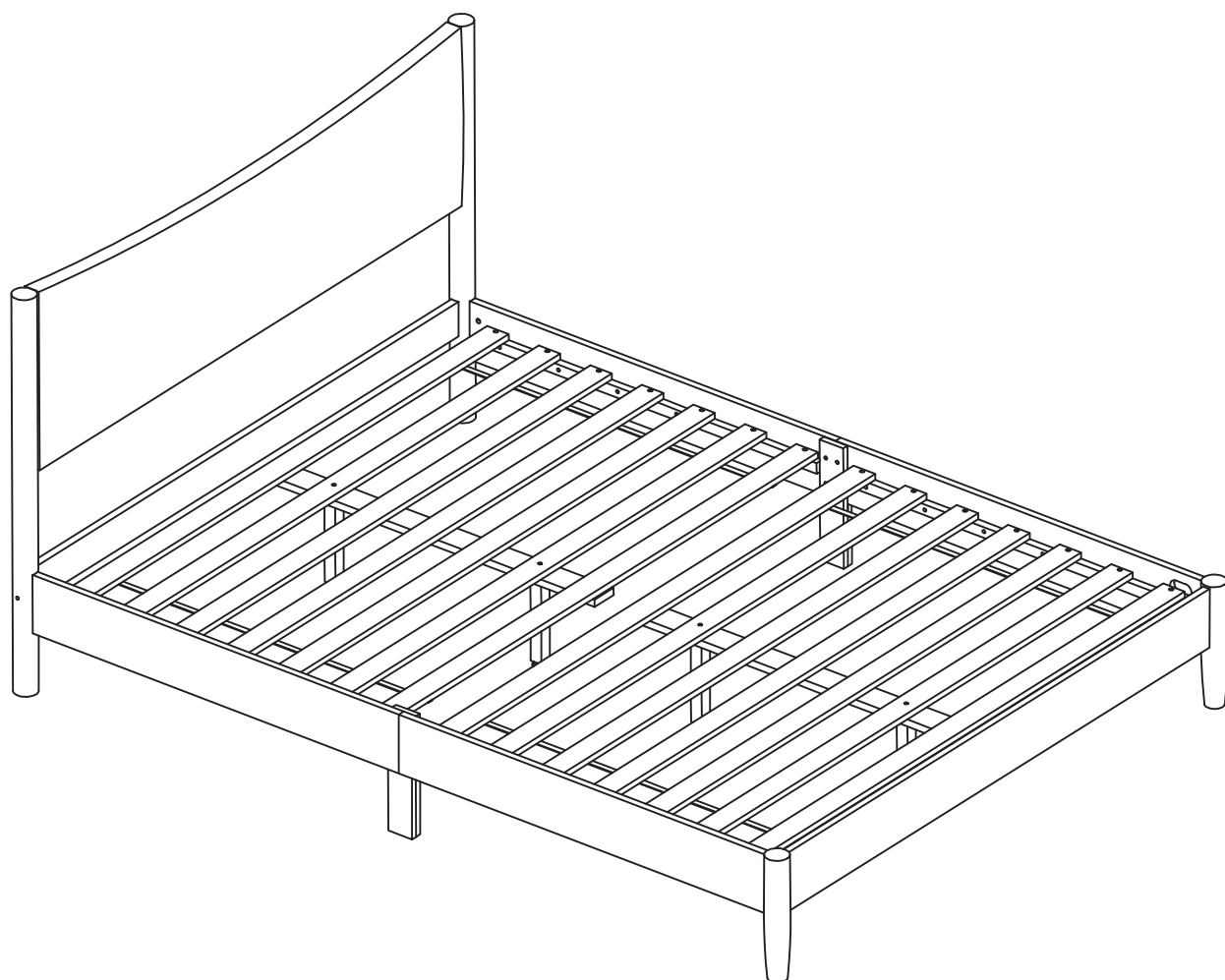

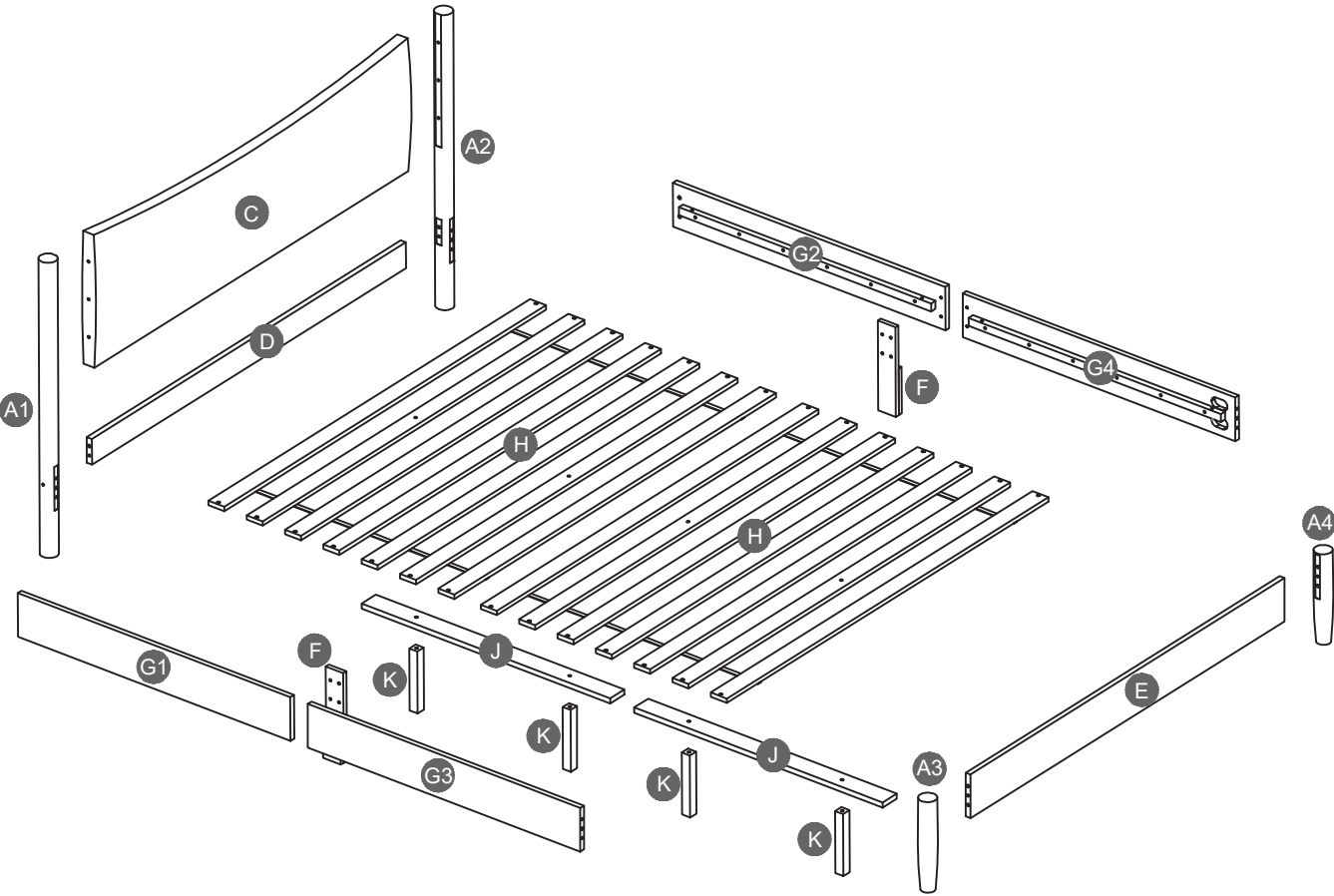





QUEEN BED WITH HEADBOARD

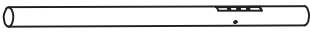



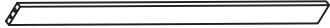

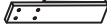
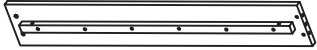
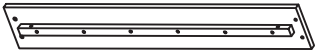
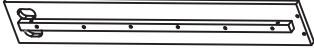
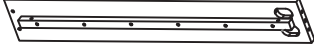

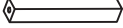

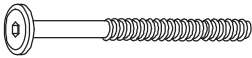

Detail View

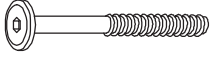
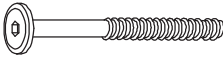

Part List

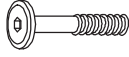
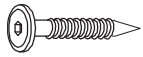
A1  Leg (Headboard Left) - 1pc	A2  Leg (Headboard Right) - 1pc	A3  Leg (Footboard Left) - 1pc
A4  Leg (Footboard Right) - 1pc	C  Panel (Headboard)- 1pc	D  Bottom Panel (Headboard) - 1pc
E  Panel (Footboard) - 1pc	F  Side Rail Support (Left & Right) - 2pcs	G1  Side Rail Left (Headboard) - 1pc
G2  Side Rail Right (Headboard) - 1pc	G3  Side Rail Left (Footboard) - 1pc	G4  Side Rail Right (Footboard) - 1pc
H  Bed Slats - 2Sets	J  Center Rail - 2pcs	K  Support Leg - 4pcs

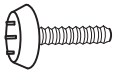
Hardware List





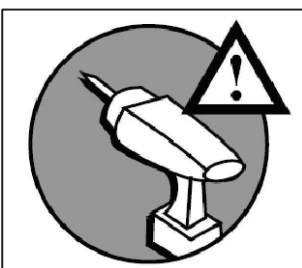
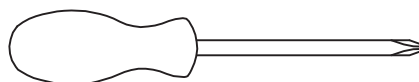

1  M6 x 90mm JCBC (6pcs)	2  M6 x 15mm Barrel Nut (6pcs)	3  M10 x 30mm Wood Dowel (10pcs)
4  M6 x 50mm JCBC (6pcs)	5  M6 x 60mm JCBC (10pcs)	6  M6 Half Moon Nut (6pcs)
7  Flat Washer (12pcs)	8  Split Lock Washer (12pcs)	9  M6 x 25mm JCBC (8pcs)
10  M6 x 30mm JCBC-W (8pcs)	11  M4 x 25mm CSK Screw (20pcs)	12  Adjustable Screw (4pcs)
13  Flat Washer (8pcs)	14  M4 Allen Key (1pc)	

ASSEMBLY TOOLS REQUIRED (NOT INCLUDED)



PLEASE BE CAREFUL DO NOT DAMAGE THE HOLE POSITION WHEN YOU USE POWER TOOLS !



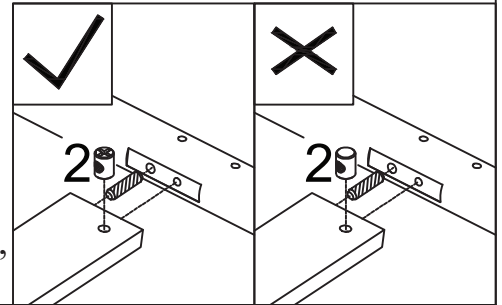
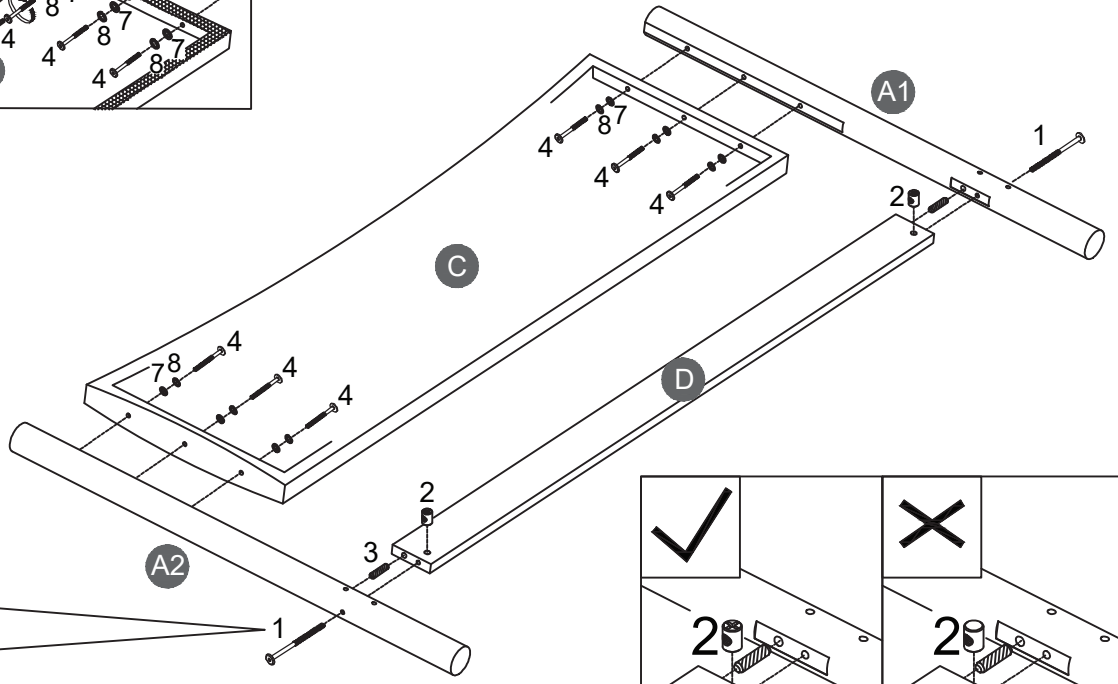
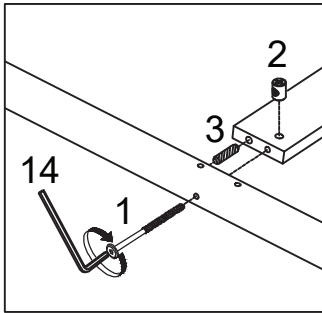
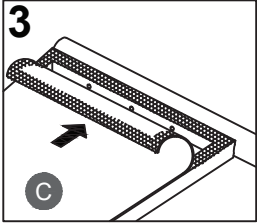
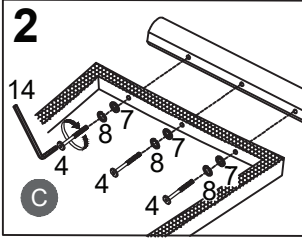
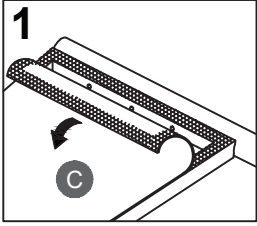

STEP 1:

1		2		3		4		7		8	
	2PCS		2PCS		2PCS		6PCS		6PCS		6PCS





Note: Part 2 will face up with the "x" mark on it, otherwise it cannot be tightened

STEP 2:

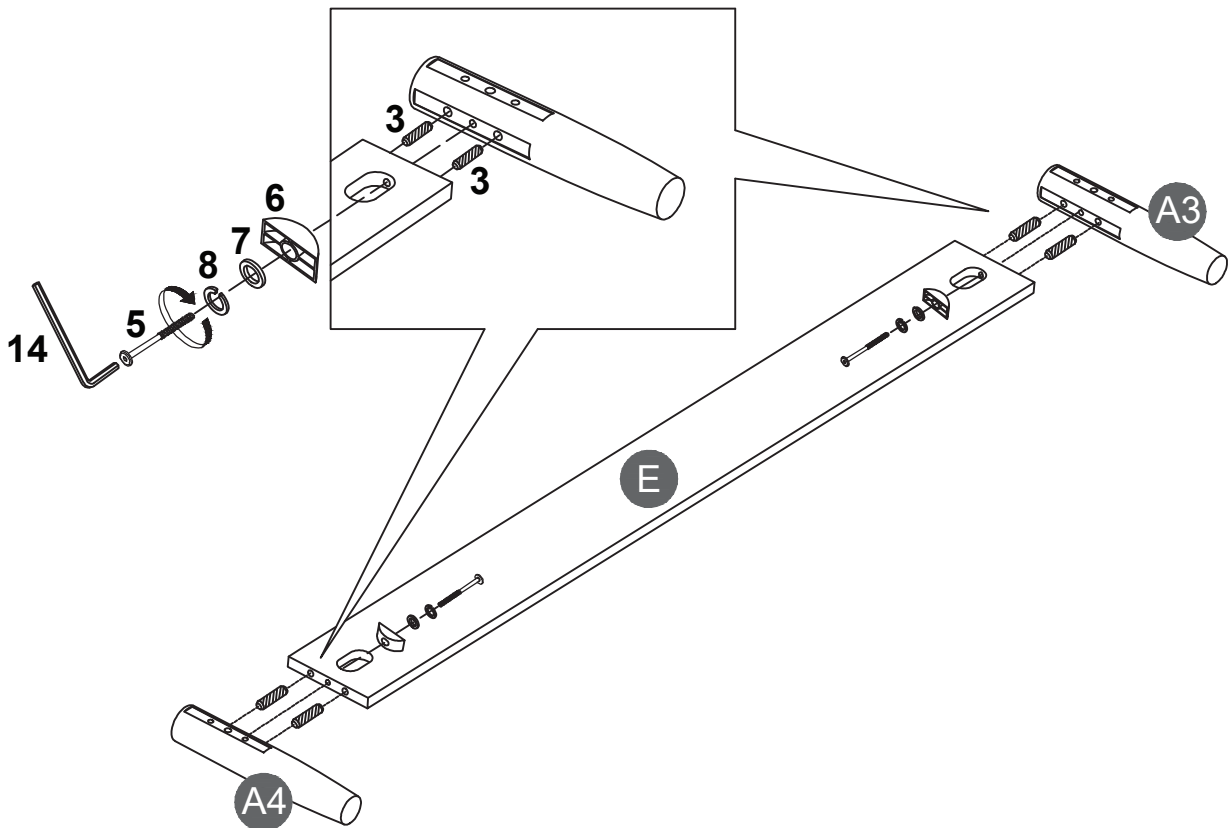
3		5		6		7		8	
	4PCS		2PCS		2PCS		2PCS		2PCS







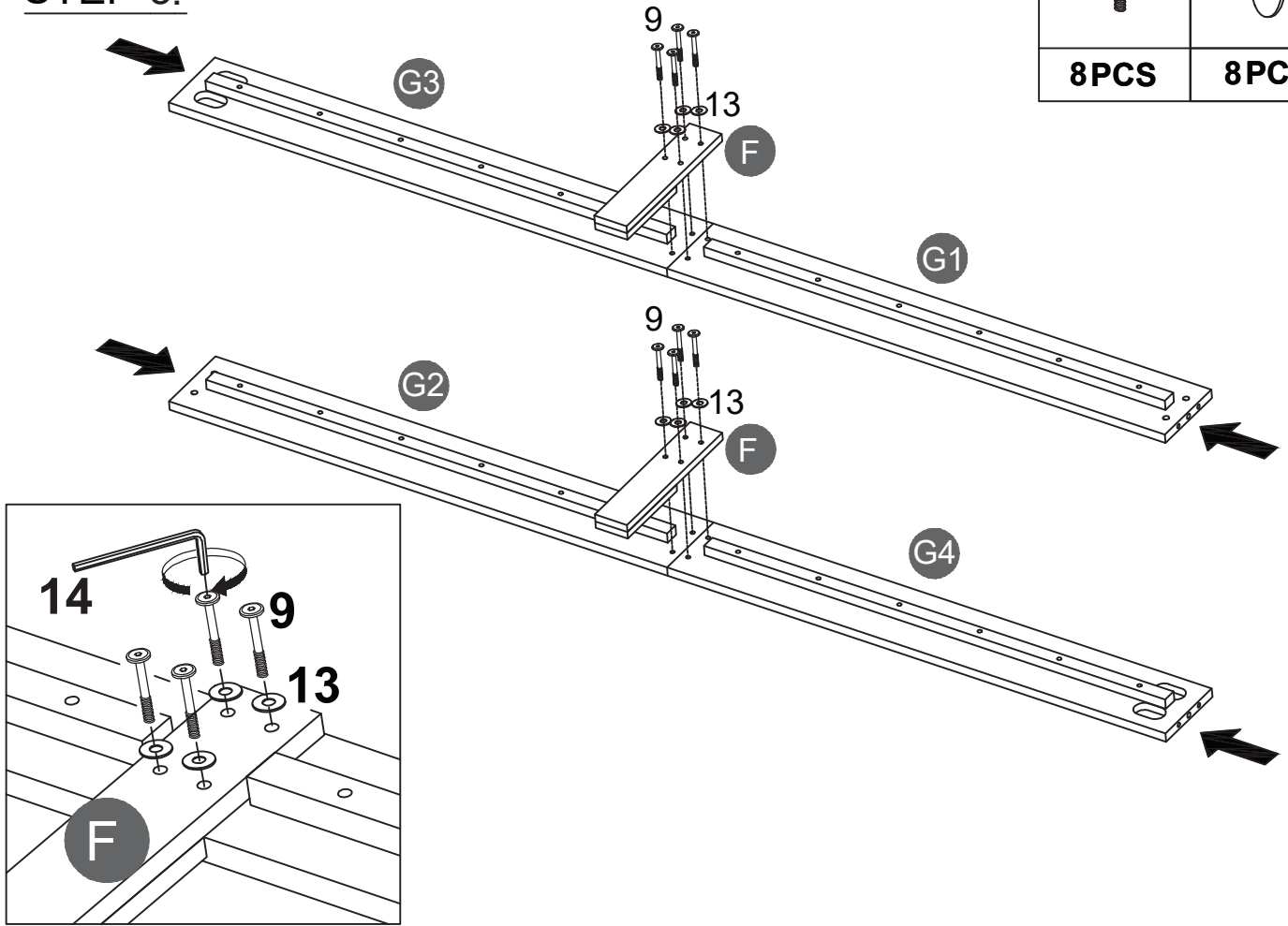

STEP 3:

9		13	
8PCS		8PCS	



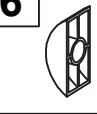

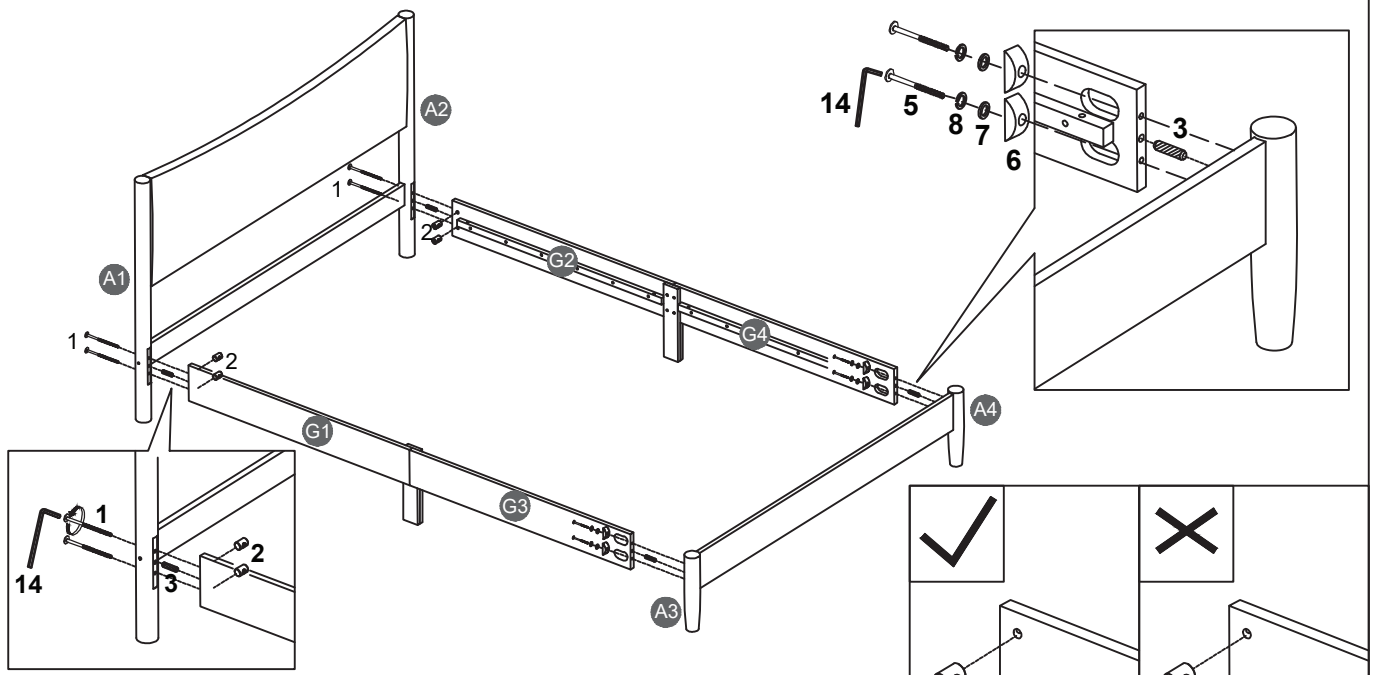

STEP 4:

1		2		3		5		6		7		8	
4PCS		4PCS		4PCS		4PCS		4PCS		4PCS		4PCS	



Note: Part 2 will face up with the "x" mark on it, otherwise it cannot be tightened

STEP 5:

5		10		11		12	
4PCS		8PCS		20PCS		4PCS	

