

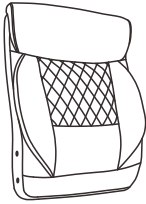

ASSEMBLY INSTRUCTION

Components List



A X1

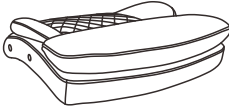

B X1

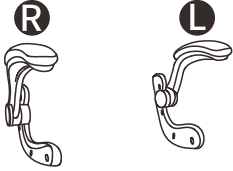

C X2

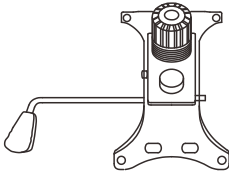

D X1

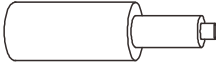

E X1



F X1

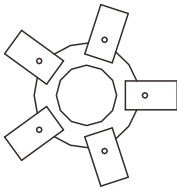

G X1



H X5

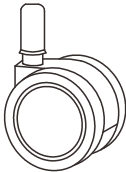

I X5

Components List

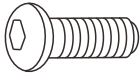

1 X5

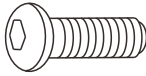

2 X4

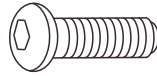

3 X8



4 X1



J X8

1

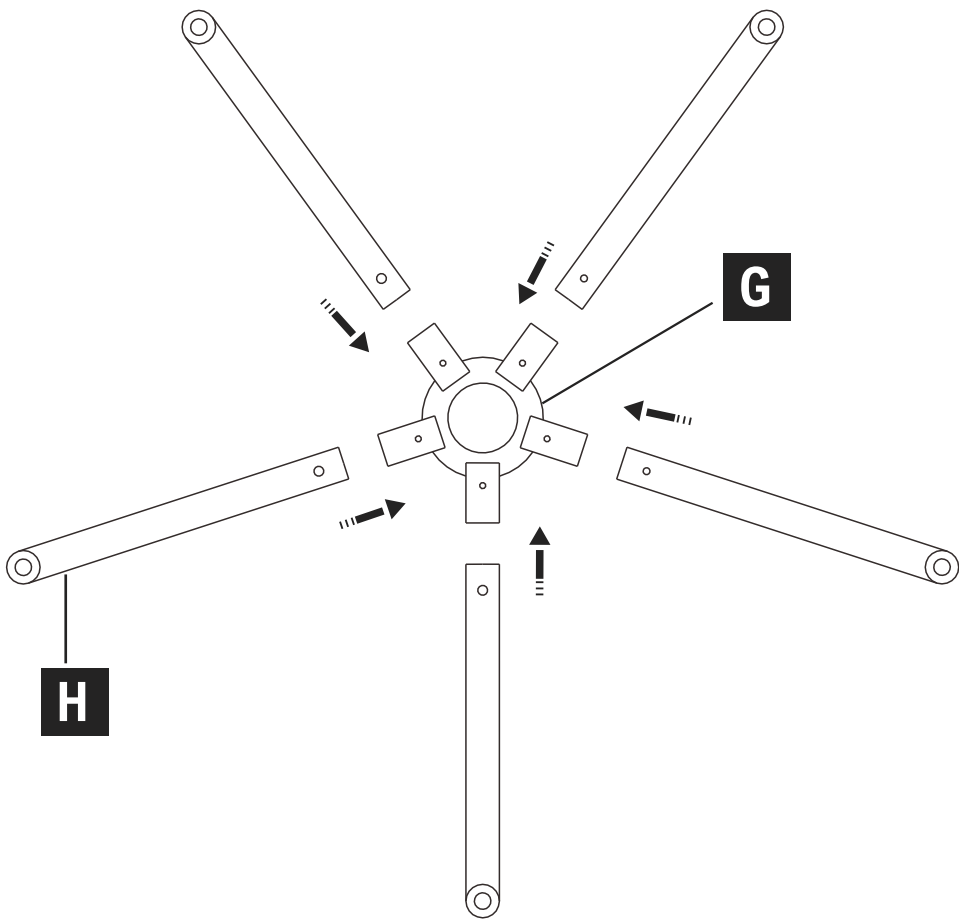

2

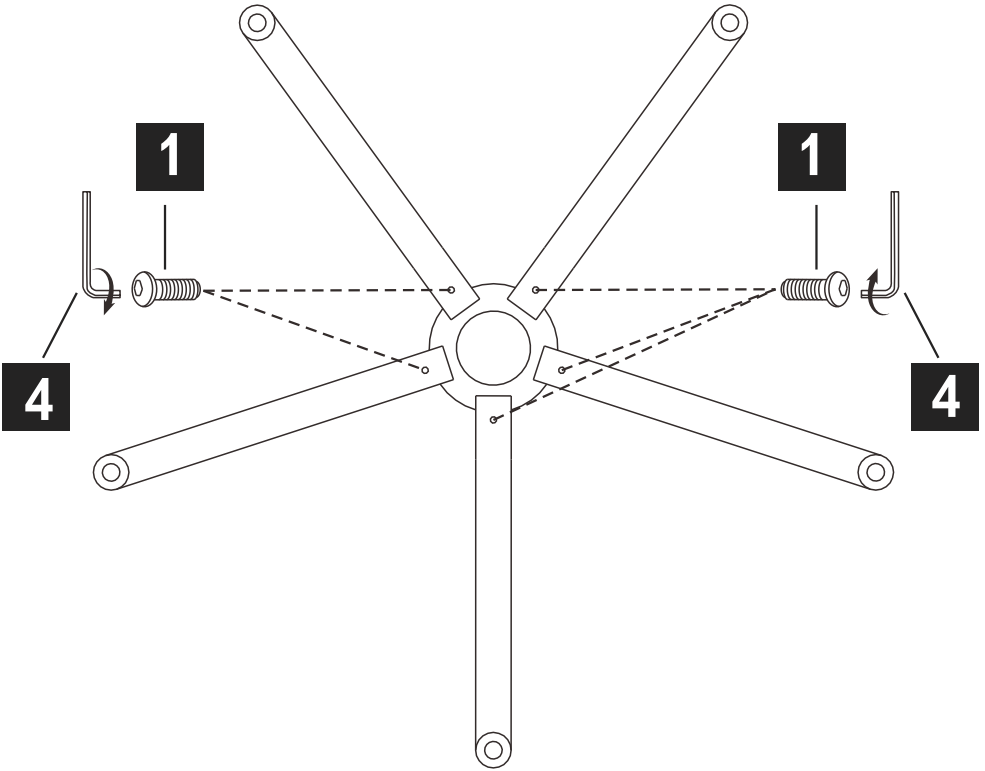
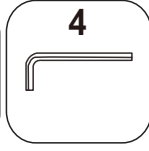
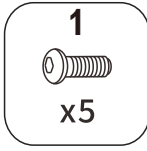

3

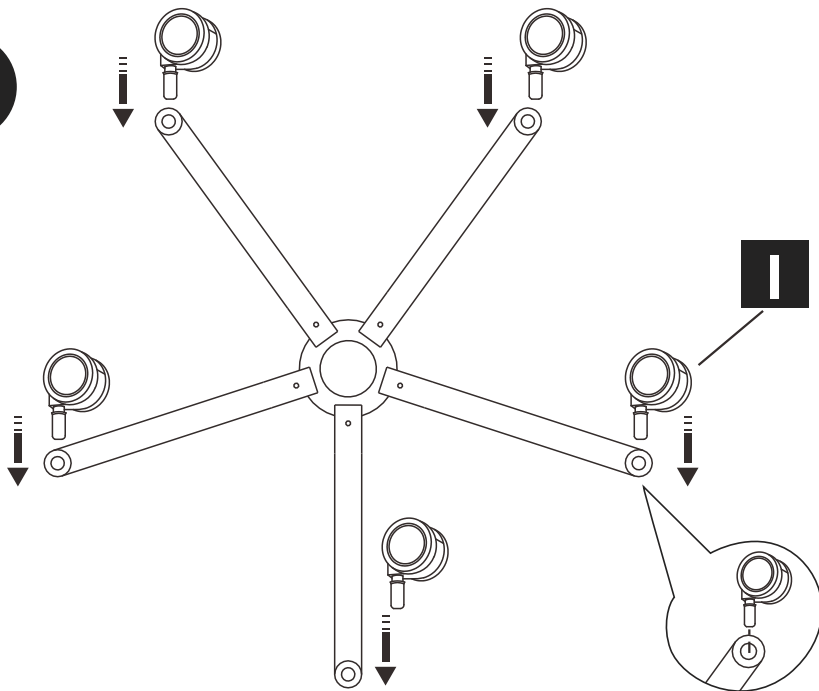

4

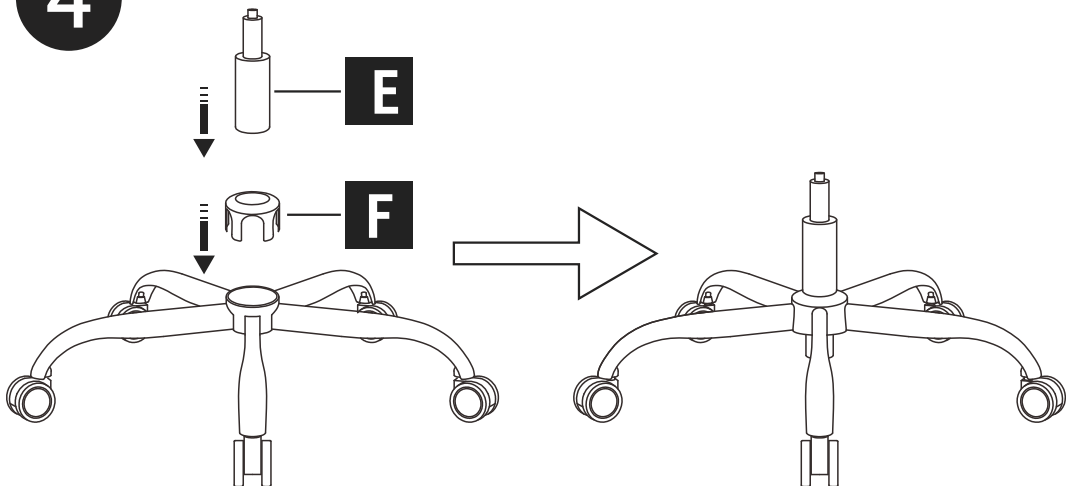

5

Attention:
All the screws in,
and then tighten them.

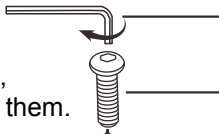

B

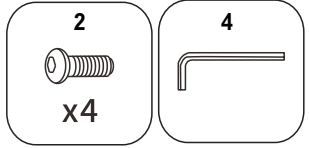
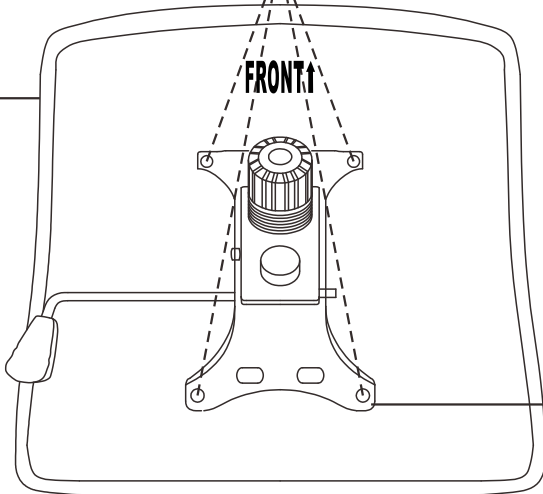

6

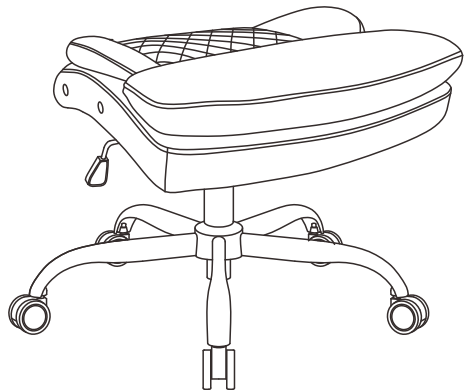
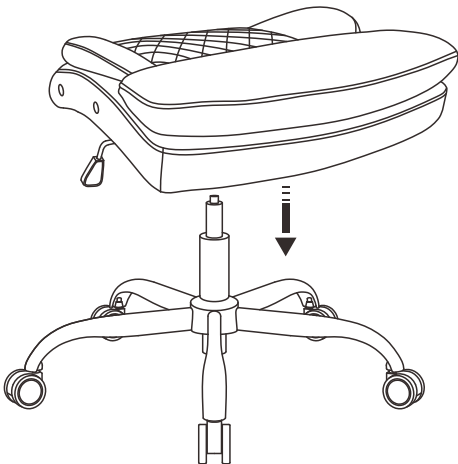

7

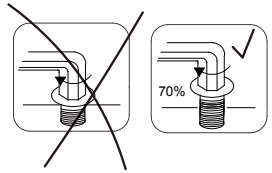
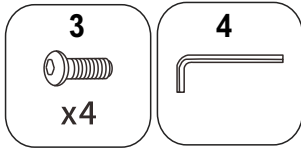

Please tighten the screws to 70%.

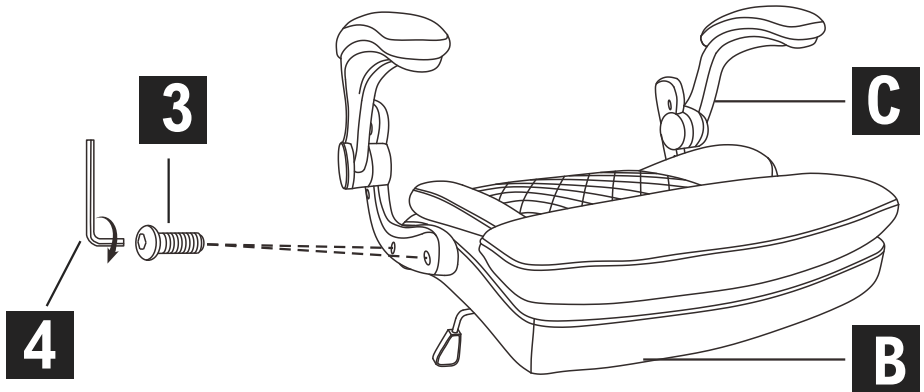

8

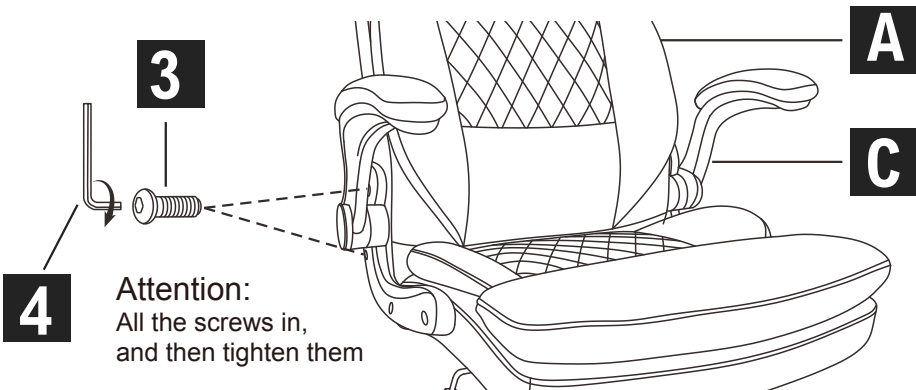
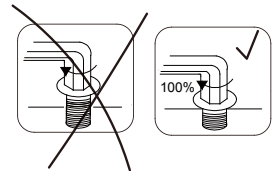
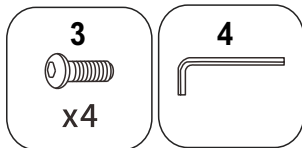

9



10

