

ASSEMBLY INSTRUCTIONS



4-PIECE CHAT SET WITH CUSHIONS*



**SCAN FOR ASSEMBLY VIDEO AND ONLINE
INSTRUCTION MANUAL**

This 4-piece chat set includes the following:

2 Club Chairs

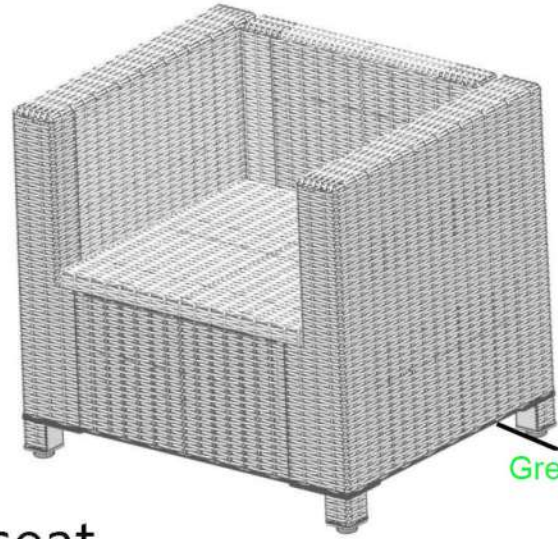
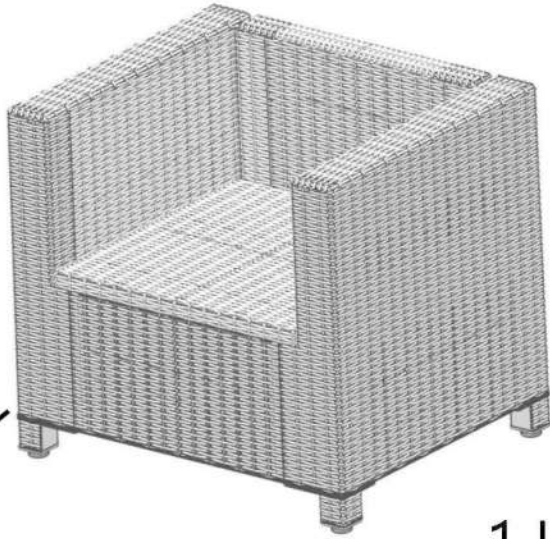

Green Bag

Green Bag

1 Loveseat

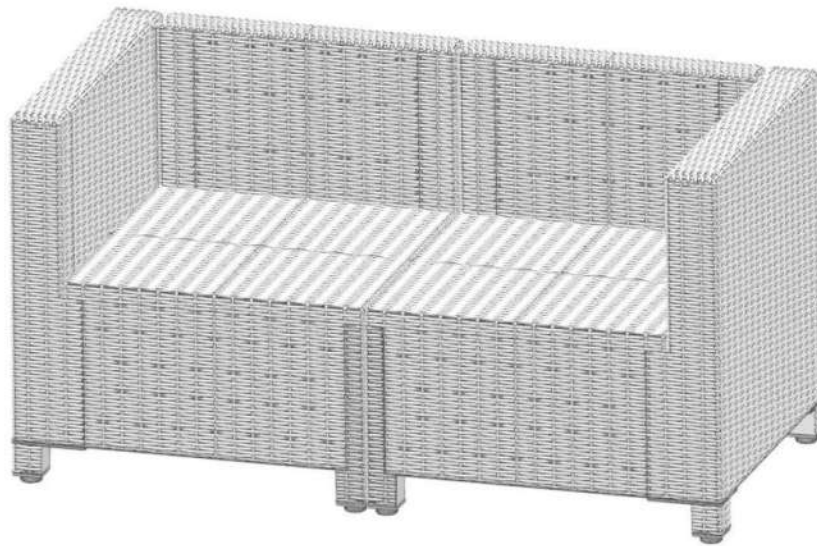

Red Bag

1 Rectangular Coffee Table







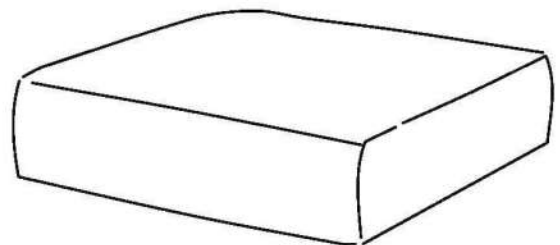

Yellow Bag

8 Cushions w/Covers

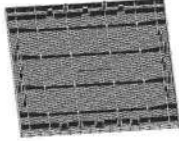
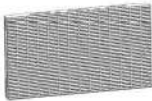

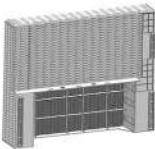
*Patent pending

CLUB CHAIR ASSEMBLY PARTS

PART	DESCRIPTION	IMAGE	QUANTITY
SB	Seat Board		1
FP	Front Panel		1
BP	Back Panel		1
LP	Left Arm Panel		1
RP	Right Arm Panel		1
FT-31	Foot		1
FT-32	Foot		1
FT-33	Foot		1
FT-34	Foot		1

ASSEMBLY

1

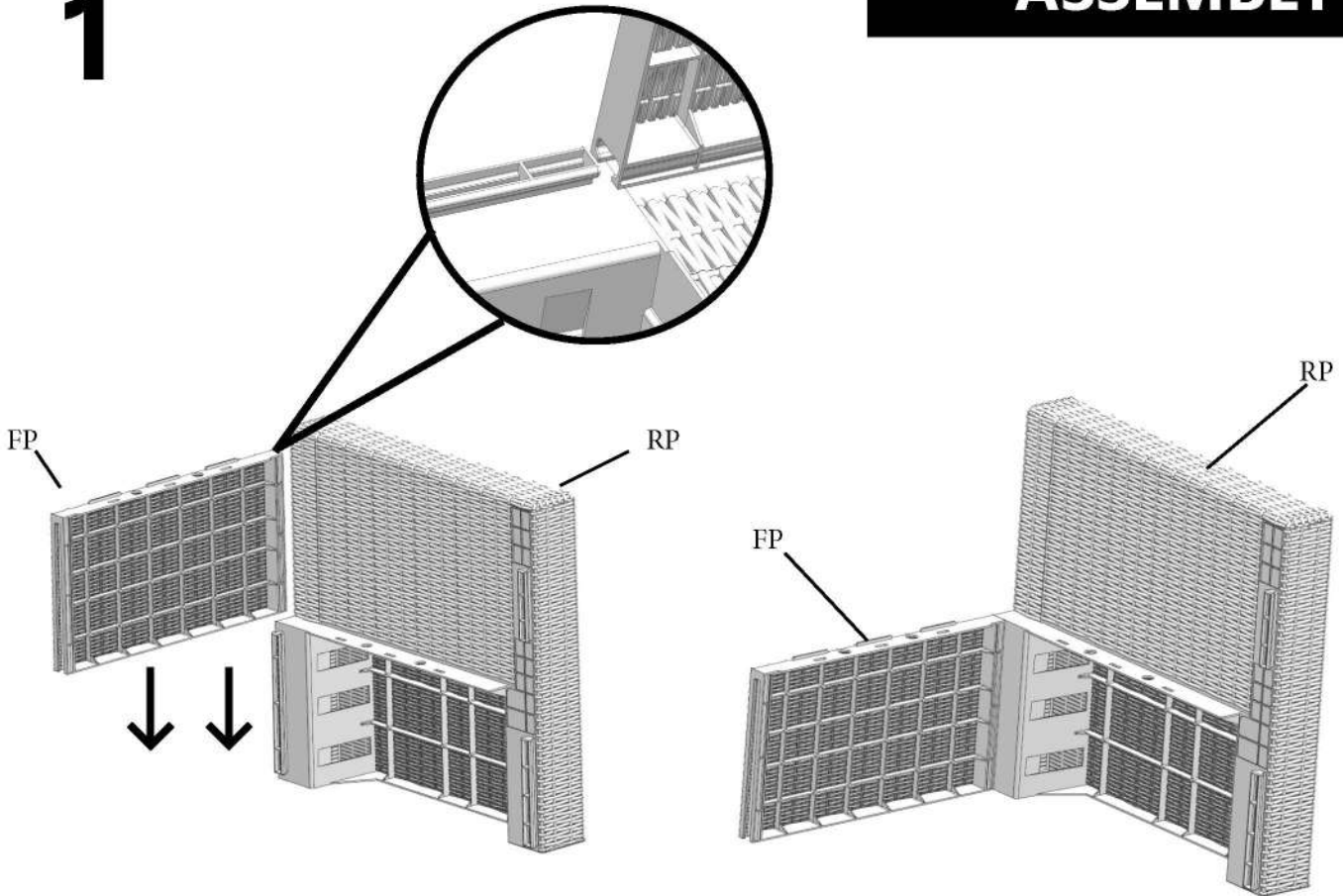

2

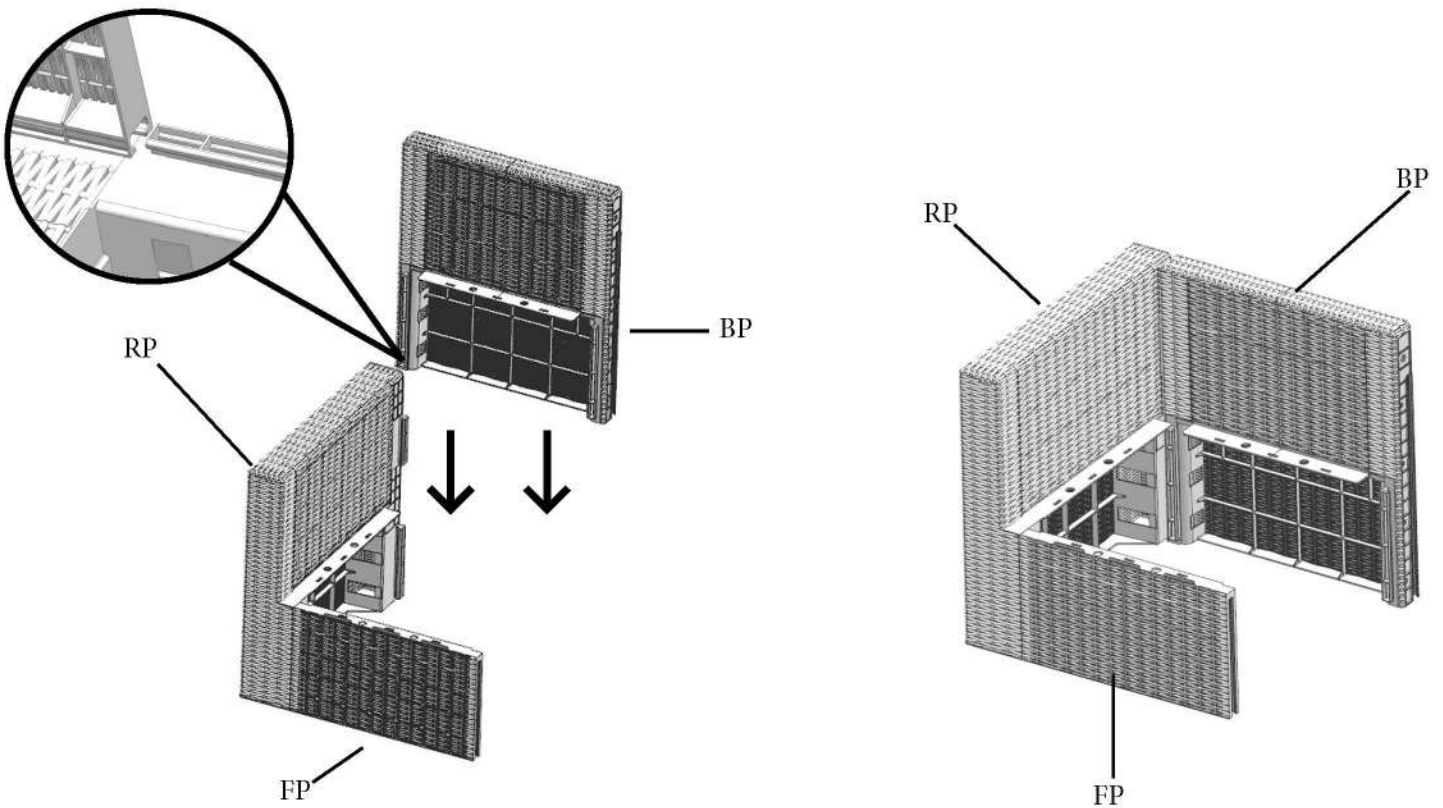

*Patent pending

3

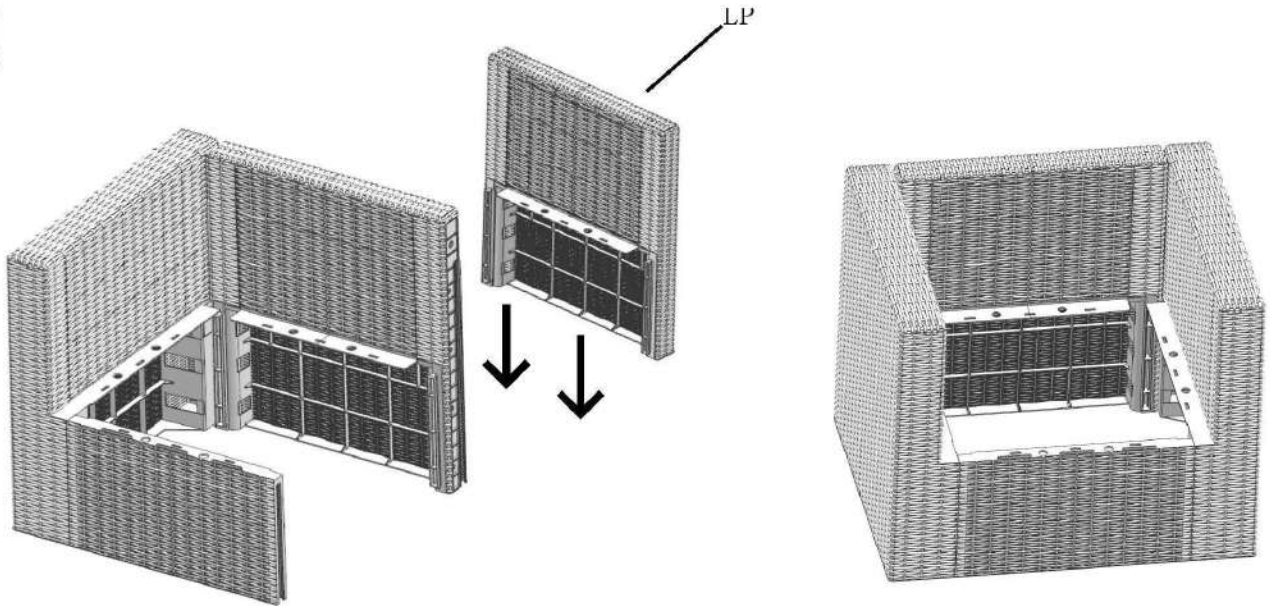

4

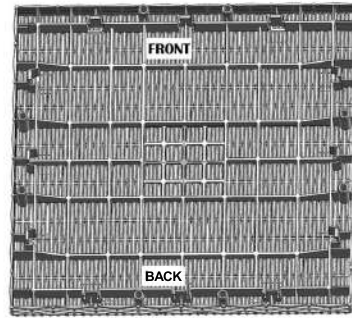
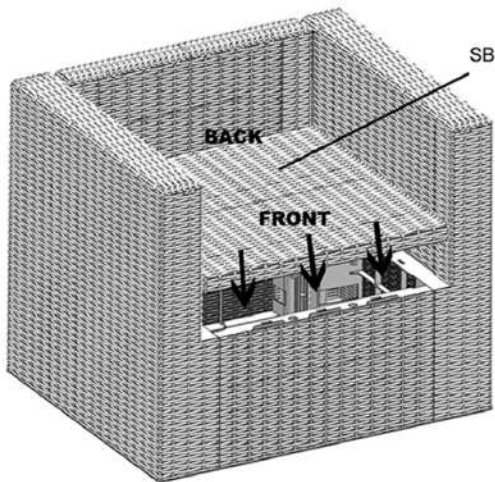

Caution!: Please assemble "Front" and "Back" as the pic shown. Incorrect assembly could result in damaging of product!

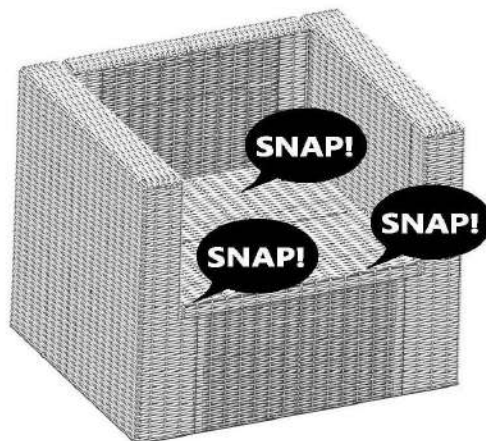

5

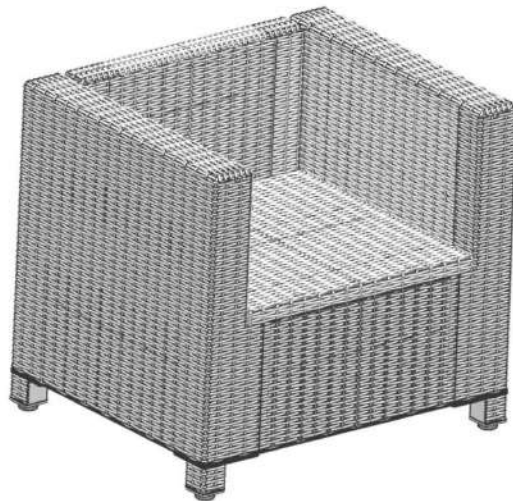
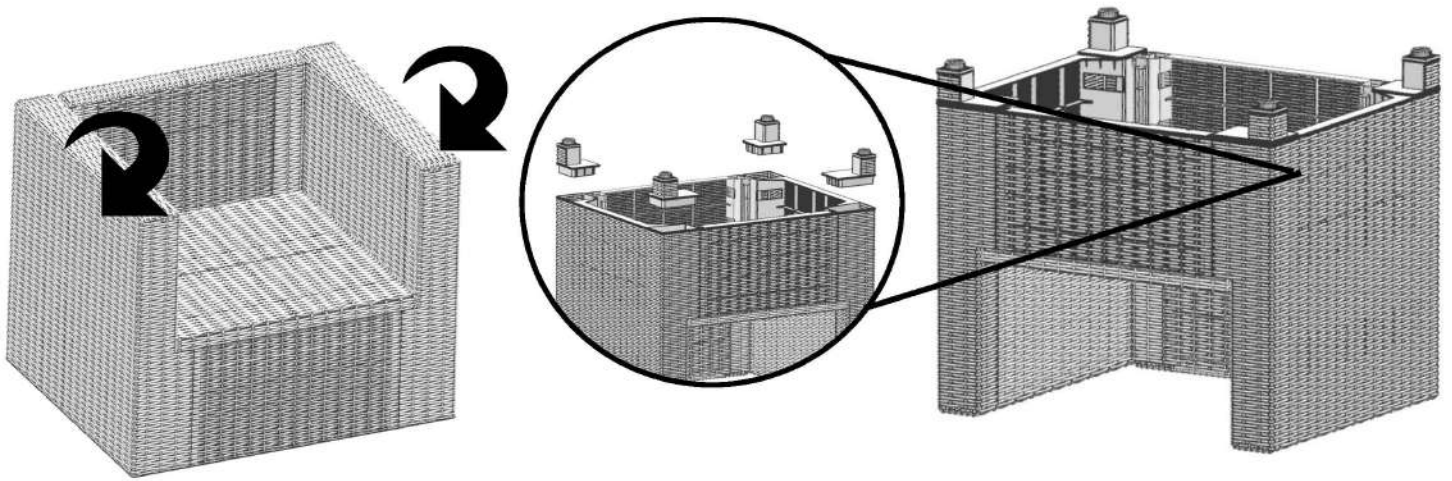

*Patent pending

6

1

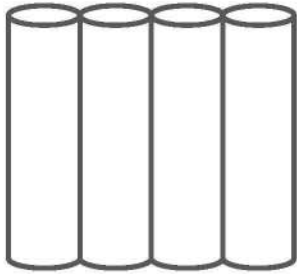

2

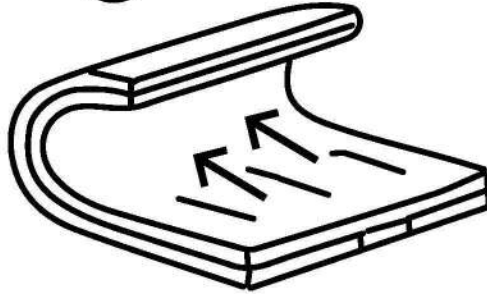

3

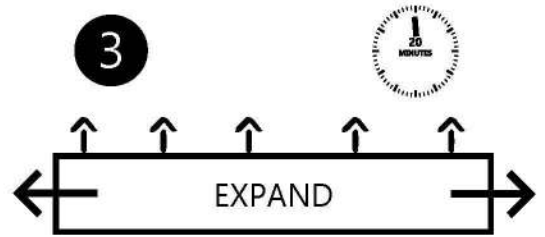

4

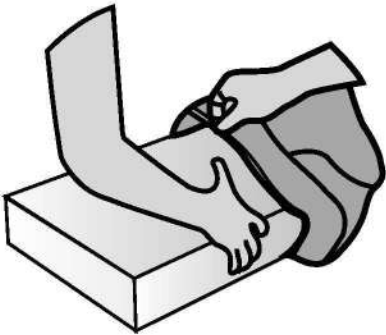





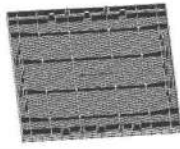
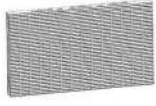

Please note that it may take up to 24 hours for the cushions to reach their final firmness.

Repeat steps 1-6 for to assemble your second club chair.

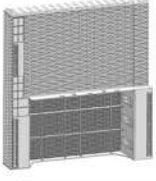
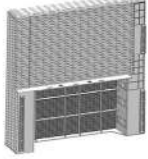

LOVESEAT ASSEMBLY PARTS

PART	DESCRIPTION	IMAGE	QUANTITY
SB	Seat Board		2
FP	Front Panel		2
BP	Back Panel		2
SP	Side Panel		2
LP	Left Arm Panel		1
RP	Right Arm Panel		1
FT-1/FT-2	Foot		2
FT-31/FT-32	Foot		2
FT-33/FT-34	Foot		2
CLIP	Clips		2

*Patent pending

Caution: The love seat is an assembly of Right arm chair, Left arm chair with Clips!

ASSEMBLY

Right Arm chair

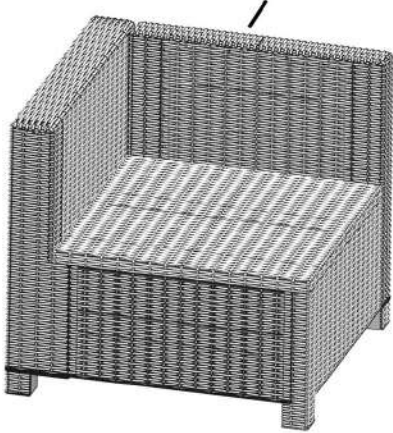

Left Arm Chair

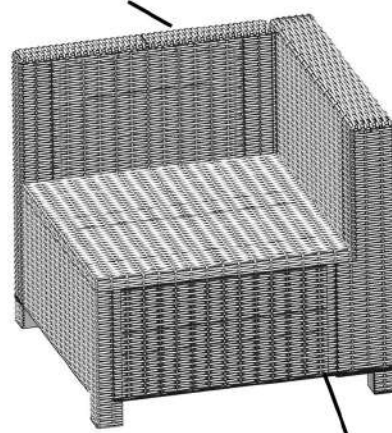

Refer Page 11 & 12 for assembly

1

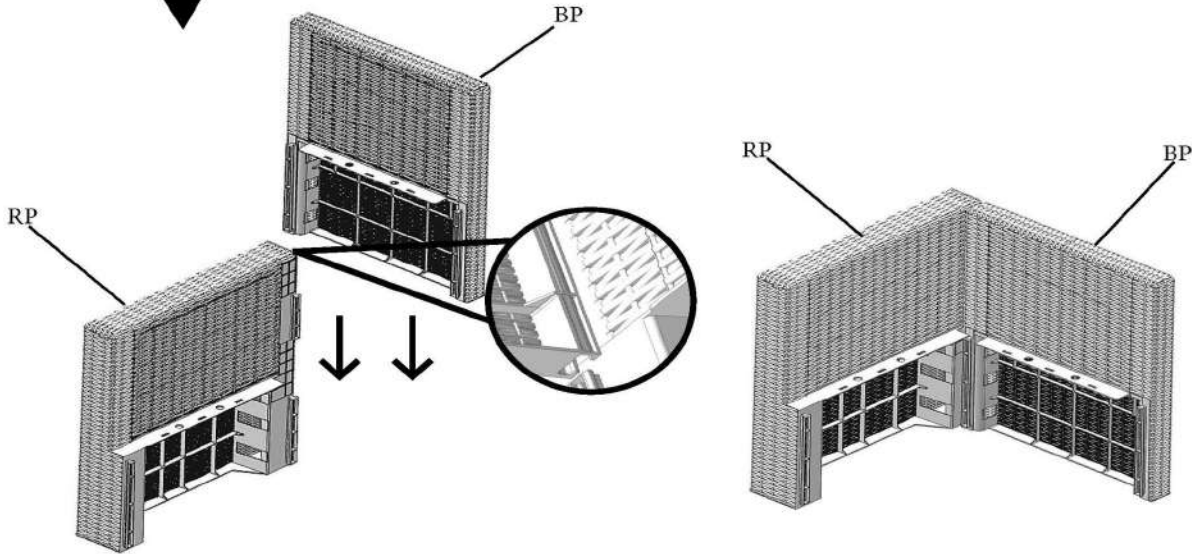
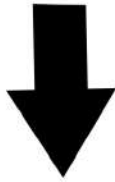

2

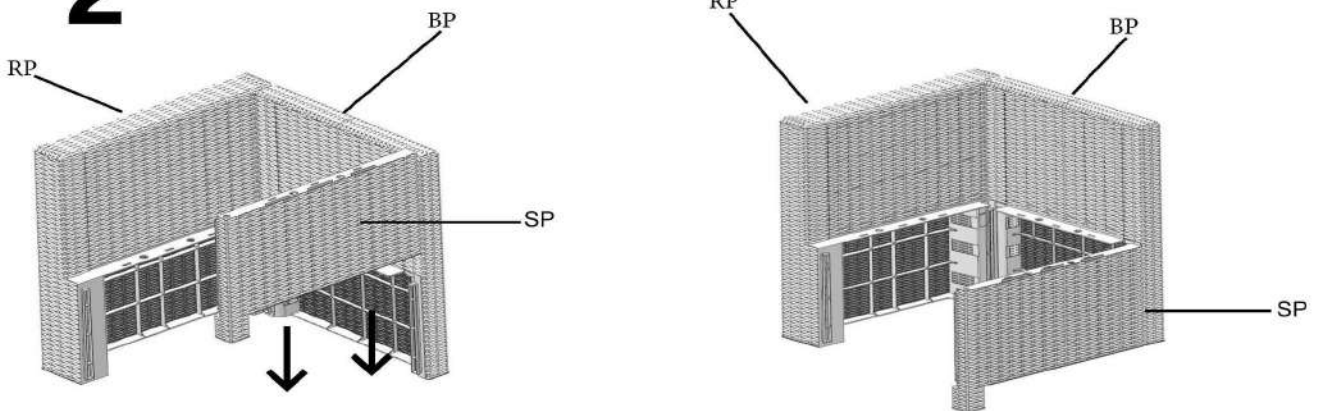

*Patent pending

3

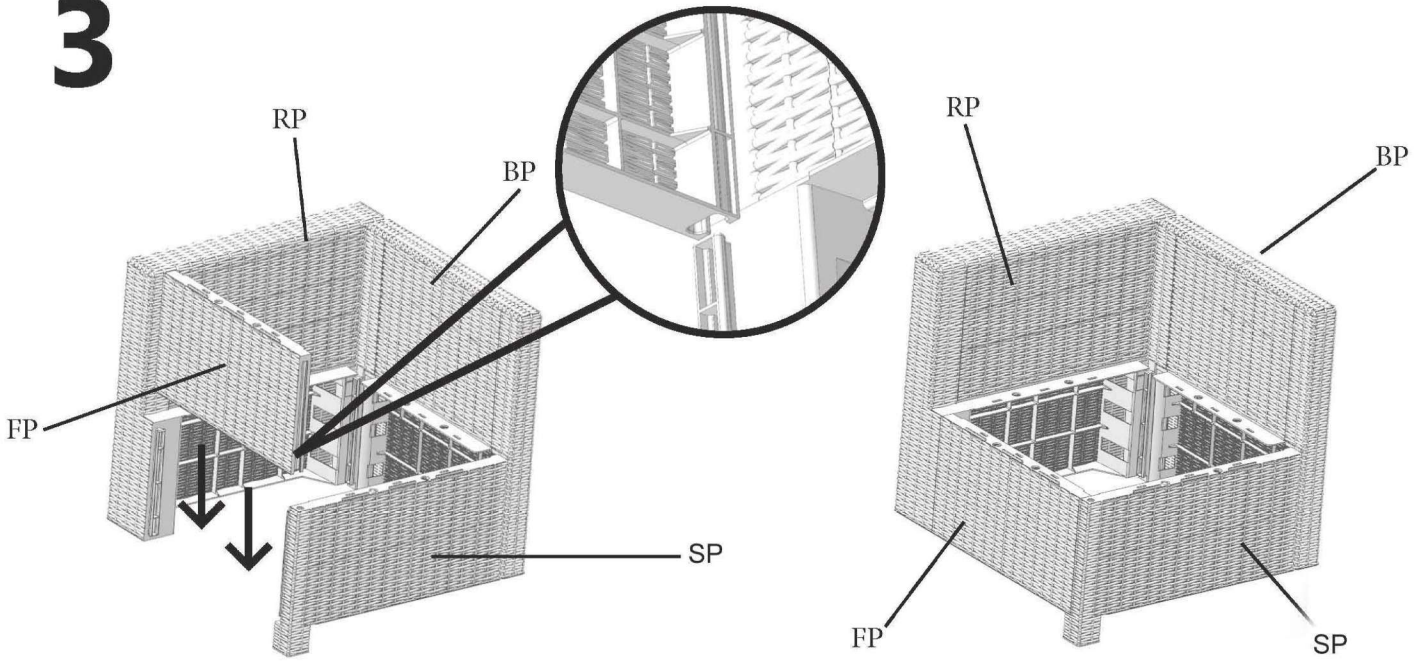

4

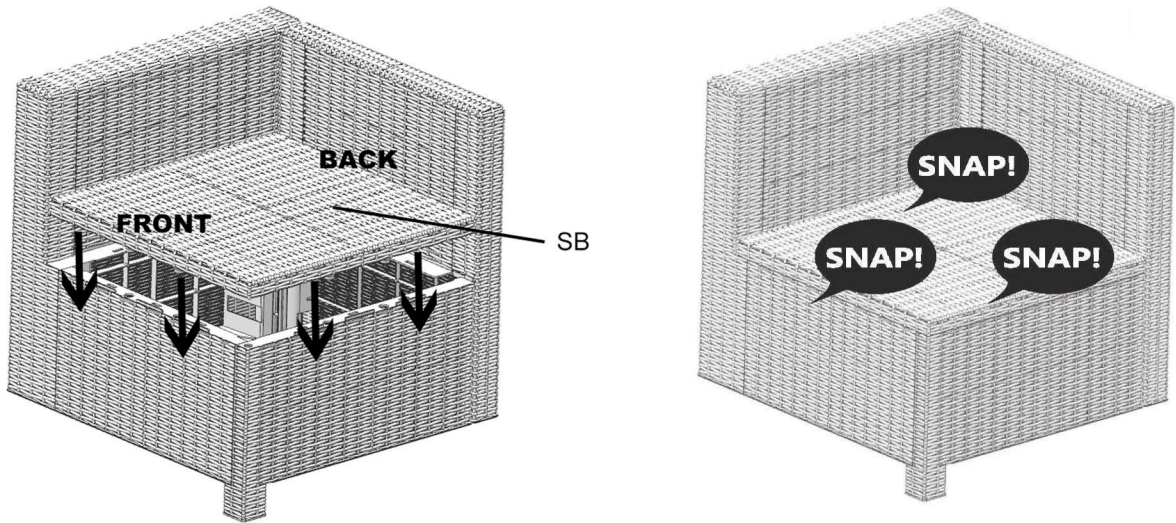

5

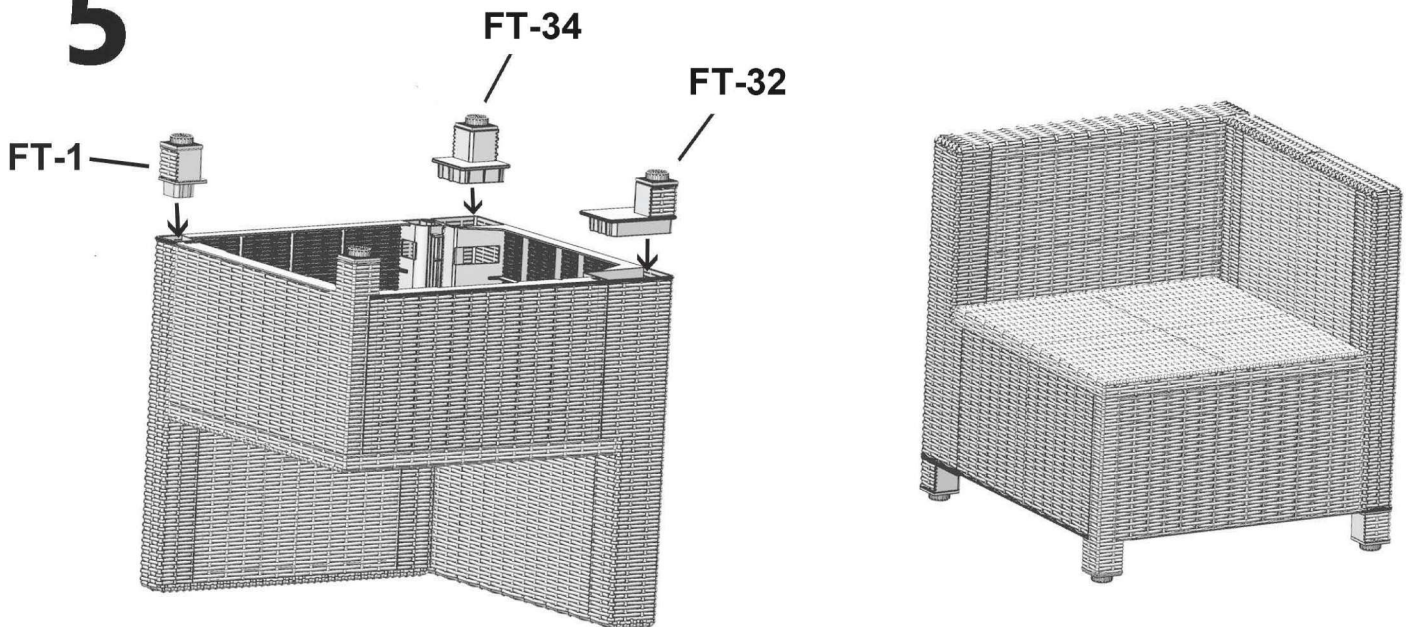

*Patent pending

6

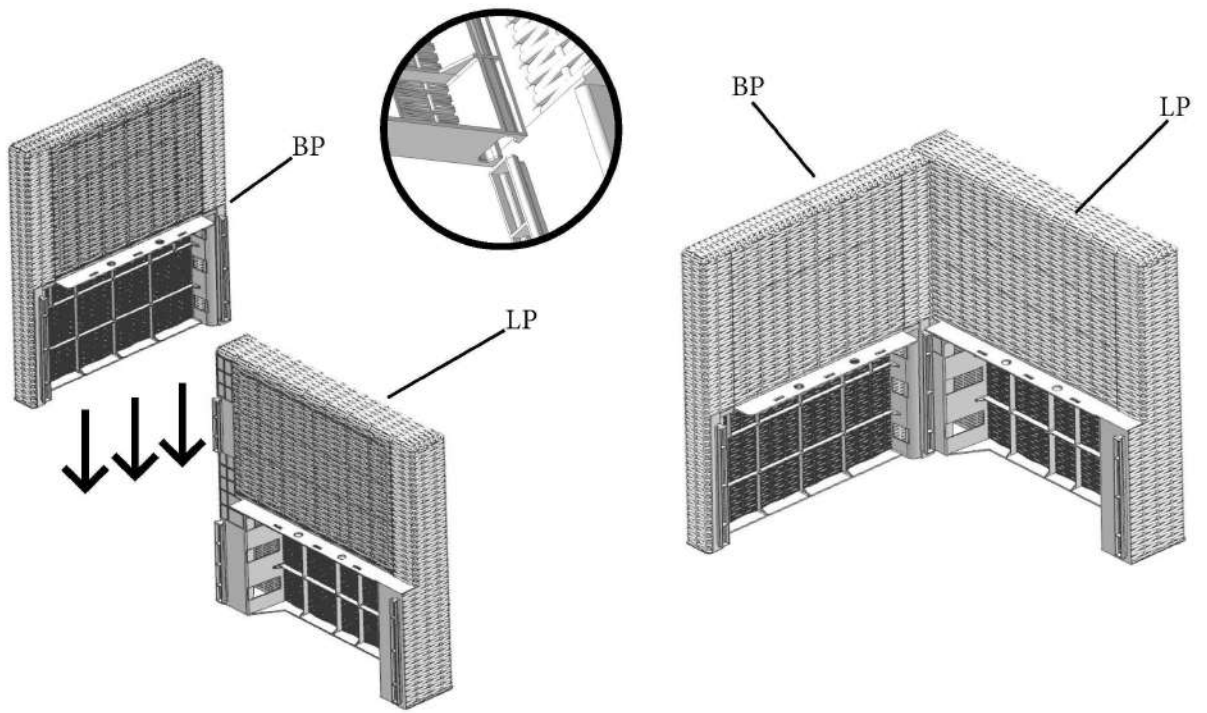

7

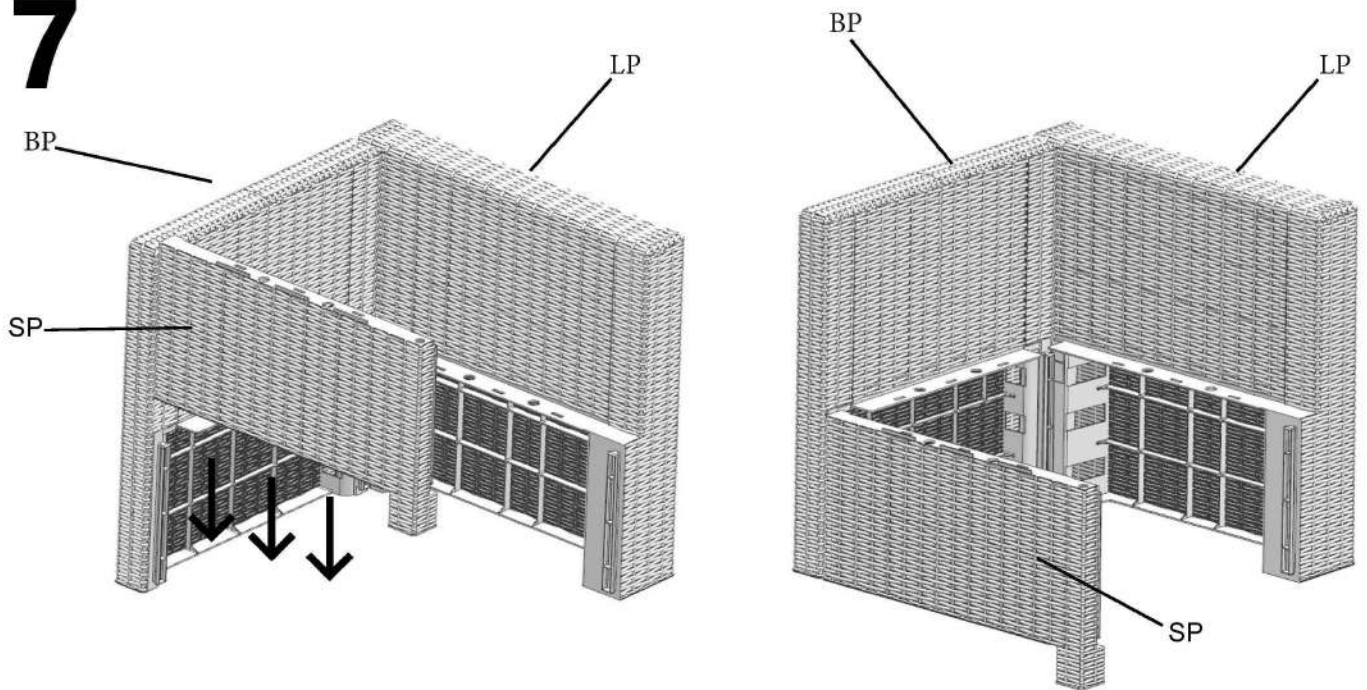

8

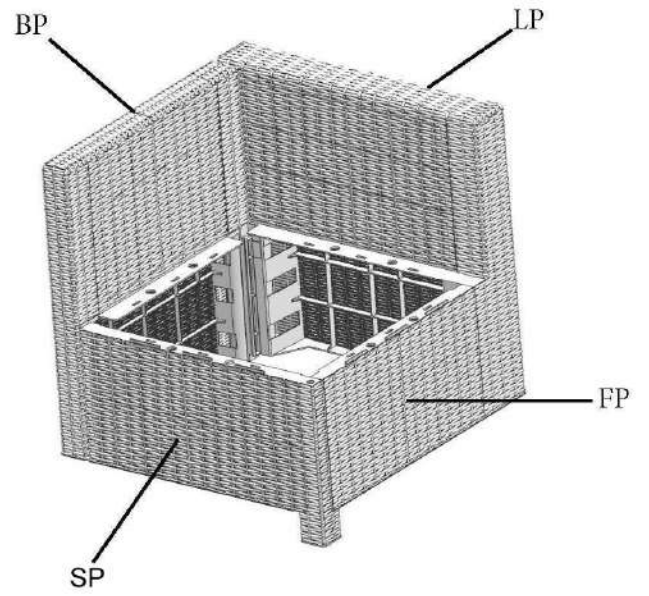
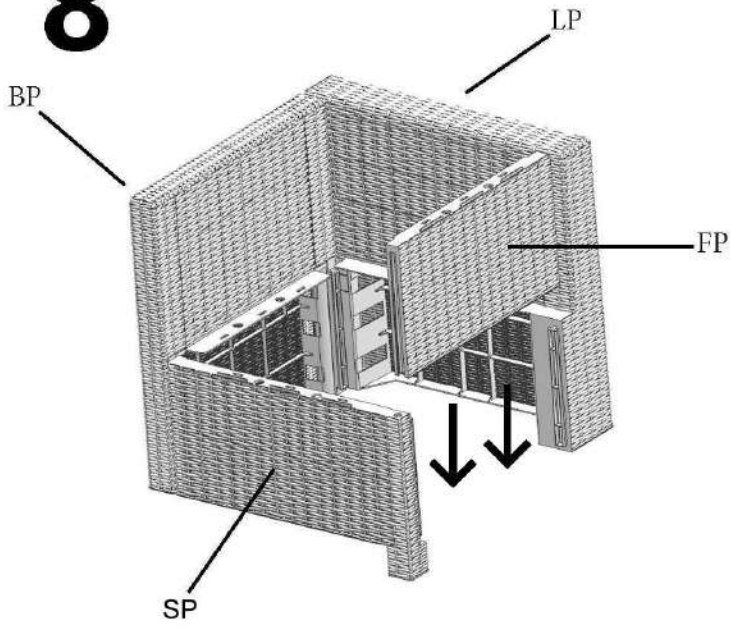

9

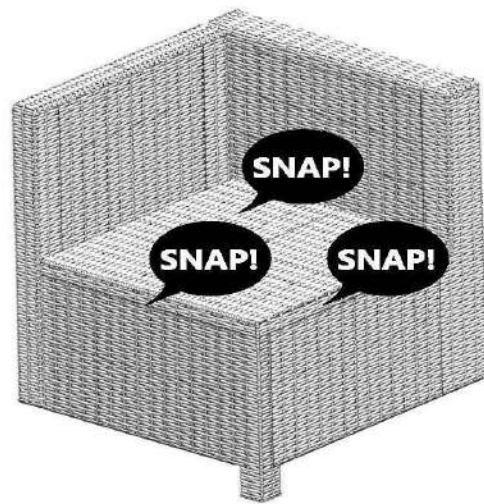
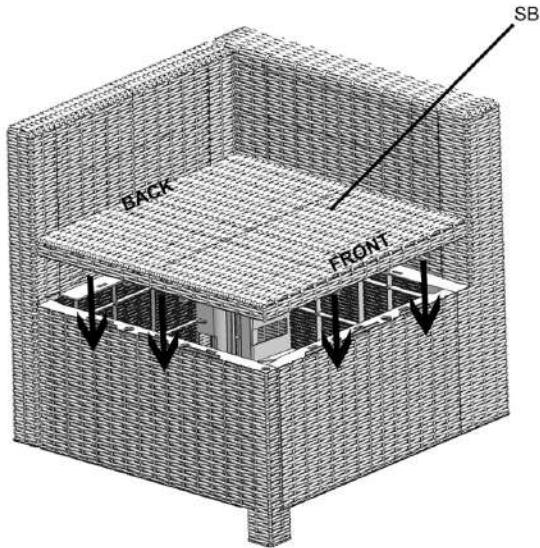

10

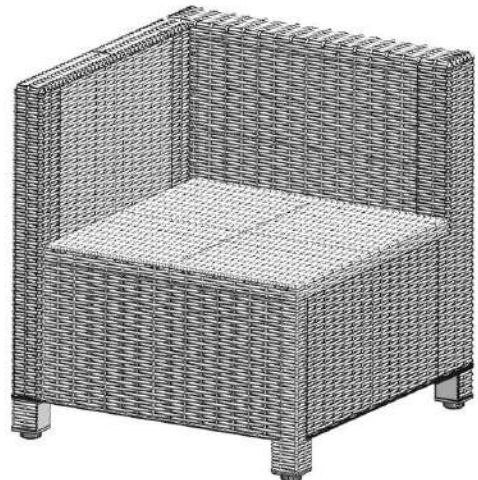
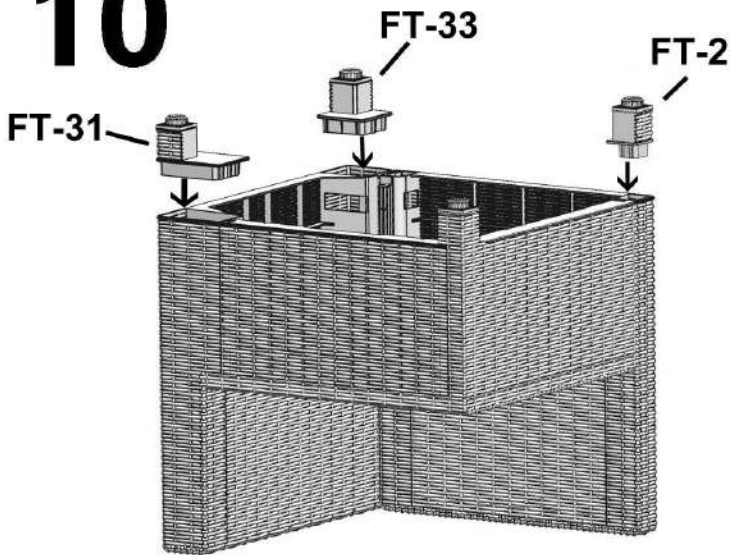

*Patent pending

11

⚠ CAUTION:

Before you assemble the clip, Please make sure you position the 2 chairs as shown below, Look at the Side Arm Rest to be wider than the back rest. If you don't follow this procedure, improper assembly could result in damaging the product.

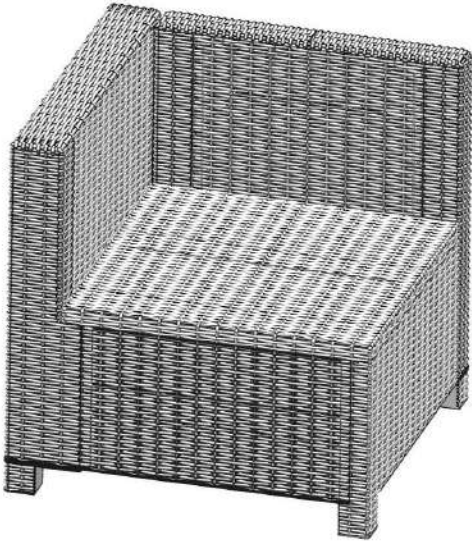

Right Arm Chair

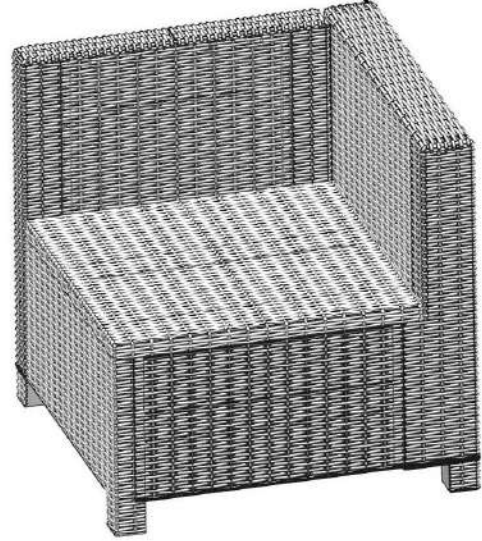

Left Arm Chair

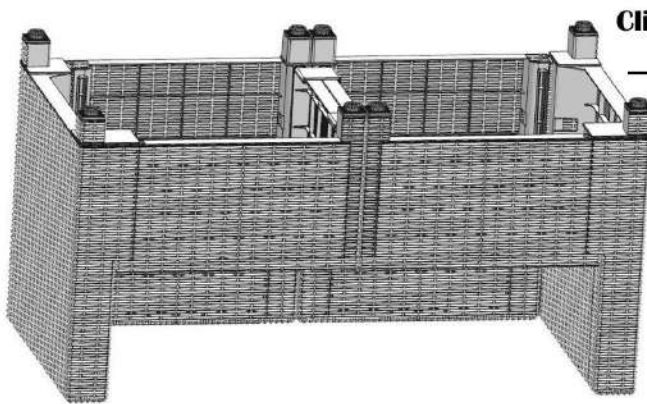

Clip assembly

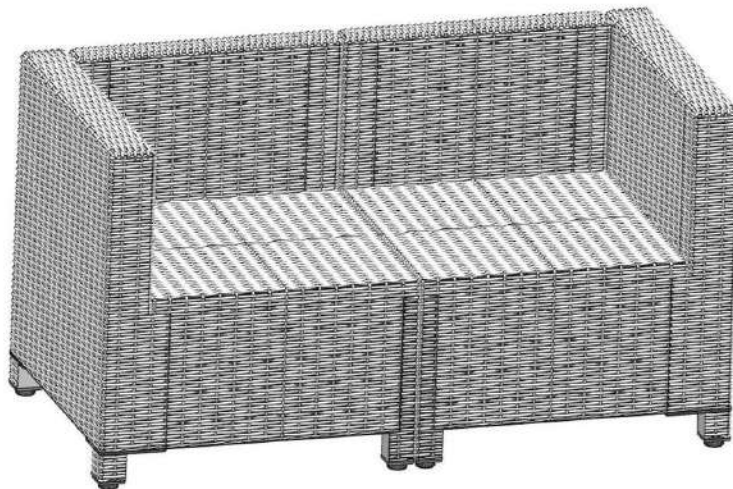
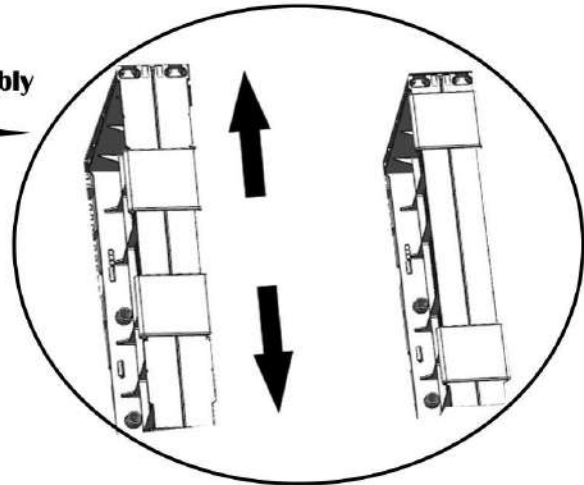

*Patent pending

12

1

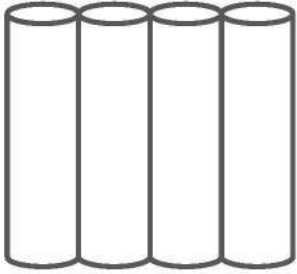

2

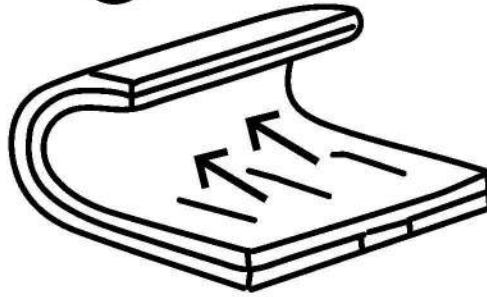

3

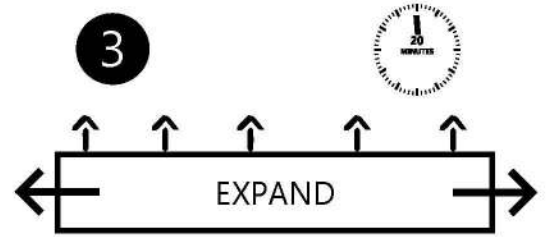

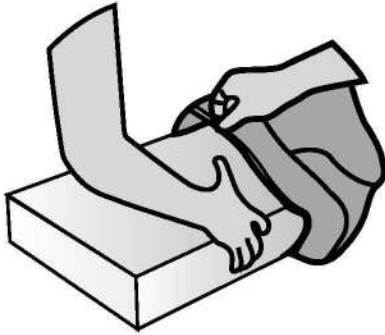

Please note that it may take up to 24 hours for the cushions to reach their final firmness.

4

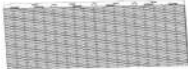

RECTANGULAR COFFEE TABLE ASSEMBLY PARTS

PART	DESCRIPTION	IMAGE	QUANTITY
RC-TT	Table Top		1
RC-LP	Long Side Panel		2
RC-SP	Short Side Panel		2
CTR-LG	Coffee Table Legs		4

ASSEMBLY

1

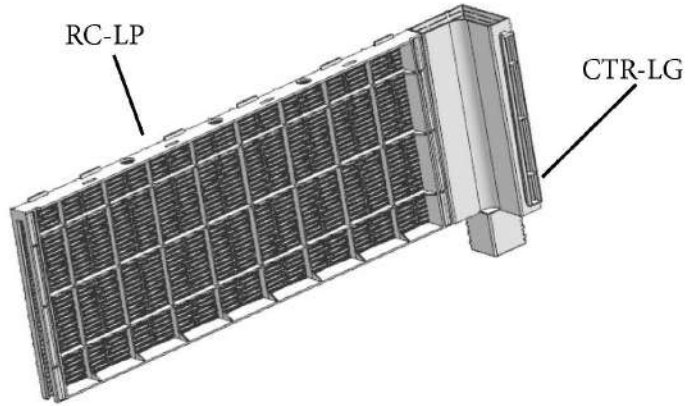
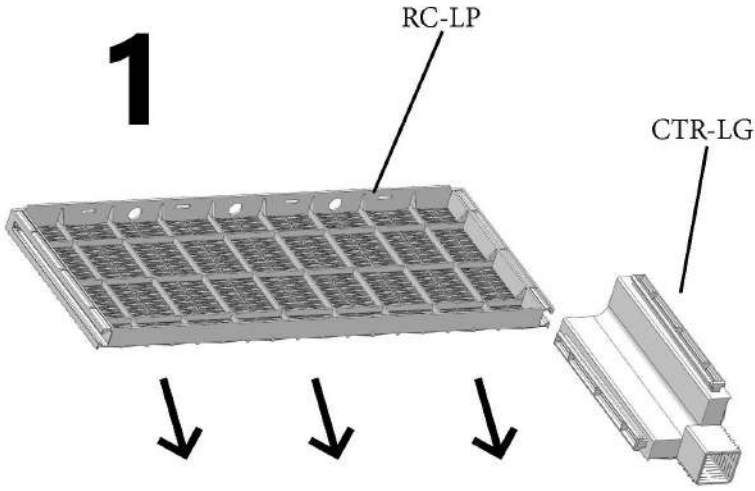

2

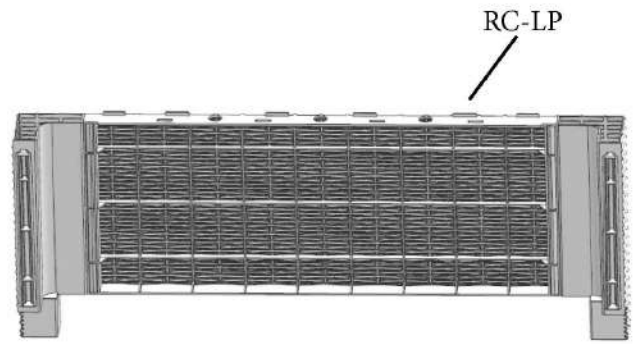
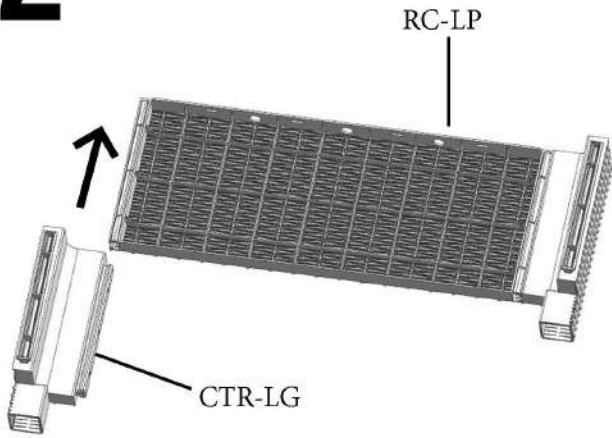

3

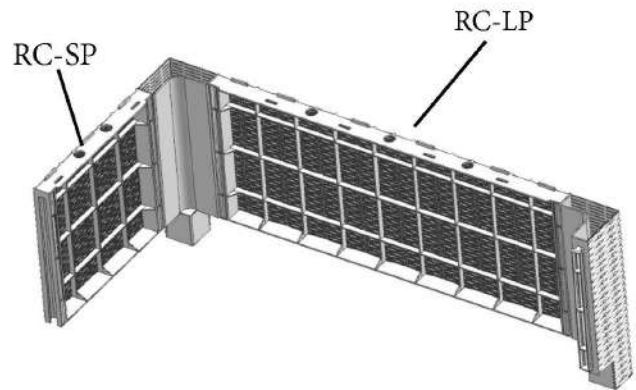
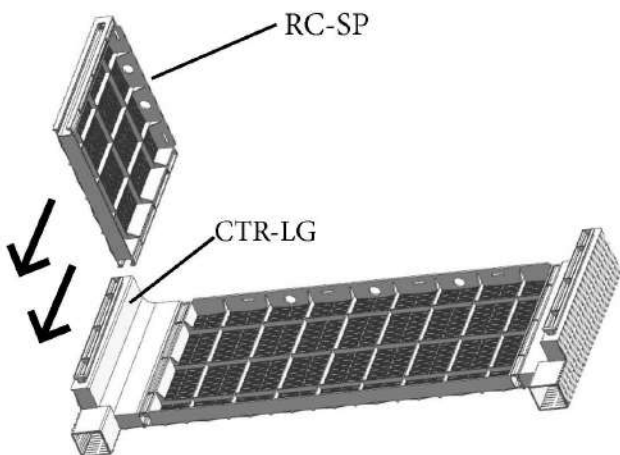

4

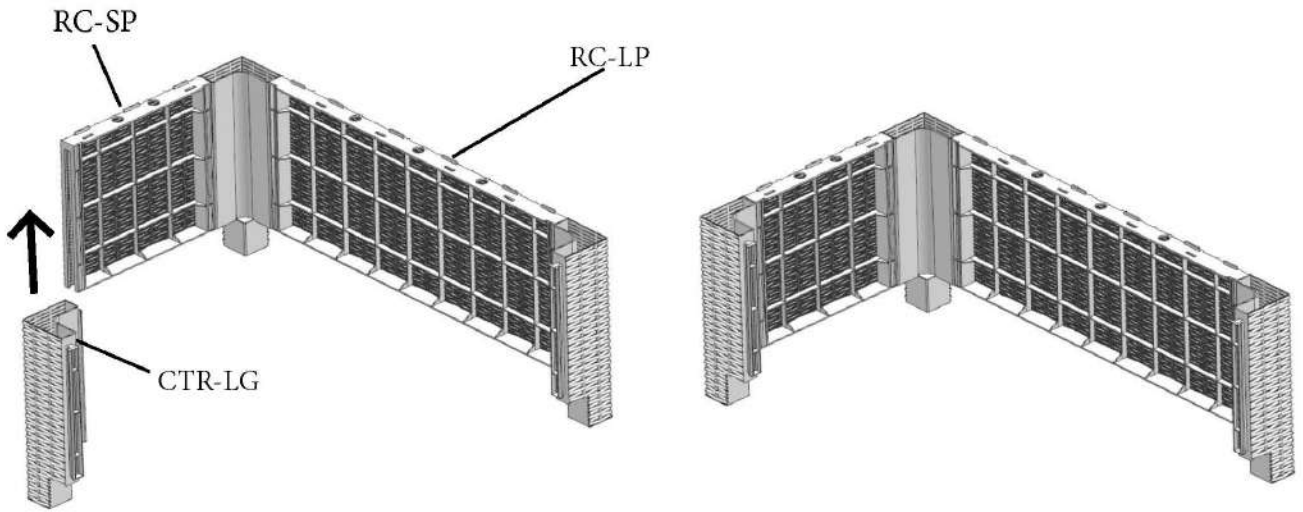

5

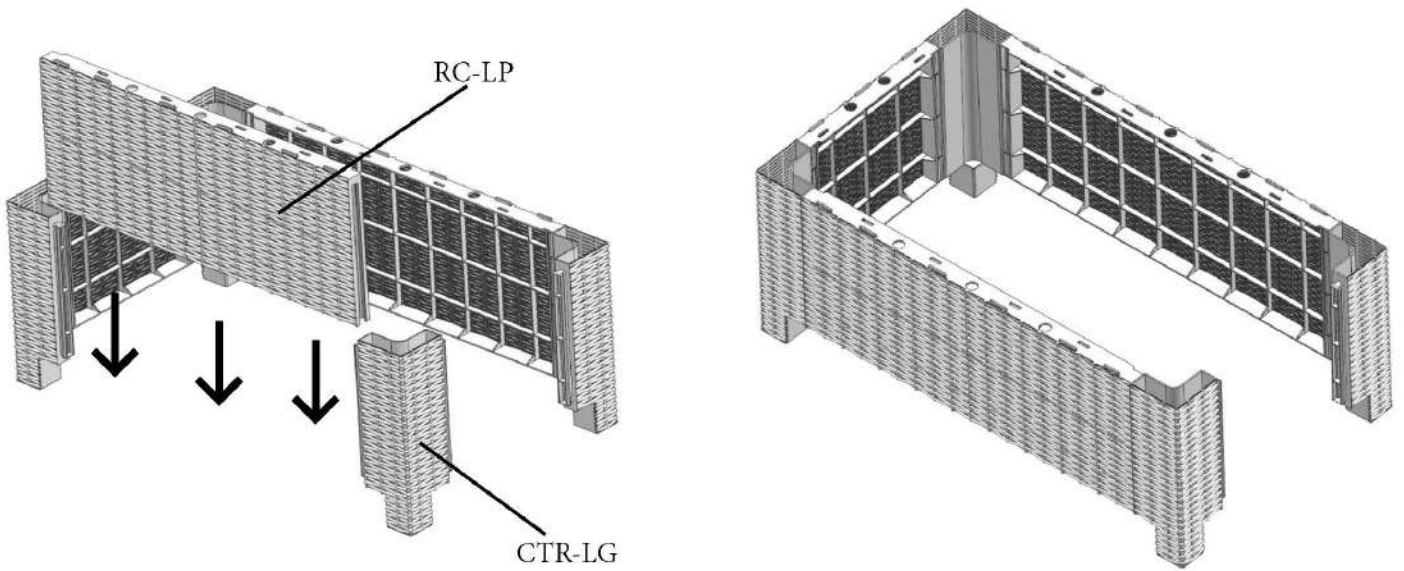

6

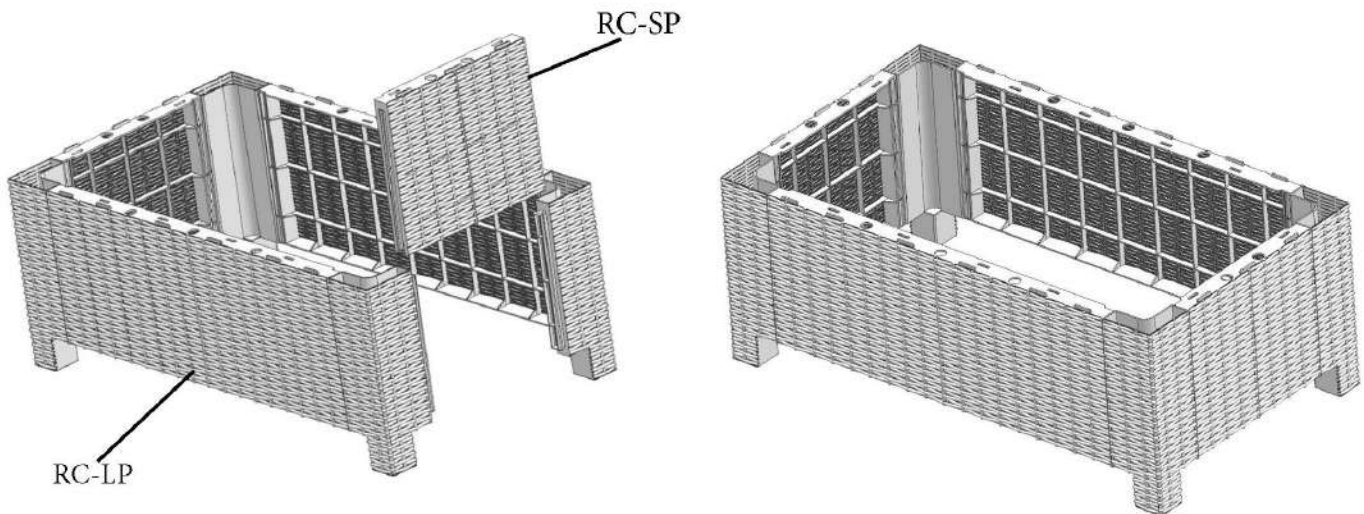

*Patent pending

7

RC-TT

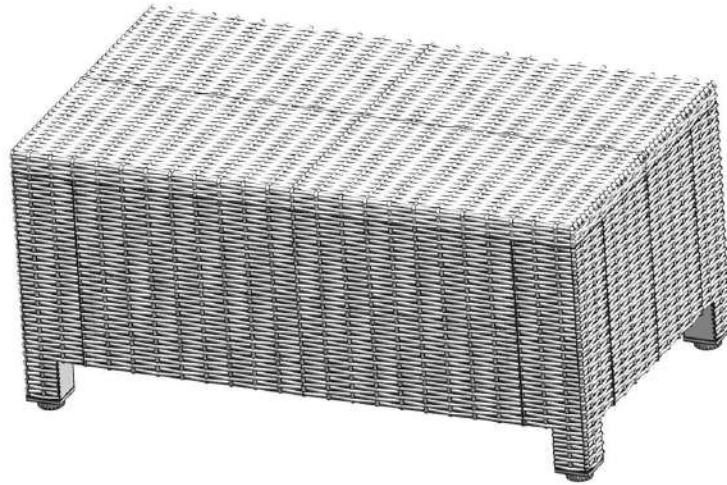
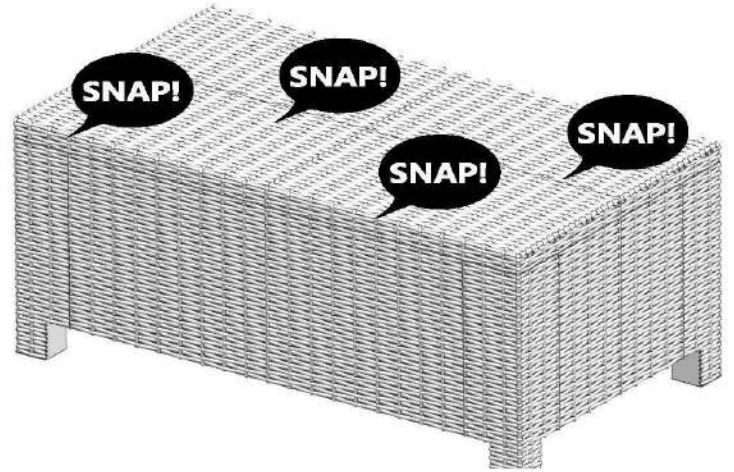
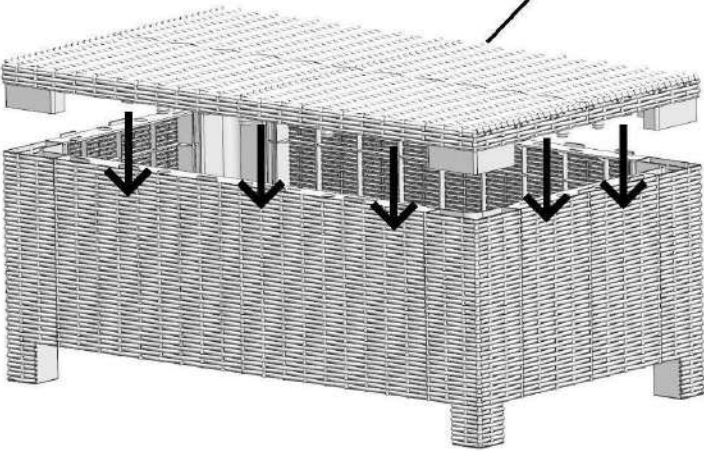

*Patent pending





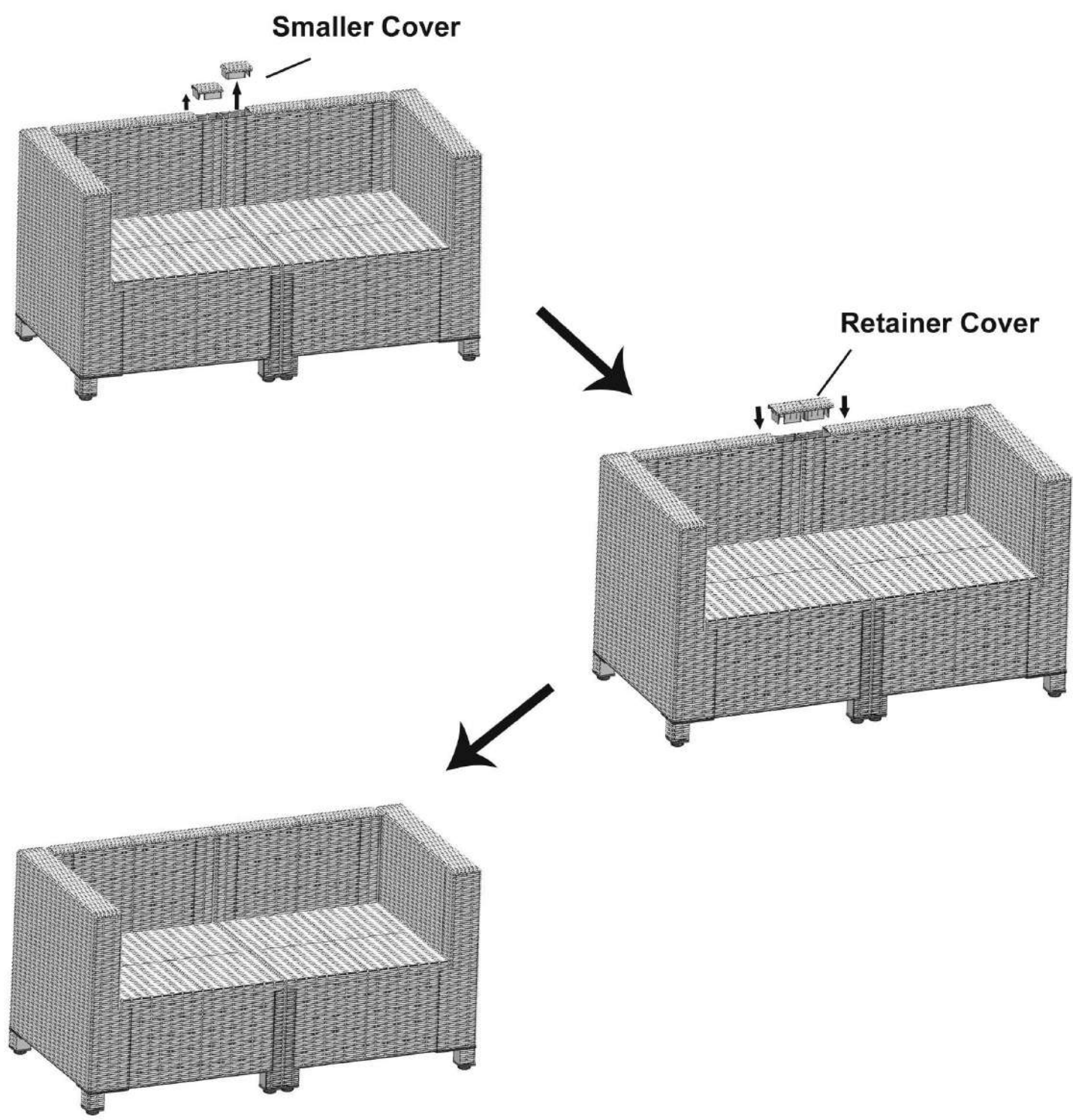





RETAINER COVER ASSEMBLY

In order to retain/combine 2 chairs together, please remove the small covers as shown and replace it with a "Retainer Cover"



*Patent pending

Care & Maintenance

- ⊘  ● Do not put hot items directly on furniture surface.
 - ⊘  ● Do not clean furniture with harsh cleansers or polish.
 - ✓  ● To obtain the longest lifespan of your outdoor products, minimizing exposure to direct sunlight is recommended.
 - ⊘  ● Children should not climb or jump on the furniture.
 - ⊘  ● Do not write on furniture without a padded barrier to protect the surface.
 - ✓  ● To obtain the longest lifespan of your outdoor products, avoid extended and lengthy exposure to rain, snow, and direct sunshine. Whenever possible cover the product and /or place under patio or awnings.
 - ⊘  ● Not for commercial use. For residential use only.
 - ⊘  ● Stains may be removed with mild soap solution and damp cloth.
 - ✓  ● Keep away from sources of ignition.
-
- ✓  ● Dust and pick-up spills using a clean, non-colored, lint-free cloth.