

## IMPORTANT SAFETY NOTICE: READ CAREFULLY BEFORE BEGINNING ASSEMBLY!



- \* Always use proper tools.
- \* Follow the assembly steps in order. Do not skip any steps.
- \* Be sure to check all packing materials carefully for small parts may have come loose inside the carton during shipment. If parts are missing, contact the retailer from which you purchased the product to obtain any missing parts. DO NOT USE SUBSTITUTE PARTS.
- \* Periodically check to ensure that all connectors (bolts, screws, etc.) are tight.
- \* Keep the instructions for future reference.
- \* Some assembly may involve attaching glass or mirrors. Be very careful handling the glass or mirrors, as severe injury may result if the glass or mirror breaks. Never handle large pieces of glass or mirrors by yourself.
- \* When assembling products that have electric cords (lamps, light, etc.), always (1) make sure the electrical cord is unplugged before assembly and (2) be careful not to twist the electrical cord during assembly.
- \* When assembling shelves or entertainment centers, do not stand on lower shelves in order to assemble upper shelves-use a step ladder.
- \* Do not stand on tables, including but not limited to, end tables, coffee tables, and dinner tables, as tables are not to support the weight of a person.
- \* Where assembly instructions state that the assembly requires two or more people, do not attempt by yourself as there is a risk of injury.



NOTE: DISCLAIMS ANY LIABILITY FOR DAMAGES OR INJURIES WHICH MAY OCCUR DUE TO FAILURE TO PROPERLY FOLLOW ASSEMBLY INSTRUCTIONS, PROPERLY ASSEMBLE THE PRODUCT, OR PROPERLY USE THE PRODUCT.

**NOTE: YOUR UNIT MAY LOOK DIFFERENT IN APPEARANCE FROM THE ONE SHOWN IN THE ILLUSTRATIONS ON THIS INSTRUCTION SHEET.**

## NOTICIA IMPORTANTE DE SEGURIDAD: LEA CUIDADOSAMENTE ANTES DE COMENZAR A ENSAMBLAR

- \* Siempre use las herramientas apropiadas.
- \* Siga los pasos de ensamble en orden. No salte ningún paso.
- \* Asegúrese de comprobar con cuidado todos los materiales de embalaje en busca de piezas pequeñas que hayan podido desprenderse dentro del cartón durante el envío. Revise la lista de partes. Si faltan partes, comuníquese con el surtidor del cual usted compró el producto para obtener las partes que le faltan. NO USE PARTES SUSTITUTAS.
- \* Periódicamente revise para asegurarse que todos los conectores (pernos, tornillos, etc.) estén bien apretados.
- \* Guarde las instrucciones para referencia futura.
- \* Algunos de los ensambles involucran vidrios o espejos. Tenga cuidado al manejar estos vidrios o espejos, ya que puede lesionarse severamente si uno de estos vidrios o espejos se rompe. Nunca maneje piezas grandes de vidrio o espejo sin ayuda.

- \* Al armar productos con cables eléctricos (lamps, lights, etc.), siempre (1) asegúrese que el cable este desenchufado antes de armar (2) tengacuidado de no doblar el cable al marmar.
- \* Al armar repisas o centros de entretenimiento, no se pare en las repisas de abajo para armar las repisas de arriba-use una escalera.
- \* No se pare en las mesas, incluyendo pero sin límite a, mesas laterales, mesas de centro, mesas de comedor, ya que estas mesas no esta'n. Construidas para soportar el peso de una persona.
- \* Si las instrucciones dicen que se debe usar dos o mas personas no trate de armado solo, ya que corre el riesgo de lastimarse.



NOTA: no se hace responsable for danos o lesiones que puedan ocurrir por no seguir las instrucciones de ensamblaje correctamente, el ensamble apropiado del producto, o el uso apropiado del mismo

**NOTA: LA UNIDAD PUEDE PRESENTAR UNA APARIENCIA DIFERENTE DE LA QUE SE MUESTRA EN LAS ILUSTRACIONES DE LA HOJA DE INSTRUCCIONES.**

## REMARQUE IMPORTANTE CONCERNANT LA SECURITÉ: LIRE ATTENTIVEMENT AVANT DE COMMENCER LE MONTAGE!

- \* Utilisez toujours les outils adaptés.
- \* Suivez l'ordre des étapes de montage. N'en sautez aucune.
- \* Assurez-vous de vérifier attentivement tous les matériaux d'emballage parce que les petites pièces peuvent se détacher à l'intérieur de la boîte lors de l'expédition. Faites l'inventaire attentif de toutes les pièces. Si une ou plusieurs pièces manquent, contactez votre revendeur pour obtenir les pièces en question. N'UTILISEZ PAS DE PIÈCES DE SUBSTITUTION.
- \* Vérifiez de temps à autre que tous les connecteurs (boulons, vis, etc.) sont bien serrés.
- \* Gardez ces instructions pour pouvoir les consulter ultérieurement.
- \* Certaines étapes du montage peuvent nécessiter l'installation de verres ou de miroirs. Soyez extrêmement prudent lors de la manipulation des verres ou des miroirs, car vous pourriez vous blesser gravement si le verre venait à casser. Ne manipulez jamais seul de grands objets en verre ou de grands miroirs.

- \* Lors de l'assemblage des produits qui comportent des fils électriques (lampes, lumières, etc.), assurez-vous toujours (1) que le câble électrique est débranché avant de procéder au montage et (2) faites attention à ne pas secouer le câble électrique pendant le montage.
- \* Lors du montage des étagères ou un meuble audio-vidéo, ne vous tenez pas sur les étagères inférieures pour installer les étagères supérieures. Utilisez un escabeau.
- \* Ne vous tenez pas sur les tables, ce qui comprend mais pas uniquement, les tables d'extrémité, les tables basses, les tables à dîner, car elles ne sont pas destinées à supporter le poids des personnes.
- \* Lors que les instructions de montage mentionnent que l'installation nécessite deux personnes ou plus, n'essayez pas de monter vous-même le produit, car vous risqueriez de vous blesser.



REMARQUE: NE SE TIEN T AUCUNEMENT REPO NSABLE DE TOUT DOMMAGES OU BLESSURES DUS AU NON RESPECT DES INSTRUCTIONS DE MONTAGE ET D'UTILISATION DU PRODUIT.

**REMARQUE: VOTRE MEUBLE PEUT ETRE DIFFERENT DE CELUI MONTRE SUR L'ILLUSTRATION DE CETTE FEUILLE D'INSTRUCTIONS.**

## 重要安全提示：组装家具前请仔细阅读以下指南！

- \* 请使用合适的工具进行组装。
- \* 按照组装步骤逐步完成，请勿跳过任一步骤。
- \* 由于小的零部件有可能在运输过程中散落于包装箱内，请仔细检查包装材料。如若发现部件丢失，请及时联系当地零售商以获取丢失部件。请勿用其它零部件替代。
- \* 定期检查以确保所有连接处（螺丝、螺帽等）均已拧紧。
- \* 请妥善保存该安装说明，以备将来需要时参考。
- \* 当产品中用到玻璃和镜子，安装时请小心操作，以防玻璃或镜子破碎造成伤害。请勿独自安装大块玻璃或者镜子。

- \* 对于附有电线的产品（台灯、立灯等），安装时请确保以下两点：
  1. 安装之前确保电源断开。
  2. 安装过程中请勿扭曲电线。
- \* 安装隔板或者电视柜时，请勿站在低层隔板上安装上层隔板，使用梯子进行安装。
- \* 请勿站立在茶几、边几或者餐桌之类的桌子上，这些桌子不能够支撑人体重量。
- \* 组装说明中一旦提及某一安装需要两到多人完成，请不要尝试独自安装，这样可能会对您人身安全构成威胁。











注意：对于未能严格按照组装说明书组装，未能正确组装产品，或者未能正确使用产品而造成的损失或伤害，将不负法律责任。

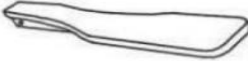
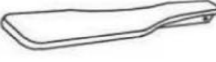

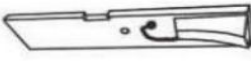

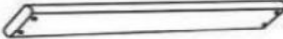

**注意：您所购买的产品与该组装说明书中配图在外观上可能会有差异。**

# Assembly Instructions

## CHAIR PARTS LIST:

<b>A</b>	<b>SEAT</b>		<b>1PC</b>
<b>B</b>	<b>BACKREST</b>		<b>1PC</b>
<b>C</b>	<b>ARMREST - LEFT</b>		<b>1PC</b>
<b>D</b>	<b>ARMREST - RIGHT</b>		<b>1PC</b>
<b>E</b>	<b>FRONT LEG - LEFT</b>		<b>1PC</b>
<b>F</b>	<b>FRONT LEG - RIGHT</b>		<b>1PC</b>
<b>G</b>	<b>FRONT BRACE</b>		<b>1PC</b>
<b>H</b>	<b>SEAT BRACE</b>		<b>1PC</b>
<b>I</b>	<b>GLIDER</b>		<b>2PCS</b>

## HARDWARE PARTS LIST

NO.	DESC.	PICTURES	QTY
1	1.6" SCREW		4PCS
2	2.6" CARRIAGE BOLT		4PCS
3	1.97" CARRIAGE BOLT		4PCS
4	1.6" BOLT		2PCS
5	3.3" CARRIAGE BOLT		2PCS
6	LOCK NUT		10PCS
7	WASHER		10PCS
8	ALLEN KEY, WRENCH, PHILLIPS HEAD SCREWDRIVER		1SET

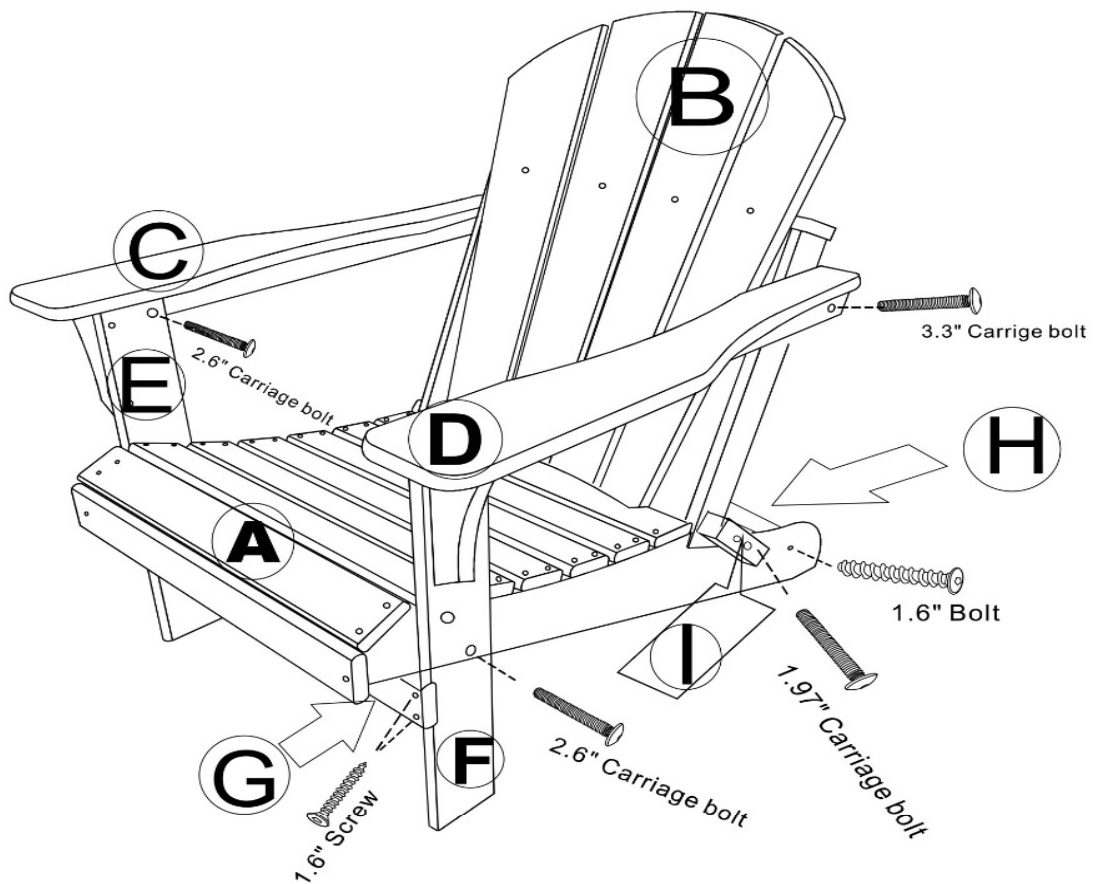

## STEP 1

Attach leg to seat using 2.6" carriage bolt, Install washer then nut.  
 Attach armrest to leg using 2.6" carriage bolt, Install washer then nut.  
 Do not overtighten. Repeat for other side.  
 Insert the stainless steel pins("A"), Pins can be removed for folding, Pull  
 out the pins when need to fold the chair.

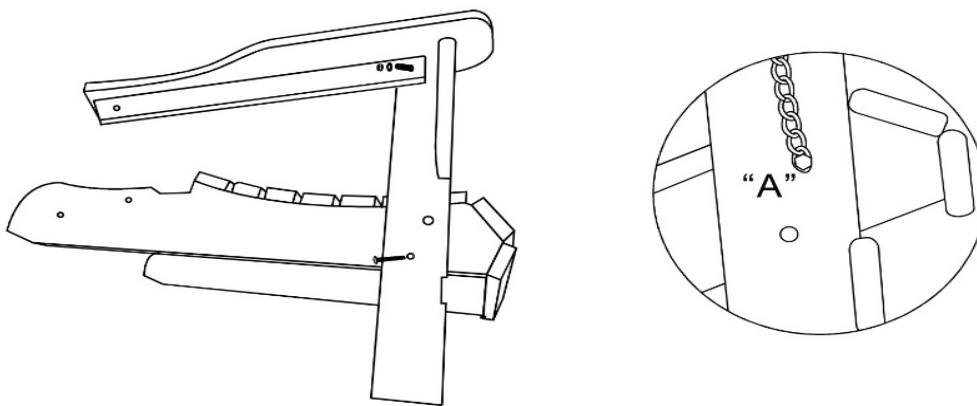

## STEP 2

Attach the glider piece to seat using 2.6" carriage bolt, Install washer then nut, Do not overtighten it. Attach brace between the seat using 1.6" bolt.

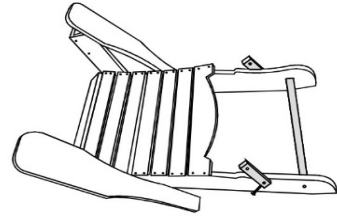

## STEP 3

Hold the backrest in place and install 1.97" carriage bolt through pivot "A". Raise arm rest into position and install bolt into predrilled holes. Be sure to line up the pre drilled holes in the backrest and armrest assembly. "B" install 3.3" carriage bolt. Repeat for other side. Then install washer and nuts. Do not over tighten.

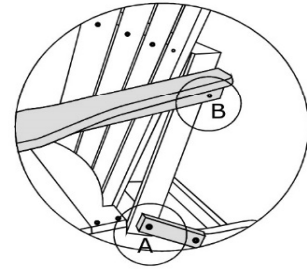

## STEP 4

Install the front brace, Then install 1.6" screw using the Phillips screwdriver to fasten.

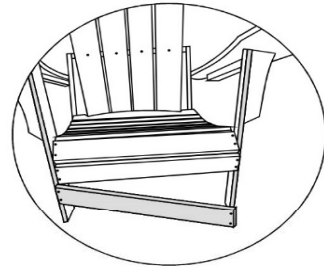

**Final product folds up for storage.**

