

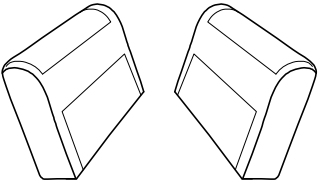

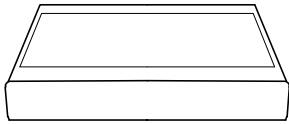
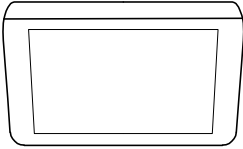

Carton A: A+C+D+E

Carton B: B+A+F+H+J+K

ASSEMBLE INSTRUCTION

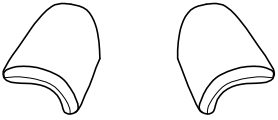
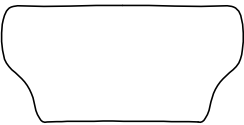
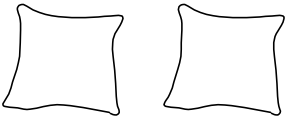
<p>A x2</p> 	<p>B x1</p> 	<p>C x1</p> 	<p>D x1</p> 
<p>E x2</p> 	<p>F x1</p> 	<p>H x2</p> 	<p>J x8</p> 
<p>K x1</p> 			

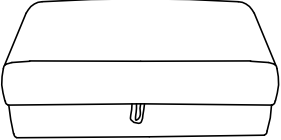
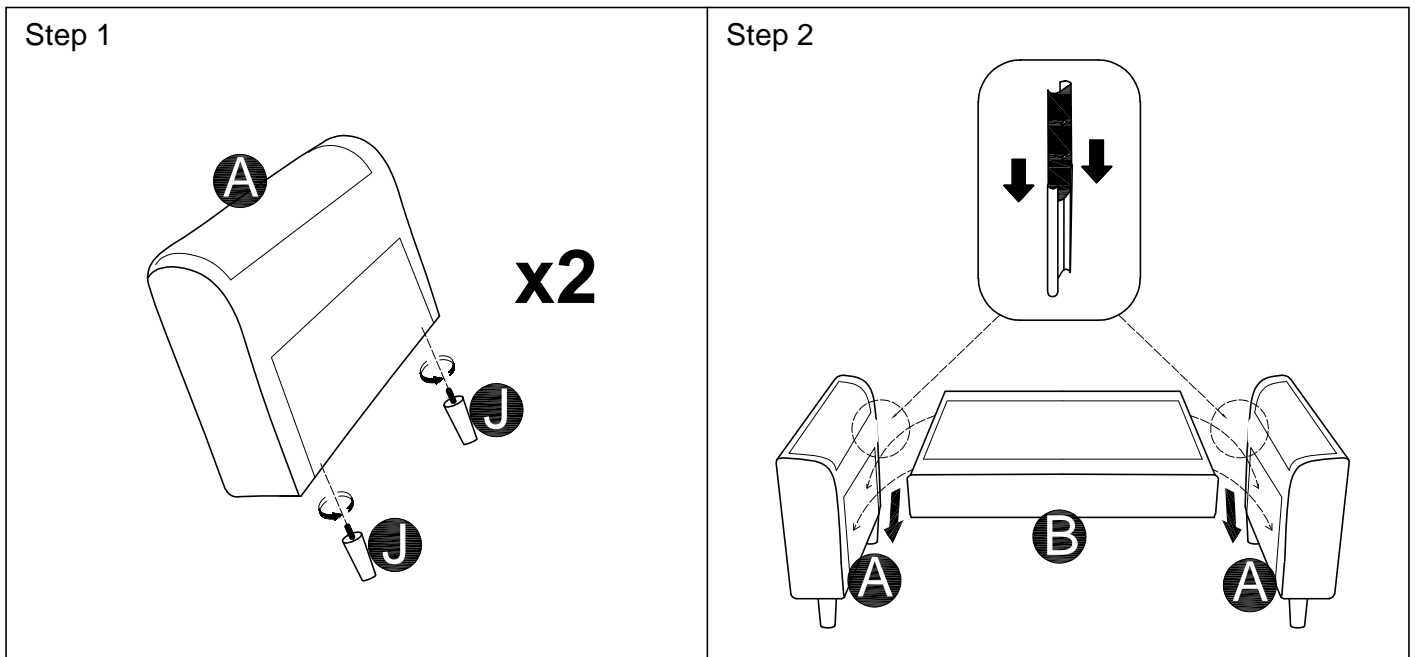

Step 3

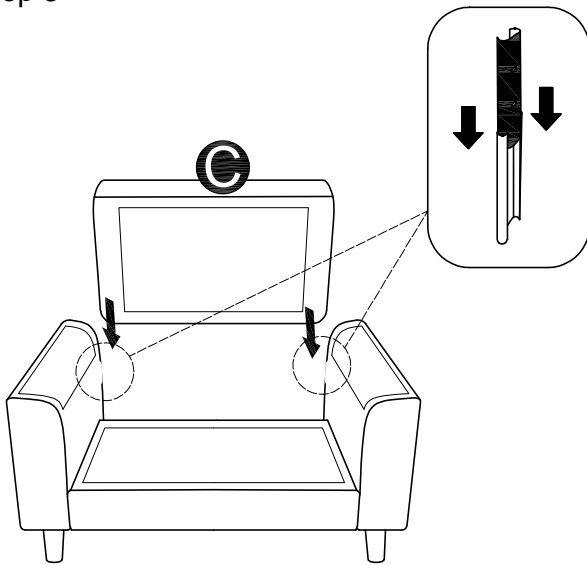

Step 4

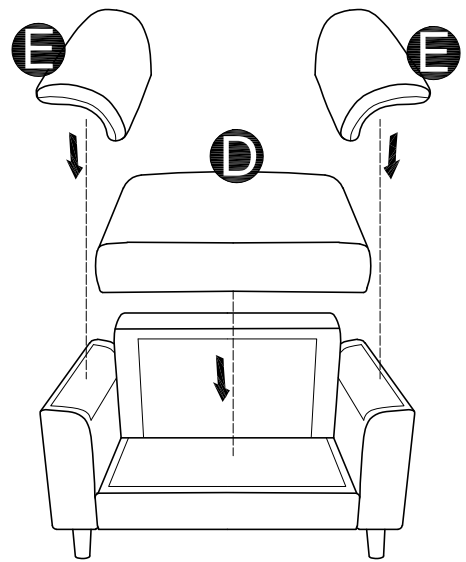

Step 5

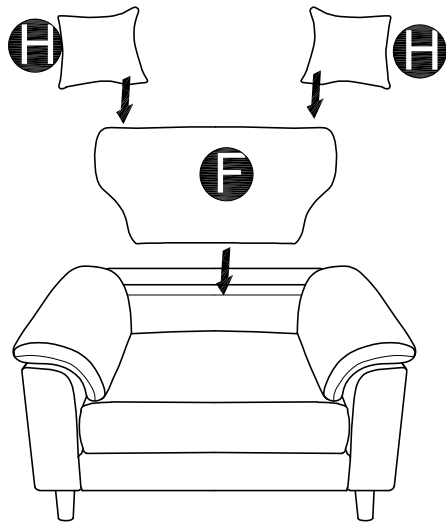

Step 6

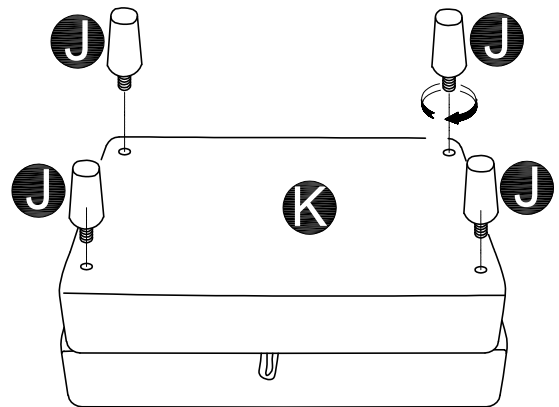

FINISH

