



626-679-3588
service@getprohome.com
www.getprohome.com
162 Atlantic St, Pomona, CA 91768

INSTALLATION MANUAL

Undermount/Drop-in Kitchen Sink



PRODUCT
INSTRUCTION
VIDEO

241910



THANK YOU!

Dear Valued Customer,

Thanks to your kind support of GETPRO, we hope our product can improve the quality of your life.

As our valued customer, your comments and opinions are very important to us. If you have any concerns, questions, or comments, we hope that you will bring them to our attention.

Please keep the carton and packaging materials until your product is completely installed.

Feel free to contact us if you encounter any problems such as missing parts, or product defects during the installation process. We are happy to provide you with the most sincere service.

*Sincerely,
Service Team*

Prior to Installation:

Inspect the sink prior to installation to make sure the sink has not been damaged during shipping.

- Observe all plumbing and building codes according to your state requirements.
- Additional floor and wall preparation may be required to avoid damaging the sink.
- Make sure to purchase the correct cabinet for your farmhouse sink. Farmhouse base cabinets should be 3" larger than the actual size of the sink.
- Not recommended to be installed with laminate countertop.

The step-by-step guidelines in the installation instructions are a general reference for installing a BESTGO Sink. Should there be any discrepancies, BESTGO cannot be held liable. It is recommended to install all BESTGO products by hiring a licensed professional.

TOOLS AND MATERIALS:

To install fireclay kitchen sink, you will need the following tools and materials:

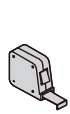

Tape Measure

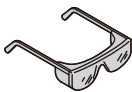

Eye Protector



Power Drill

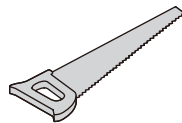

Hacksaw/Jigsaw

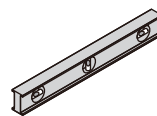

Level



Cleaning Rags

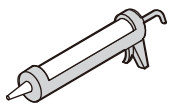

silicone adhesive sealant



Jig Saw

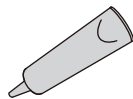

Silicone Sealant



Framing Square



Pencil(NO ink)

- Sealant - We recommend the use of a stone, marble and granite silicone caulk or a general purpose silicone sealant.
- Installation tools are not provided, please prepare by yourself.

Materials Included

- Kitchen sink
- Drain assembly
- Bottom Grid

Not Included

- Water supply lines
- Faucet
- Sink template
- Clips



Drop-in Style

DROP-IN INSTALLATION

Following these steps will help you install a drop-in fireclay kitchen sink effectively. Remember to refer to the BESTGO's specific installation instructions for your sink model to ensure you handle the installation correctly. If you encounter any challenges during the installation process, consider consulting a professional plumber for assistance.

1. MEASURE AND PLAN

Measure the cabinet opening where the sink will be installed to ensure the drop-in sink fits properly. Plan for any modifications needed to accommodate the larger size of the sink.

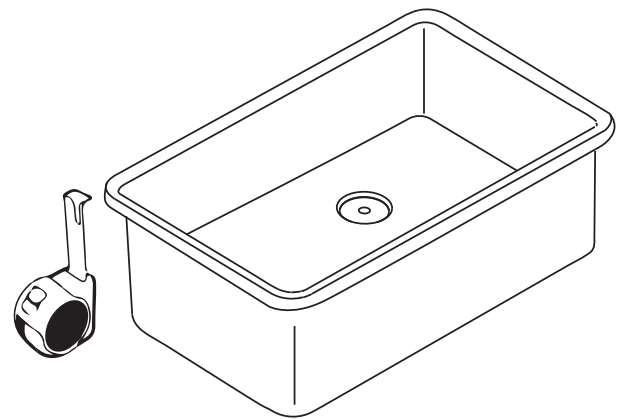

2. SUPPORT STRUCTURE

Reinforce the cabinet base to support the weight of the sink. Use support beams or brackets if necessary to provide adequate support.

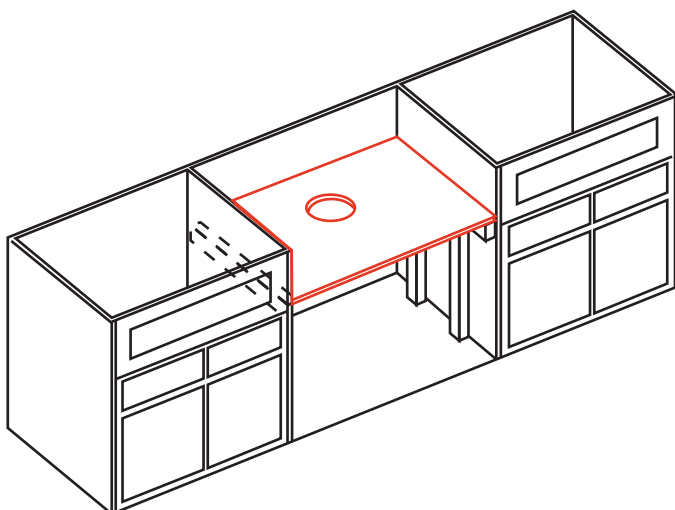
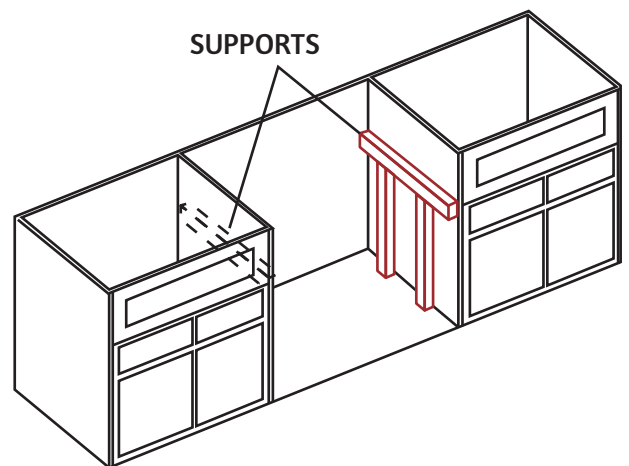

3. CREATE SUPPORT FOR SINK

Build a support frame or use adjustable supports to hold the weight of the sink. Make sure the sink will sit securely and level in the cabinet opening.

4.CUT COUNTERTOP

If the countertop needs to be modified to accommodate the sink, carefully measure and cut out the opening for the sink according to the actual sink specifications.

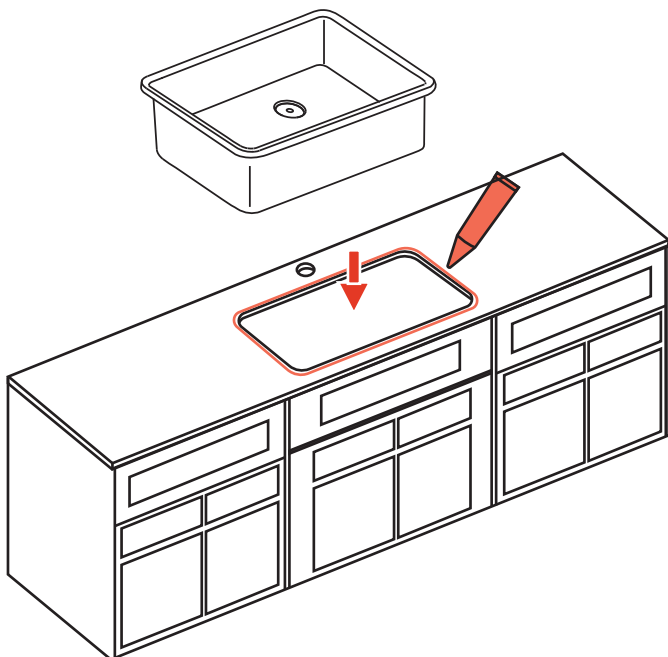
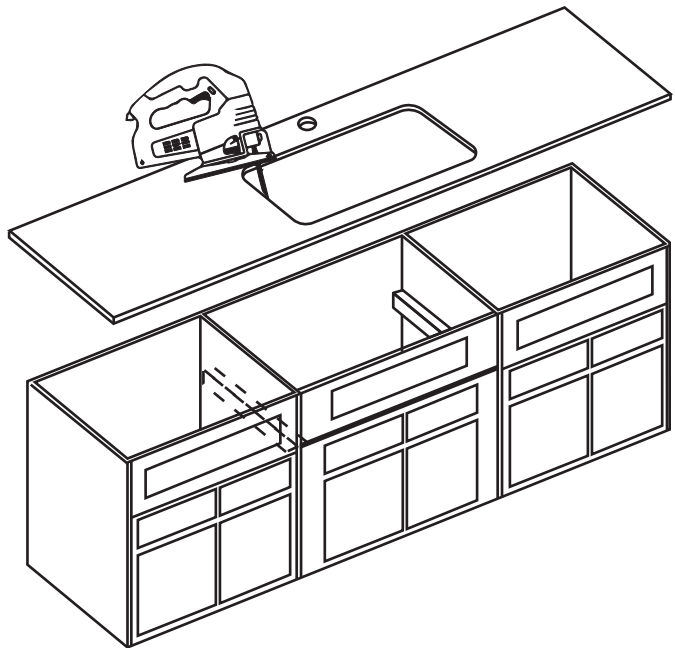

5.SINK PLACEMENT

Carefully lower the sink into the cabinet opening, ensuring it fits snugly and aligns correctly with the countertop.

6.FINISH INSTALLATION

Apply any sealant or caulk around the edges of the sink to prevent water seepage.
Double-check the sink for levelness and stability.

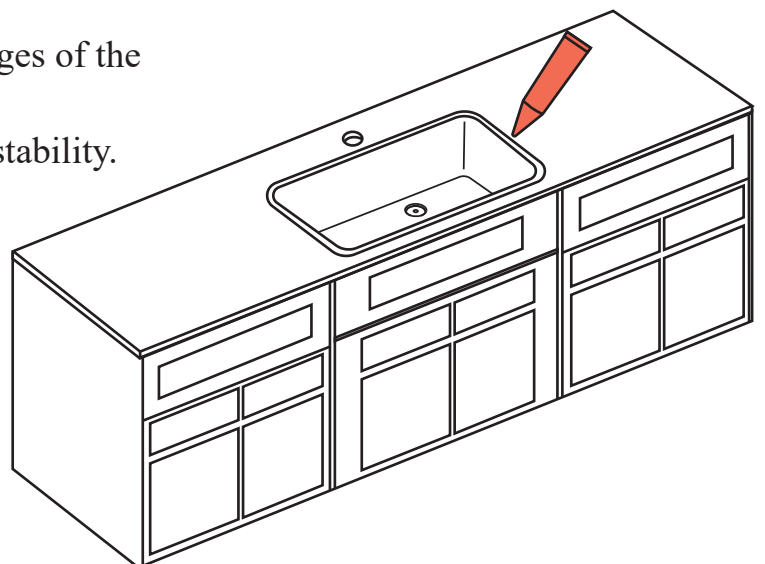

7. CONNECT PLUMBING

Connect the sink's drain pipes and any other plumbing components, ensuring a watertight seal. Check for leaks and make adjustments as needed.

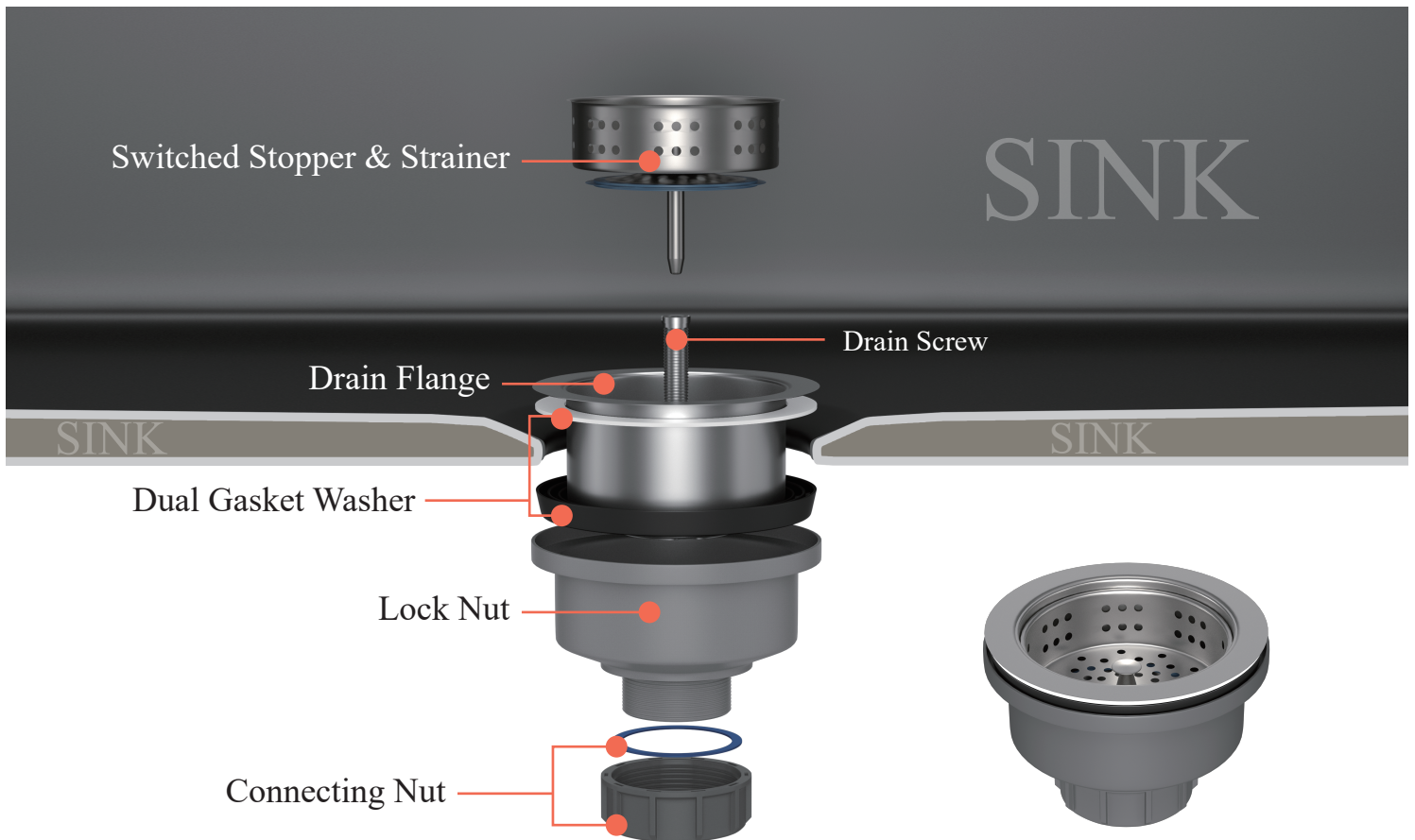

8. TEST THE SINK

Run water in the sink and check for any leaks or drainage issues. Make adjustments as necessary to ensure everything is working properly.

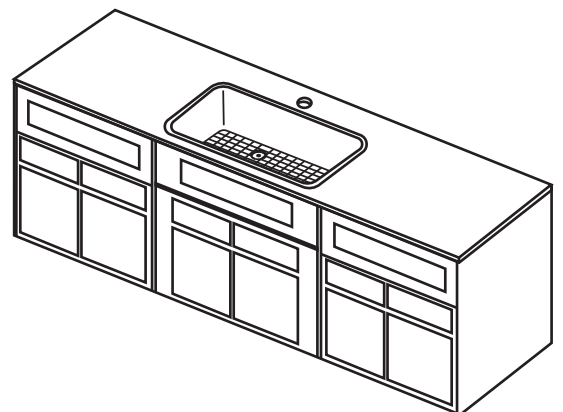

By following these steps you can successfully install a drop-in sink in your kitchen. If you're unsure about any step, consider consulting a professional plumber for assistance.



Under-mount Style

UNDER-MOUNT INSTALLATION

Following these steps will help you install a under-mount fireclay kitchen sink effectively. Remember to refer to the BESTGO's specific installation instructions for your sink model to ensure you handle the installation correctly. If you encounter any challenges during the installation process, consider consulting a professional plumber for assistance.

Positive Reveal-The countertop edge sits approximately $1/8"$ back from the edge of the sink, exposing the sink rim. All BESTGO undermount sinks feature a $1\frac{1}{2}"$ finished rim. All BESTGO undermount sinks feature an approximate $1/8"$ positive reveal.

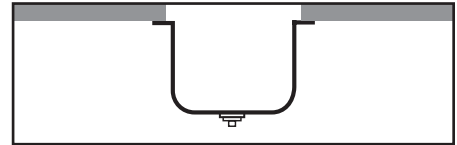

Zero Reveal-The countertop meets the edge of the sink, fitting flush with the sink bowls.

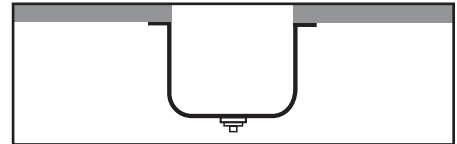

Negative Reveal-The countertop extends over the edge of the sink on all sides by approximately $1/8"$. Use caution with this installation to be sure that accessories such as colanders or cutting boards will fit properly.

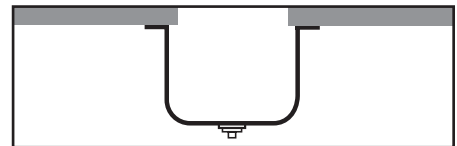

1.MEASURE AND PLAN

Measure the cabinet opening where the sink will be installed to ensure the under-mount sink fits properly. Plan for any modifications needed to accommodate the larger size of the sink.

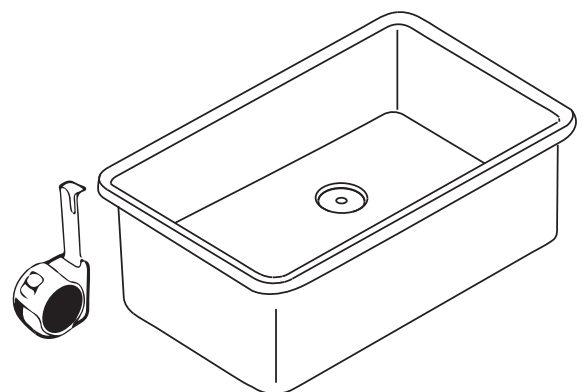

2.CUT COUNTERTOP

If the countertop needs to be modified to accommodate the sink, carefully measure and cut out the opening for the sink according to the actual sink's specifications.

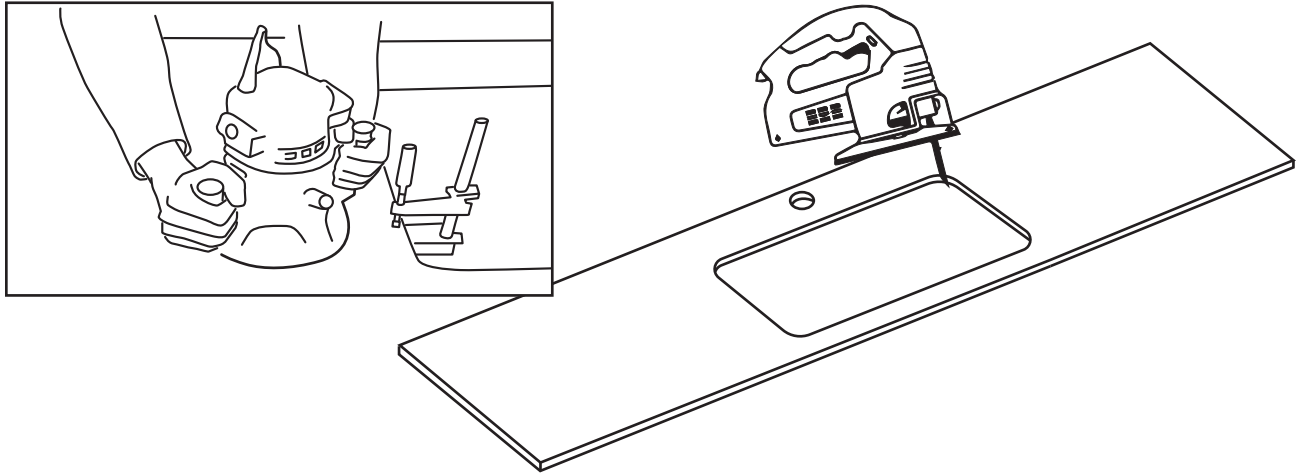

3.ATTACH THE UNDERMOUNT CLIPS.

(Recommended for professional installers only.)

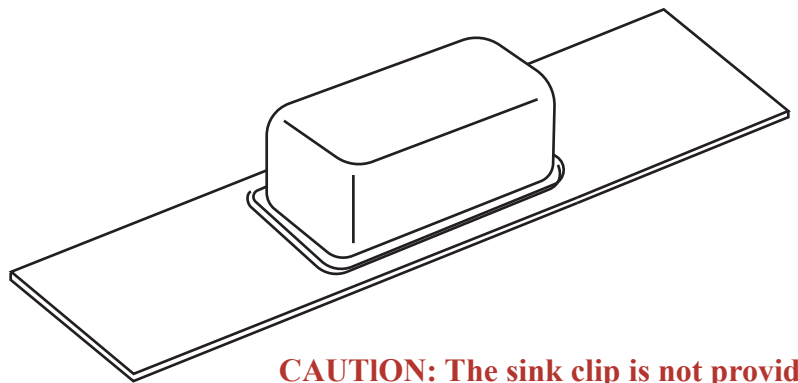
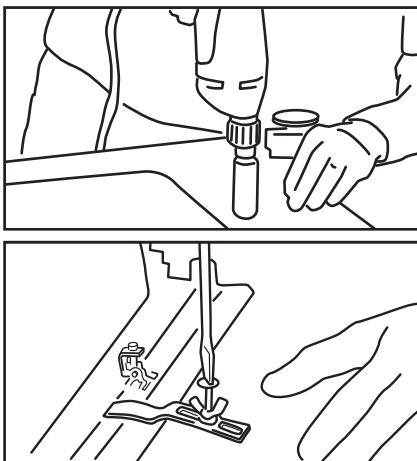

CAUTION: The sink clip is not provide, need to buy separately.

- Position bowl so that reveal is equidistant. Then on underside of countertop, drill holes for brass inserts for undermount clips. Use a drill bit with stop block to avoid drilling through the top. For 1/2" countertop material, drill 3/8" deep holes.
- Use three clips on the long sides of the sink, and two clips on the short sides of the sink, Drill the holes 1" back from the cutout edge.

4.FINISH INSTALLATION

Apply any sealant or caulk around the edges of the sink to prevent water seepage. Double-check the sink for levelness and stability.

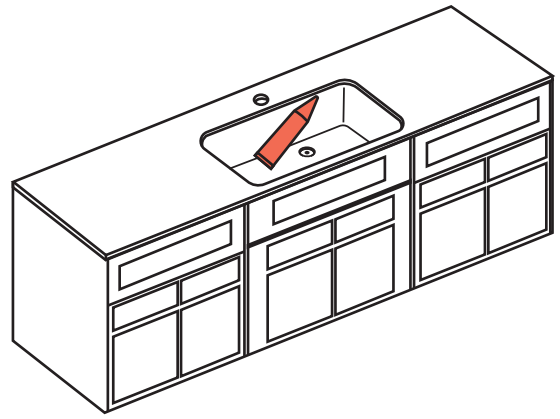

5.CONNECT PLUMBING

Connect the sink's drain pipes and any other plumbing components, ensuring a watertight seal. Check for leaks and make adjustments as needed.

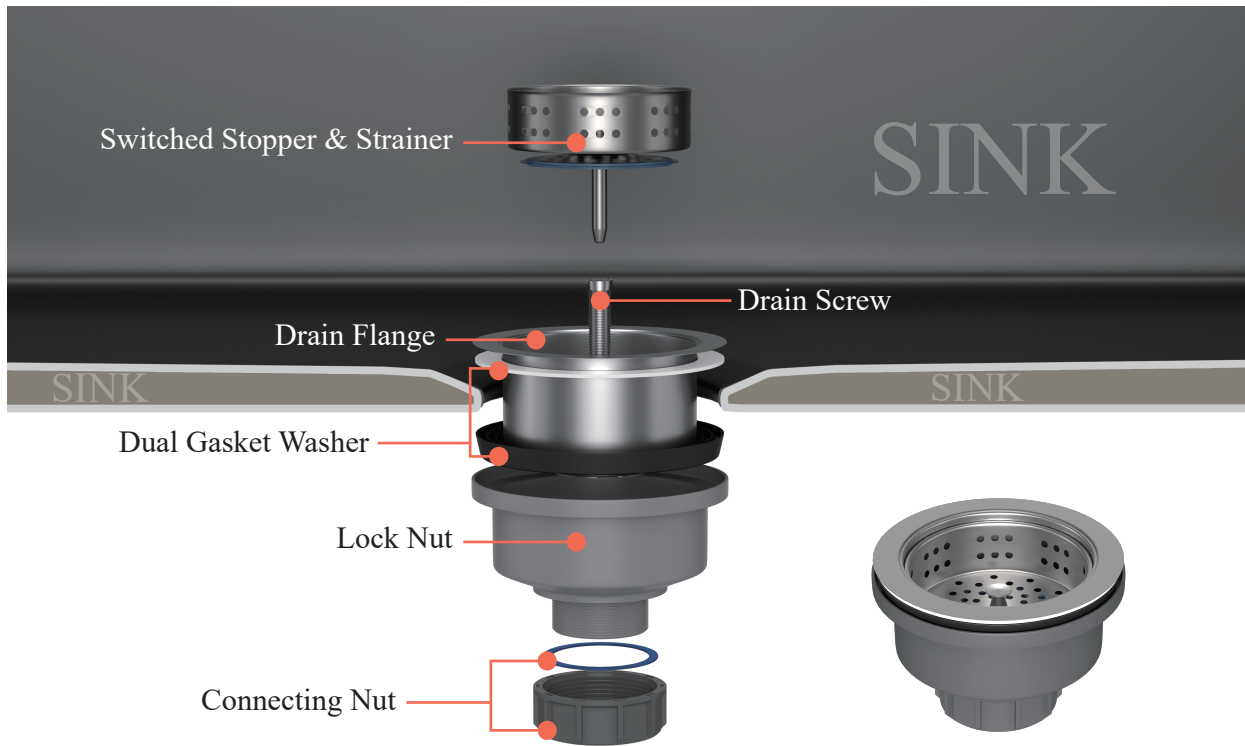

6.TEST THE SINK

Run water in the sink and check for any leaks or drainage issues. Make adjustments as necessary to ensure everything is working properly.

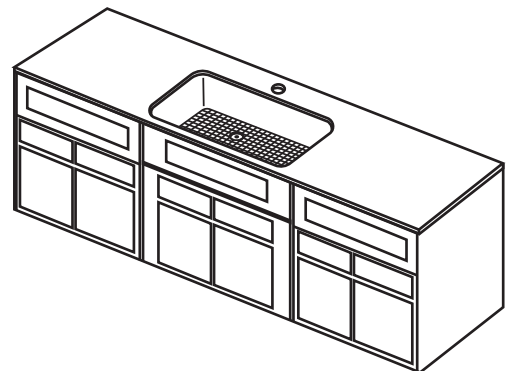

By following these steps you can successfully install a under-mount sink in your kitchen. If you're unsure about any step, consider consulting a professional plumber for assistance.

CARE & MAINTENANCE

To maintain a fireclay kitchen sink and keep it looking its best, follow these tips

1.REGULAR CLEANING

Clean your fireclay sink regularly with a mild soap or a non-abrasive cleaner and a soft cloth or sponge. Avoid using abrasive cleaners or harsh chemicals that can damage the sink's finish.

2.AVOID STAINING

Immediately rinse or wipe away any spills or stains to prevent them from setting onto the sink's surface. Avoid leaving coffee grounds, tea bags, or acidic foods in the sink for an extended period. For tough stains, you can use a paste of baking soda and water.

3.PREVENT SCRATCHES

Use a plastic or rubber mat at the bottom of the sink to prevent scratches from pots, pans, or utensils. Avoid using steel wool or abrasive pads to clean the sink.

4.AVOID EXTREME TEMPERATURES

While fireclay sinks are heat-resistant, avoid exposing them to extreme temperature changes. Do not pour boiling water directly into the sink or place hot cookware directly in the sink.

5.REMOVE METAL MARKS

If you notice metal marks left by pots or pans, gently scrub the sink with a mild abrasive cleaner or a mixture of baking soda and water to remove them.

6.MAINTAIN THE FINISH

Periodically apply a sink conditioner or polish specifically designed for fireclay sinks to maintain the finish and protect the surface.

7.PREVENT HARD WATER BUILDUP

To prevent hard water deposits, dry the sink after each use and consider using a mixture of water and vinegar to remove any buildup.

8.AVOID HEAVY IMPACT

Fireclay sinks are durable but can chip if hit with a heavy object. Be careful when placing pots and pans in the sink.

9.USE SINK GRIDS

To protect the sink bottom from scratches and dents, please use BESTGO sink grids which accompany the sink or other brand mats.

10.MAINTAIN THE DRAIN

Regularly clean the drain to prevent clogs and ensure proper drainage.

LIMITED WARRANTY COVERAGE

1 YEAR LIMITED WARRANTY

GETPRO products are made with quality materials and excellent craftsmanship to provide the customers a long-lasting product. In the case of any defects in materials or craftsmanship under regular use were inspected in the first one year of delivery, GETPRO will provide replacement parts at no charge, or at its option, replace any product or part of the product that is deemed defective, under normal installation, use, service and maintenance. This warranty applies only to the original purchaser. Proof of purchase will be required in the case of a claim.

GERPRO will, as its option

- (1) repair or replace the defective part(s) or product(s) at no charge;
- (2) issue a refund of the original purchase price of the product(s) (Valid within 30 days from the date of delivery);
- (3) Issue a credit to be applied toward the purchase of a new GETPRO product shipping/delivery charges may apply and are in GETPRO's sole discretion.

GETPRO recommends the installations to be made by a licensed, professional plumber. GETPRO will not be held responsible for any damage or product failure due to improper installation, misuse, or failure to use a licensed professional. GETPRO is not responsible for any removal or installation cost.

This limited warranty shall not apply to goods that have been subject to accident, negligence, improper installation, product abuse, product misuse, or use of cleaners containing abrasives, alcohol or other organic solvents, whether performed by a contractor, service company, or yourself, are excluded from this warranty.

GETPRO responsibility under this limited warranty is limited to only to replacement parts and no other costs.

GETPRO will not be responsible for labor charges and/or damage incurred by installation, repair, or replacement, nor for any indirect incidental or consequential damages, losses, injury, or costs of any nature relating to this product.

Except as provided by law, this limited warranty is instead of and excludes all other warranties, conditions, and guarantees, whether expressed or implied, statutory or otherwise, including without restriction those merchant ability of fitness for use.

RESPONSIBILITIES OF OTHERS

Inspecting the unit before installation is the responsibility of the installer or building contractor who acts on behalf of the user. They are responsible for ensuring the unit is free of defects or damage. Notices are placed on and in the unit and on the shipping carton advising the installer of this responsibility. In the event of a problem, the unit must not be installed.

GETPRO is not responsible for failures or damage that could have been discovered, repaired, or avoided by proper inspection and testing before installation.

Damage occurring in transit is the responsibility of the carrier. The user or installer **MUST** open the crate and inspect the unit for damage when it's delivered. If damage is discovered, it must be reported immediately to the seller and the carrier in writing, and an inspection requested. Failure of the carrier to respond should be reported to the seller and the carrier. Your freight claims should be filed promptly thereafter.

LIMITATIONS AND EXCLUSIONS

This warranty does not cover instances of negligence, misuse, abuse, improper installation, carelessness, accident, hard water or mineral deposits, exposure to corrosive materials, misapplication, damages caused by improper maintenance, alteration of the product, or failure to follow care or installation instructions enclosed with your product.

This warranty is void if the BESTGO is subject to alteration, or if repairs are attempted by anyone other than an authorized agent of BESTGO. This warranty does not extend to plumbing or components installed by dealers, installers or by any party other BESTGO.

BESTGO will not be liable for loss of use of the BESTGO inconvenience, or any other incidental or consequential costs, expenses, or damages. Please note that some states do not allow the exclusion or limitation of incidental damages.

DISCLAIMER

Except as expressly provided, there shall be no warranty or obligation, express or implied, oral or statutory. No dealer or other person has the authority to make any warranties or representations concerning GETPRO or its products. In no event shall GETPRO be held responsible for any such warranties or representations.

WARRANTY SERVICE

NOTE: When requesting a warranty, be sure to have the following:

- Copy of original invoice
- Date of installation
- Description and pictures of the defect
- Model number or description of the model

To obtain warranty service and replacement parts, please contact BESTGO Customer Service. BESTGO will determine whether to repair or replace your product, issue a refund, or issue a credit.

WARNING: Content may contain sharp and other possibly harmful pieces and may cause hazard to children and adults, BESTGO is not responsible in any way for personal damage.

HOME SERVICES



INSTALLATION VIDEO

Missing Part or Defective?

Please Contact the Customer Service Team

✉ service@getprohome.com

☎ 626 679 3588