

ASSEMBLY INSTRUCTIONS

174-916

TOOLS REQUIRED:

Allen Wrench (Provided, Part D)

BEFORE YOU START:

1. Check the hardware against the hardware list to make sure all items are present.
2. Assemble your furniture on a soft, flat surface to avoid scratching the finish.
3. **CAUTION:** Do not over tighten screws, nuts or bolts during assembly.
4. Your furniture may require occasional tightening.

INSTRUCTIONS:

Step 1. Turn the top upside down on a clean soft surface. Place three support leg frames to make the holes are aligned with the hole on top frame. Tighten Bolt (A) with Flat Washer (C)+Lock Washer (B) by Allen Wrench (D) as shown in Figure 1.

Step 2. Place the bottom shelf to legs and tighten Bolt (A) with Flat Washer (C)+Lock Washer (B) by Allen Wrench (D) as shown in Figure 2.

Step 3. Tighten Bolt (A) with Flat Washer (C)+Lock Washer (B) by Allen Wrench (D) as shown in Figure 3.

Step 4. Tighten all bolts and set table back upright as shown in Figure 4.

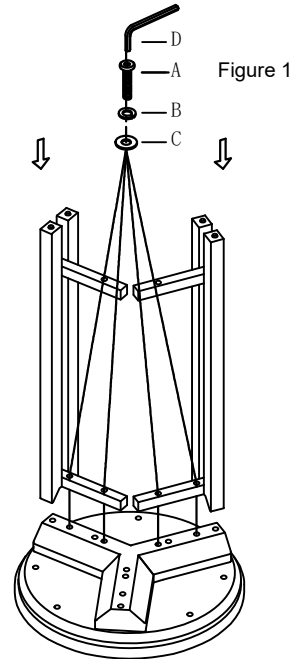
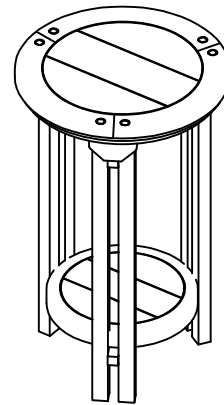

Figure 1

Step 1. Turn the top upside down on a clean soft surface. Place three support leg frames to make the holes are aligned with the hole on top frame. Tighten Bolt (A) with Flat Washer (C)+Lock Washer (B) by Allen Wrench (D) as shown in Figure 1.

Step 2. Place the bottom shelf to legs and tighten Bolt (A) with Flat Washer (C)+Lock Washer (B) by Allen Wrench (D) as shown in Figure 2.

Step 3. Tighten Bolt (A) with Flat Washer (C)+Lock Washer (B) by Allen Wrench (D) as shown in Figure 3.

Step 4. Tighten all bolts and set table back upright as shown in Figure 4.

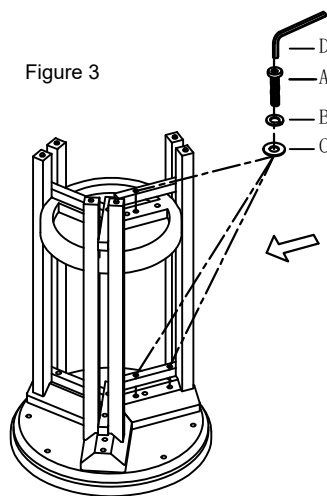

Figure 3

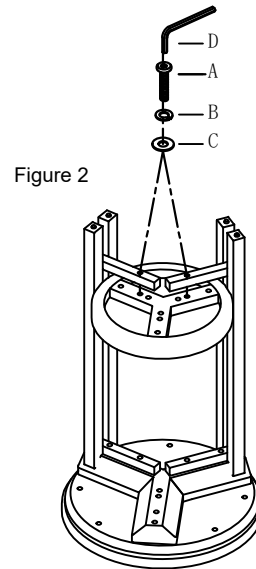
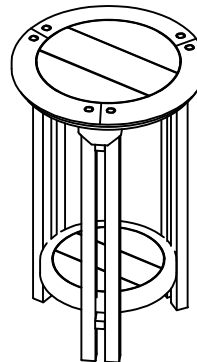





Figure 2

Figure 4



HARDWARE LIST			
A		Bolt (Ø1/4"x1-1/2")	9pcs
B		Lock Washer (Ø1/4")	9pcs
C		Flat Washer (Ø1/4")	9pcs
D		Allen Wrench (100*50*4mm)	1pc