











Instruction Manual

Thank you for purchasing this product. This product has been manufactured with the highest standards of safety and quality.

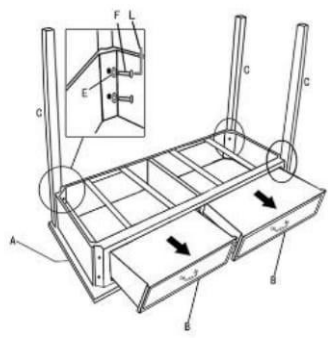
Product Name:	VINTAGE WOOD AND METAL CONSOLE TABLE
----------------------	--------------------------------------

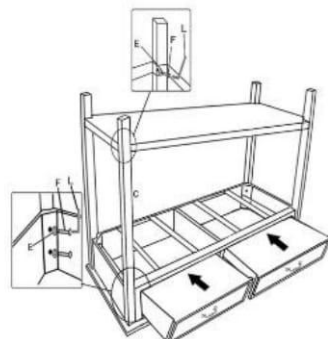
Console Cabinet Assembly:

 A 1PC	 B 2PCS	 C 4PCS	 D 1PC	 E 8PCS	 F 12PCS	 G 1PC
 <p>STEP 1</p>			 <p>STEP 2</p>			
 <p>STEP 3</p>			 <p>Completion</p>			

Important:

Tighten each cap nuts firmly. DO NOT over tighten any of the cap nuts as this may strip the screws. DO NOT sit or stand on the table as this may damage the product and cause serious bodily injury.

Tools required: Allen wrench (provided)

Instruction Manual

Product Name: VINTAGE WOOD AND METAL CONSOLE TABLE

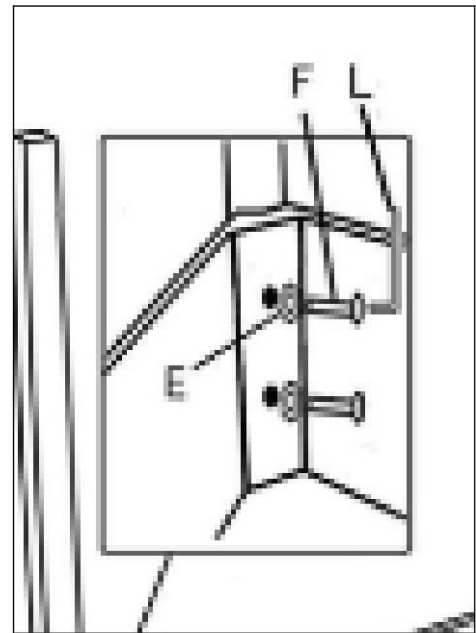
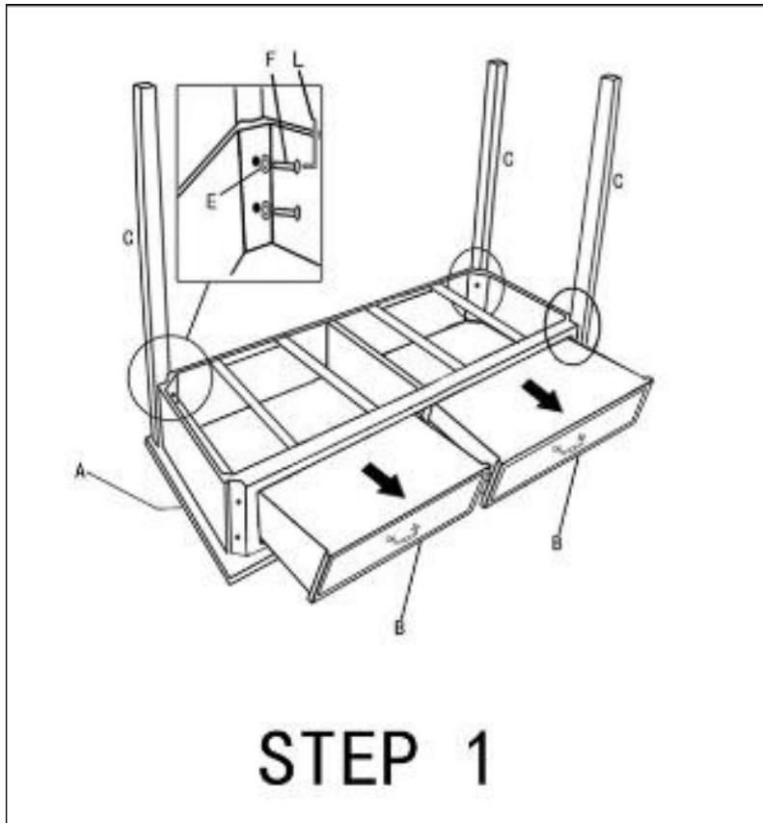

Remove drawers from console table and set aside. Turn table upside to assemble THREE legs to the table.

When placing the table upside down, please put on a clean surface (preferably soft) to avoid scratching.

Instruction Manual

Product Name: VINTAGE WOOD AND METAL CONSOLE TABLE

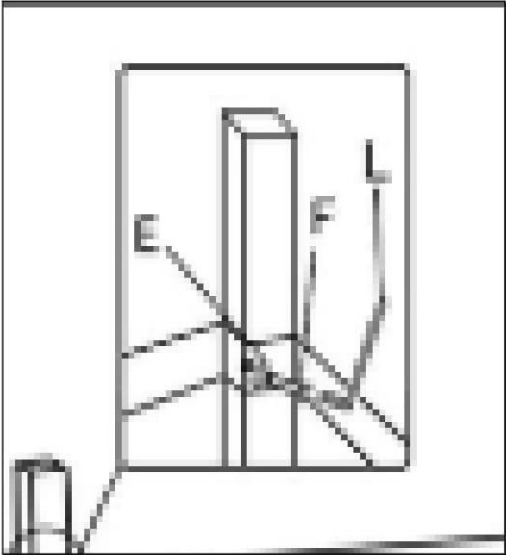

Attach bottom shelf to three of the legs.

Instruction Manual

Product Name: VINTAGE WOOD AND METAL CONSOLE TABLE

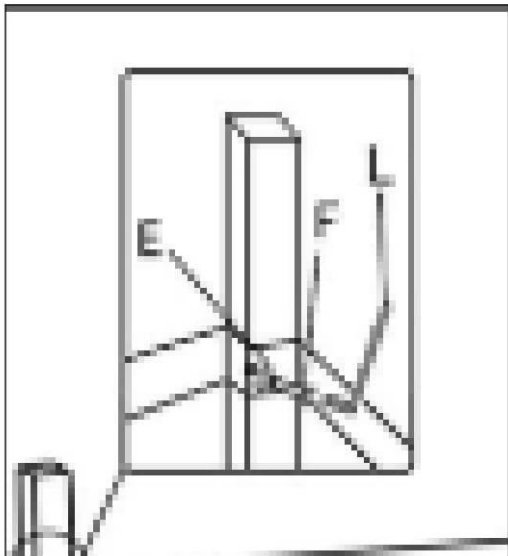
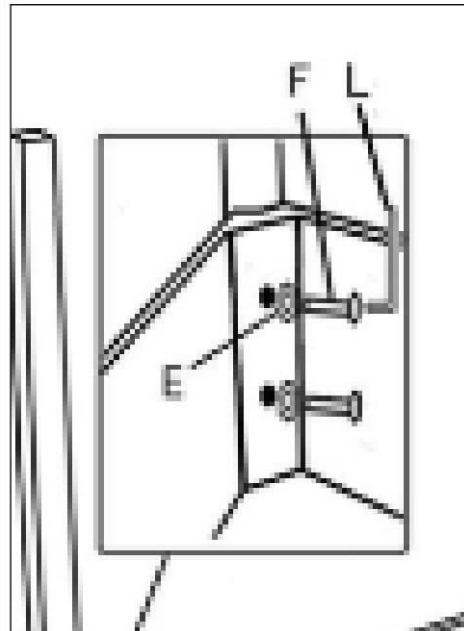

Assemble last leg to the table, and then attach shelf to the last leg.
Carefully flip table to upright position and put drawers back into the table.

Instruction Manual

Product Name:	VINTAGE WOOD AND METAL CONSOLE TABLE
----------------------	--------------------------------------



Enjoy your table!

Care and Maintenance:

Add 1 to 2 tablespoons of white vinegar (or you can use a small amount of non-abrasive dish soap – mild detergent soap) to a bowl of warm water and mix well.

Take a clean, soft cloth and moisten it in the water mixture.

Wipe the table with the moistened soft cloth. The vinegar and/or soap will help to disinfect.

Wipe the table again with a clean and dry cloth.

It is important to dry the table to prevent any moisture from soaking into the wood, which may cause it to warp or crack.