











ASSEMBLY INSTRUCTIONS

Caution : You must read this before you proceed

Care & Maintenance

| | |
|---|---|
|  | <ul style="list-style-type: none">● Not for commercial use. For residential use only. |
|  | <ul style="list-style-type: none">● Furniture may scratch floors. We recommend using furniture pads to protect your floors. |
|  | <ul style="list-style-type: none">● Do not put hot items directly on furniture surface. |
|  | <ul style="list-style-type: none">● Do not clean furniture with harsh cleansers or polish. |
|  | <ul style="list-style-type: none">● Do not place furniture under direct sunlight. |
|  | <ul style="list-style-type: none">● Do not place furniture near heating or cooling vents. |
|  | <ul style="list-style-type: none">● Do not write on furniture without a padded barrier to protect the surface. |
|  | <ul style="list-style-type: none">● Do not place furniture outside . For indoor use only. |
|  | <ul style="list-style-type: none">● Stains may be removed with mild soap solution and damp cloth. |
|  | <ul style="list-style-type: none">● Children should not climb or jump on the furniture. |
|  | <ul style="list-style-type: none">● Dust and pick-up spills using a clean, non-colored, lint-free cloth. |



Please look in underneath the **Table Top** for hardware packs.

COUNTER TABLE



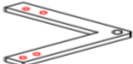
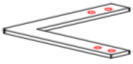

CAUTION: This COUNTER TABLE is NOT a TOY.
 Keep your child / children at bay during the assembly process.
 Whenever lifting or moving the COUNTER TABLE and to prevent any damage to it, two adults may be needed to execute these actions.

PART LIST:

| Label | Picture | Description | QTY |
|-------|---|-----------------|-----|
| A |  | Table Top | 1 |
| B |  | Legs | 4 |
| C |  | Left Stretcher | 1 |
| D |  | Right Stretcher | 1 |

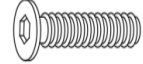
HARDWARE





| Label | Picture | Description | QTY |
|-------|---|-------------------------------|-----|
| ① |  | Bolt (Ø1/4"x38mm) | 9 |
| ② |  | Bolt (Ø1/4"x25mm) | 9 |
| ③ |  | Spring Washer (Ø1/4"x11mm) | 9 |

| | | | |
|---|---|-----------------------------|--------------|
| ④ |  | Flat Washer (Ø1/4"x19mm) | 9 |
| ⑤ |  | Allen Wrench (M4) | 1 |
| ⑥ |  | Cam Lock (Ø15*9.5mm) | 2 |
| ⑦ |  | Cam Bolt (Ø6*33.5mm) | 2 |
| ⑧ |  | Screw Driver | Not Provided |

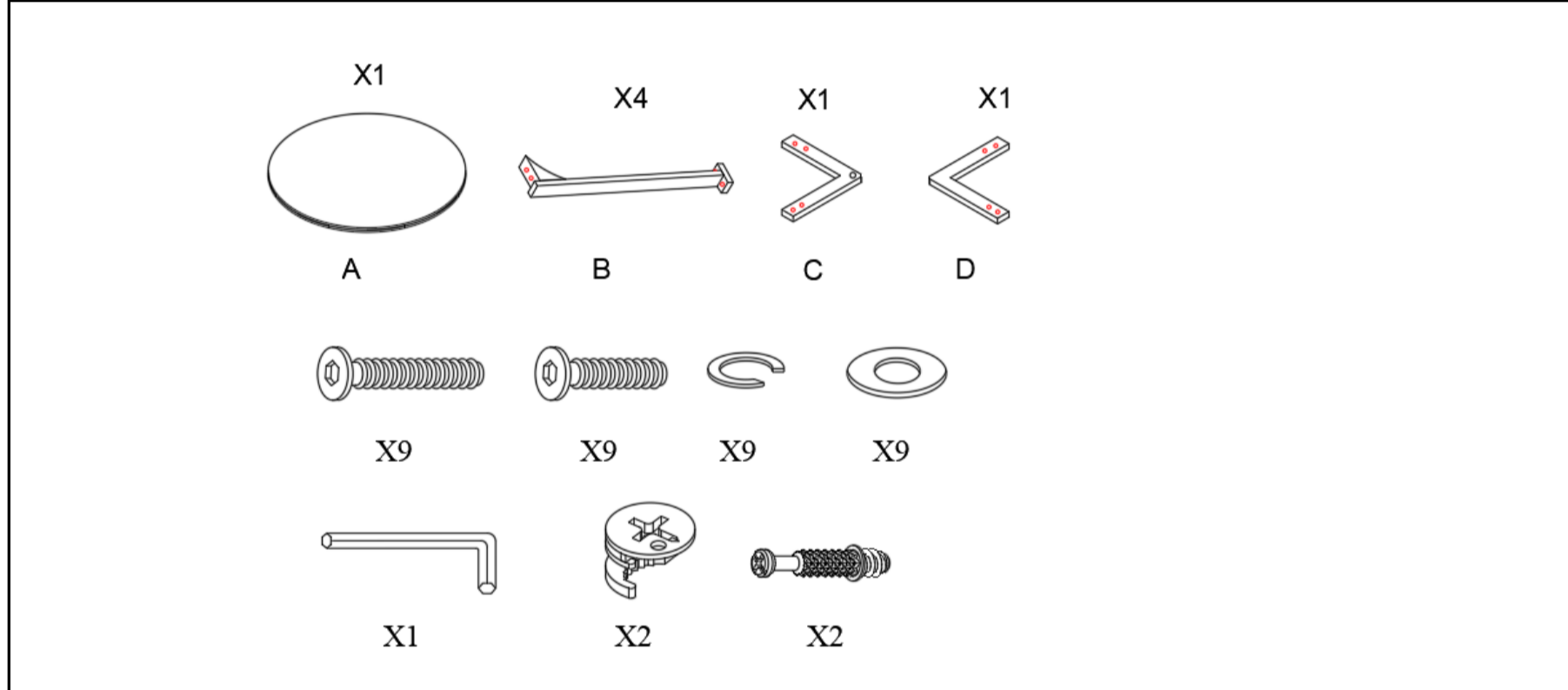
ASSEMBLY PREPARATION

Before Beginning Assembly:

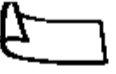

-  • **Read instructions, cover to cover-**
-  • **Have 2 adults on hand for assembly-**
-  • **Do not assemble on flooring or carpet-**
-  • **Assemble on a clean non-marring surface (packing foam)-**
-  • **Save all packaging until finished-**

ASSEMBLY STEPS

Overview

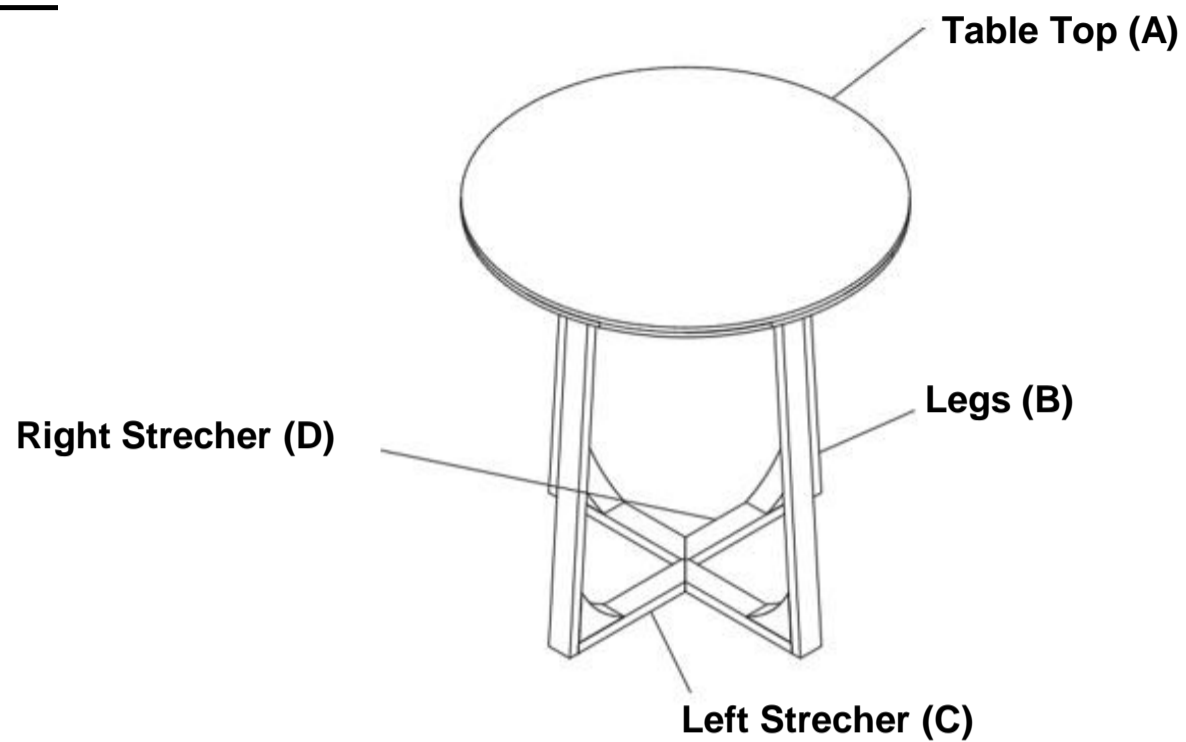

This COUNTER TABLE has multiple parts and may require up to 30 minutes to assemble. To give you an overview of the COUNTER TABLE parts, the above picture is provided to help you put the various parts into perspective. Please read through the instructions below to familiarise yourself with the parts and steps before assembly.

Step 1

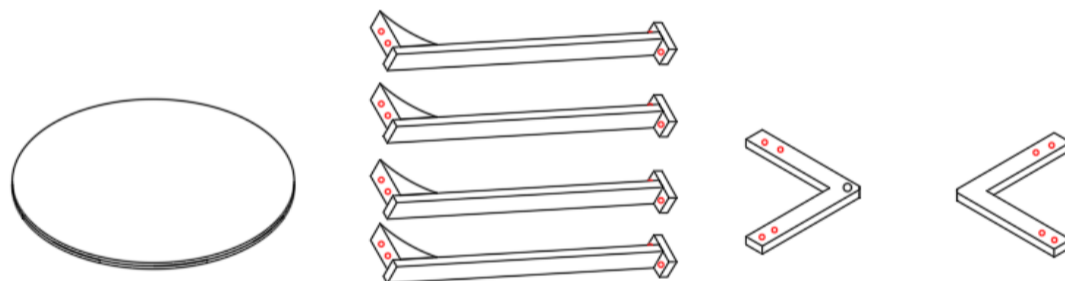

Unpack and place all parts on a clean, non-marring surface.

Step 2

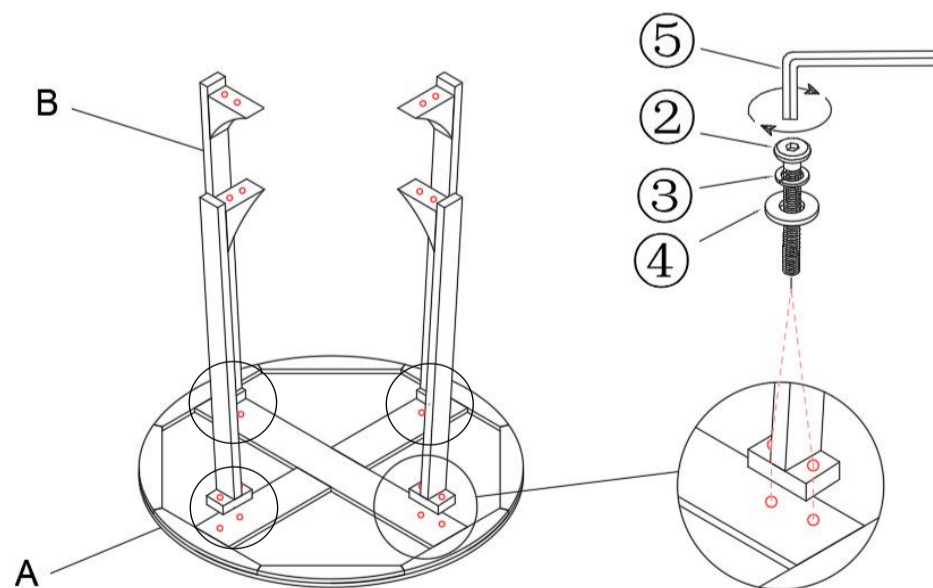

1. Place the Table Top (A) on a clean, non-marring surface to avoid any scratches or damages to the product.
2. Attach the Legs (B) to the Table Top (A) by using bolts (②), Spring washer (③), Flat Washer (④) and Allen Wrench (⑤) as shown above

DO NOT fully tighten the Bolts at this time.

Step 3

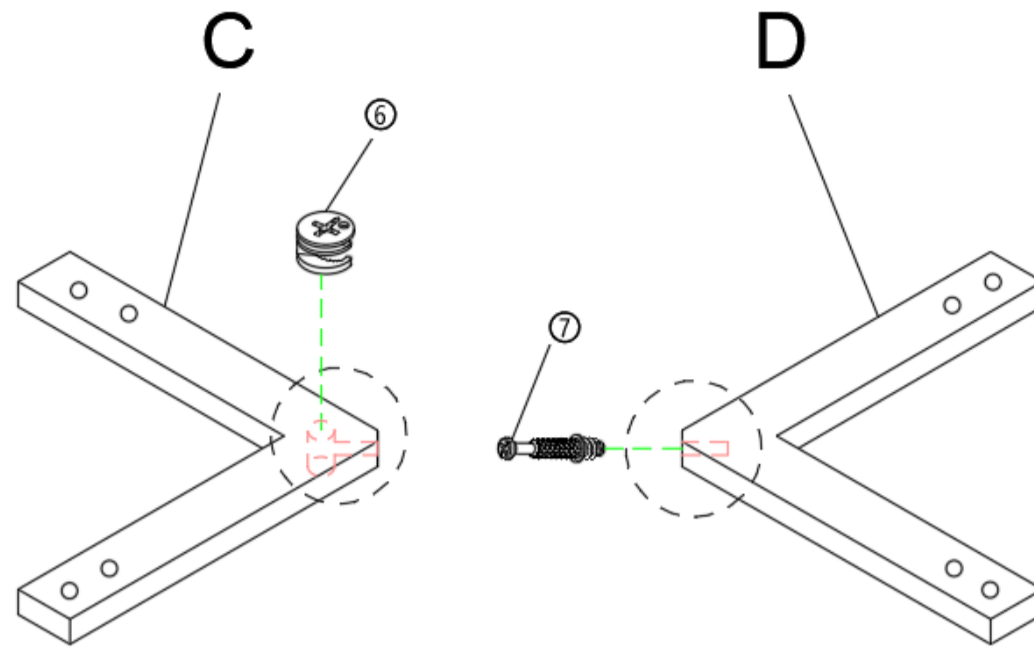

Put Left Strecher (C) has a Cam Lock (6) attached and Right Legs (D) has Cam Bolt (7) attached as instrusted above picture

Step 4

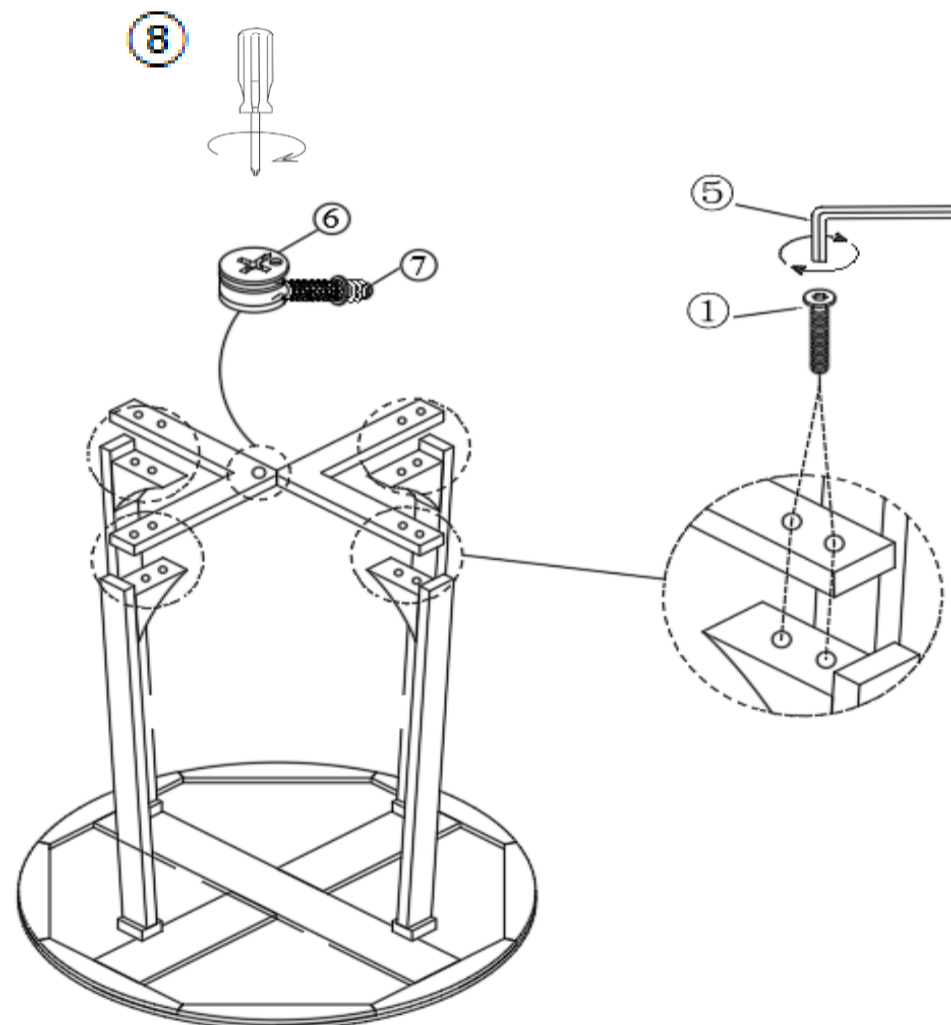

With the help from your partner, turn the COUNTER TABLE is now facing skywards.

1. Fully tighten the Cam Lock (6) by using Screw driver (8) and Cam Bolt (7) by Allen Wrench (5) at this time.

2. Attach the assembled parts has just finished above to the assembled parts in Step 2 by using 4pcs of Bolts (1) and the Allen Wrench (5) as shown picture.

Do not fully tighten the Bolts at this time.

Step 5



Turn the COUNTER TABLE right side up

Place the COUNTER TABLE on a flat, level surface to make sure it is balance.

Inspect the COUNTER TABLE and make sure all parts are adequately connected. Then EXERT pressure, floorwards onto the COUNTER TABLE with both hands. This pressure will help align all parts at all joints. Check for wobbles on a LEVEL surface.

If no wobbles are found proceed to tighten the Screws in a sequential manner, until evenly secured.

CAUTION 1: When tightening these screws, tighten sequentially.

DO NOT tighten any screw fully and then towards the next one. This would cause the frame to warp.

WARNING ! IF THE COUNTER TABLE IS NOT STABLE , IT COULD LEAD TO DAMAGING THE PRODUCT.

Your COUNTER TABLE is ready to be used.

CAUTION 2: This COUNTER TABLE can only be used on a flat, level surface.

Questions & Answers about Proposition 65

- What is Proposition 65?

Proposition 65 requires businesses to provide warnings to Californians about significant exposures to chemicals that cause cancer, birth defects or other reproductive harm. These chemicals can be in the products that Californians purchase, in their homes or workplaces, or that are released into the environment. By requiring that this information be provided, Proposition 65 enables Californians to make informed decisions about their exposures to these chemicals.

Proposition 65 also prohibits California businesses from knowingly discharging significant amounts of listed chemicals into sources of drinking water.

Proposition 65 requires California to publish a list of chemicals known to cause cancer, birth defects or other reproductive harm. This list, which must be updated at least once a year, has grown to include approximately 900 chemicals since it was first published in 1987.

- What types of chemicals are on the Proposition 65 list?

The list contains a wide range of naturally occurring and synthetic chemicals that include additives or ingredients in pesticides, common household products, food, drugs, dyes, or solvents. Listed chemicals may also be used in manufacturing and construction, or they may be byproducts of chemical processes, such as motor vehicle exhaust.

- What does a warning mean?

If a warning is placed on a product label or posted or distributed at a workplace, a business, or in rental housing, the business issuing the warning is aware or believes that it is exposing individuals to one or more listed chemicals.

By law, a warning must be given for listed chemicals unless the exposure is low enough to pose no significant risk of cancer or is significantly below levels observed to cause birth defects or other reproductive harm.

- Where can I get more information on Proposition 65?

If you have specific questions on the administration or implementation of Proposition 65, you can contact OEHHA's Proposition 65 program at P65.Questions@oehha.ca.gov, or by phone at (916) 445-6900.