

ASSEMBLY AND OPERATING INSTRUCTIONS











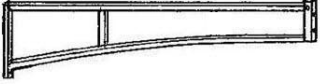



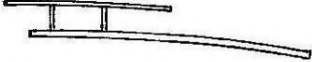
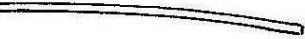

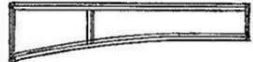
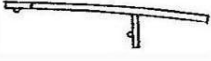
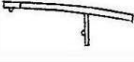

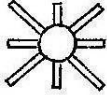

FOR MODEL:GHG-1012

Manufacture Recommendation:

1. All steel furniture has the potential for rust if the paint is scratched and bare metal is exposed to air and water. Apply clear rust inhibitor (such as Paint) immediately after assembling the furniture to prevent rusting.
2. It is recommended to remove the canopy top during inclement weather.

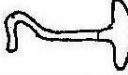
Parts List

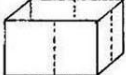
Part#	Description	Qty
A		2
B		2
A1		4
A2		4
C		4
C1		4
D		4
E1		2
E2		2
F		2
G		2
H1	M6×32 	8+1
H2	M6×15 	8

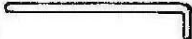
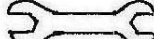
Part#	Description	Qty
H3	M6×20 	16+1
K		1
M		1
N		1
O		48+4
P		1
S		1
V		4
W		1
X		1
Y		8
Z		1

Assembly Diagram

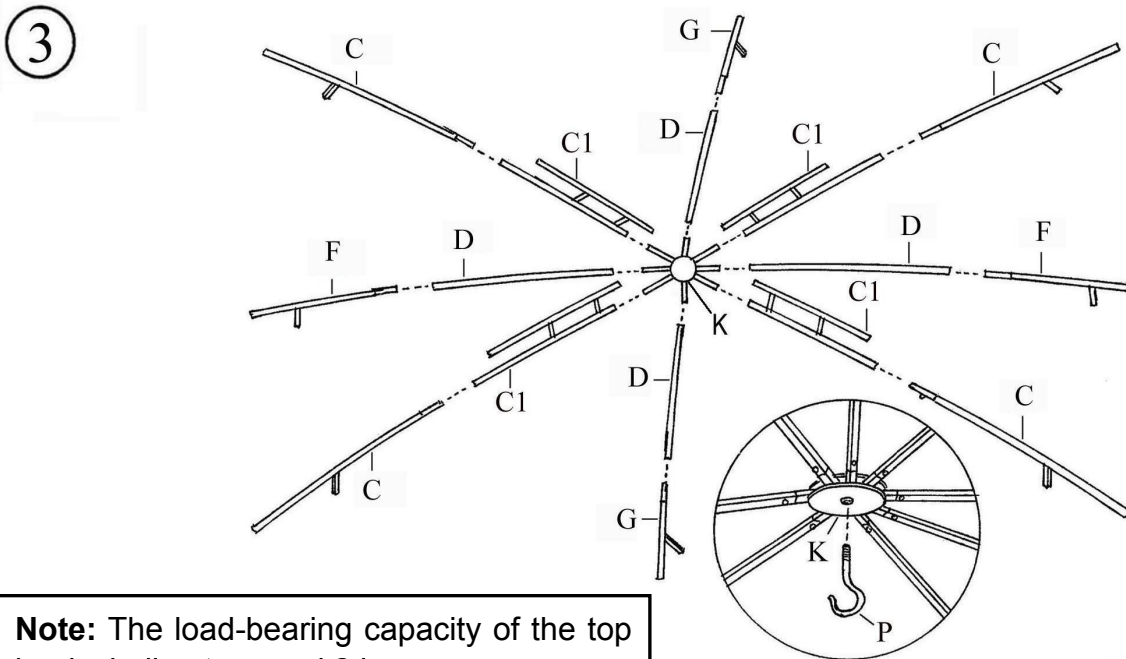
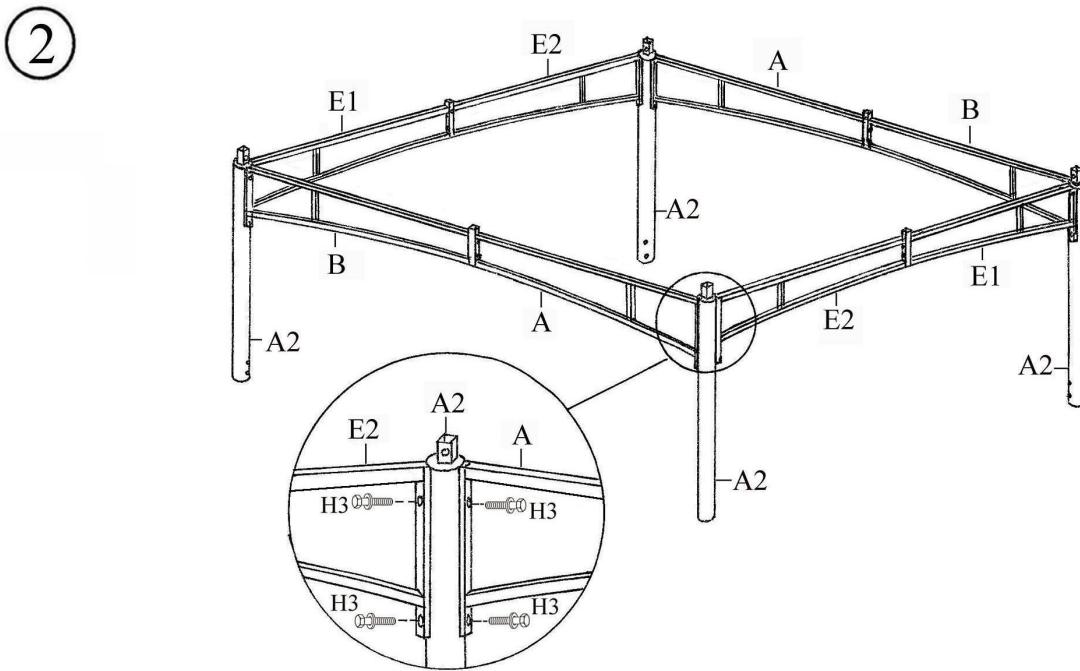
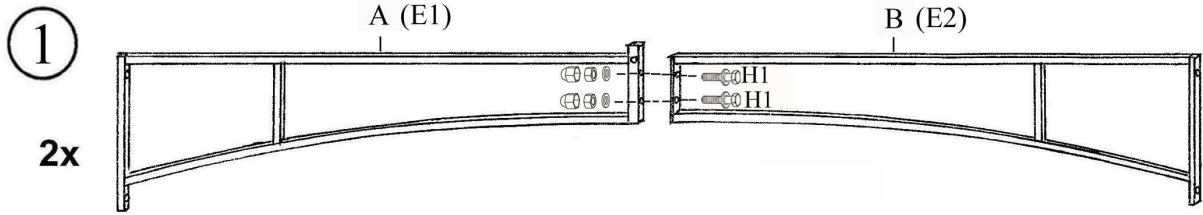

Note: The load-bearing capacity of the top hook shall not exceed 2 kg.

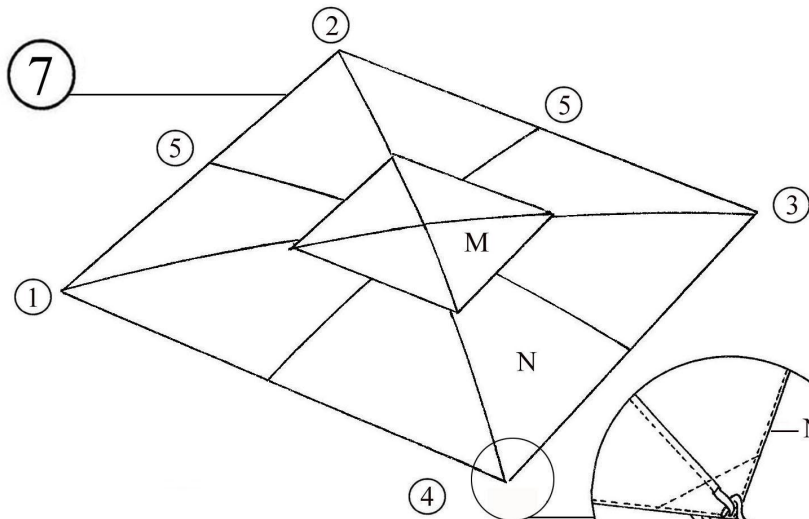

Note: This corner pocket be inserted must using the hook S.

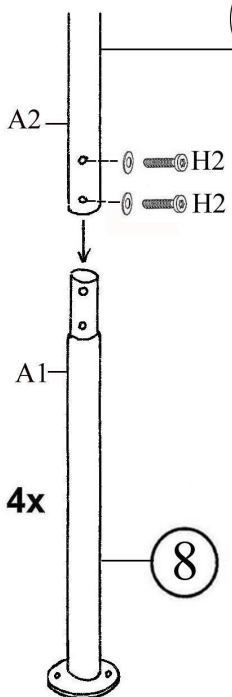
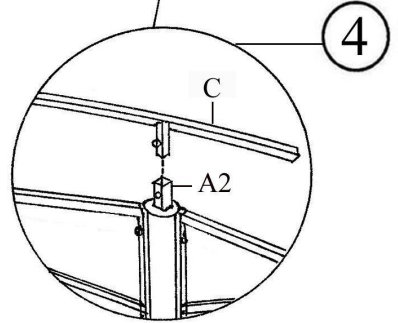
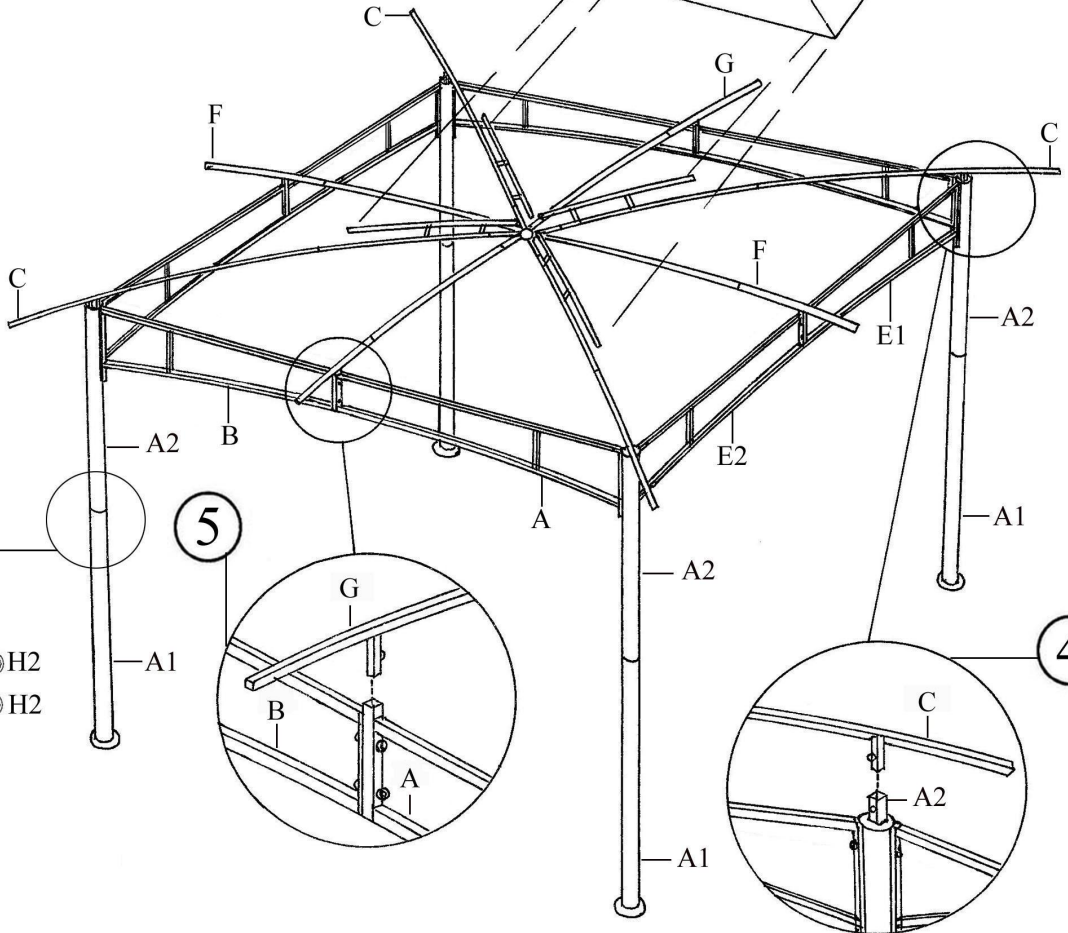
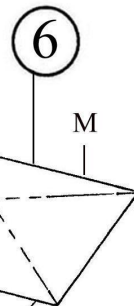
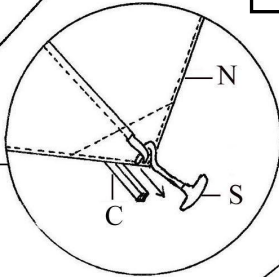

9

