

Installation & Assembly



Per Seat Weight Limitation

300 LBS

Thank You For Choosing Our Furniture

▾ If you have any questions or concerns,
don't hesitate to reach out to us. ▴

NOTE:







This brochure contains
IMPORTANT safety info.
Please read and keep it
for future reference.

MAINTAINANCE AND WARNINGS



Before You Start

Please follow the steps below:



-  Un box the package and check if all parts and accessories are complete.
-  Place the parts of the chair on a flat surface.
-  Ensure the chair is placed on a stable, flat surface to prevent it from tilting.
-  Avoid placing sharp or heavy objects directly on the chair to prevent tears or deformation.
-  Clean the installation area in advance and ensure the ground is level and there is enough space to avoid damaging the furniture or making installation difficult.
-  Lay a protective mat on the ground to prevent scratching the floor during installation.

After-Sales Service

- If you encounter any issues or need technical support during use, please contact our after-sales team. We offer long-term maintenance and warranty services.





Precautions

-  This chair is for indoor use only. Do not expose it to outdoor elements or high-humidity environments.
-  Keep the product away from high heat or open flames to prevent fire hazards.
-  Do not allow children or pets to play on the chair unsupervised to avoid accidents.



Safety Warnings

-  If you notice any loose or damaged parts, stop using the sofa immediately and contact customer service.
-  Do not attempt to disassemble or replace any components yourself, as this may affect the stability and safety of the product.

Daily Maintenance

- Regularly clean the surface of the sofa with a chair cloth to prevent dust accumulation.
- For fabric chairs, it is recommended to vacuum weekly and clean the fabric as needed.
- For leather chairs, use a leather cleaner regularly to clean and maintain the material. Avoid direct sunlight to prevent leather aging.
- In case of spills, immediately blot the area with a clean, dry cloth

Parts List

A

x1

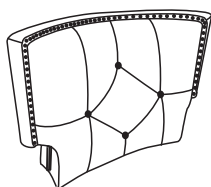

Backrest

B

x1

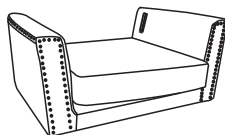

Seat Frame

C

x1



Mechanism

D

x1

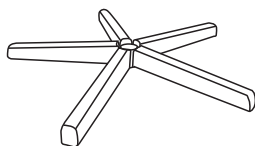

Spider base

E

x1



Gas lift



F

x5



Casters

Hardware List

<p>1 x4</p>  <p>Ø6x20mm</p>	<p>2 x1</p>  <p>M6</p>	
--	---	--

Hardware Spare List

<p>1 x1</p>  <p>Ø6x20mm</p>		
--	--	--



Installation:
15minutes.



One Person

Step 1

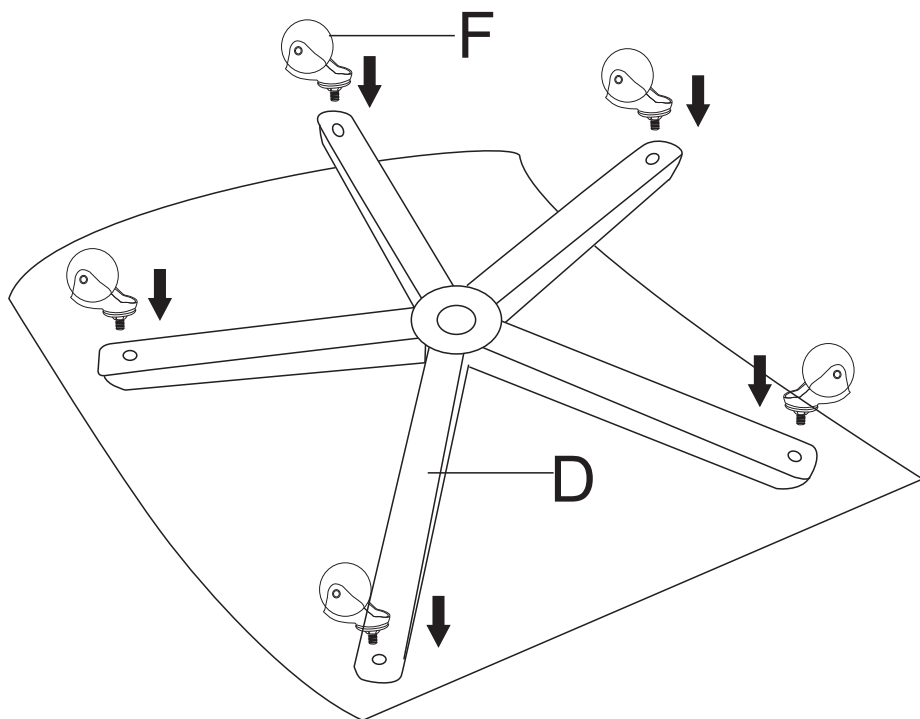

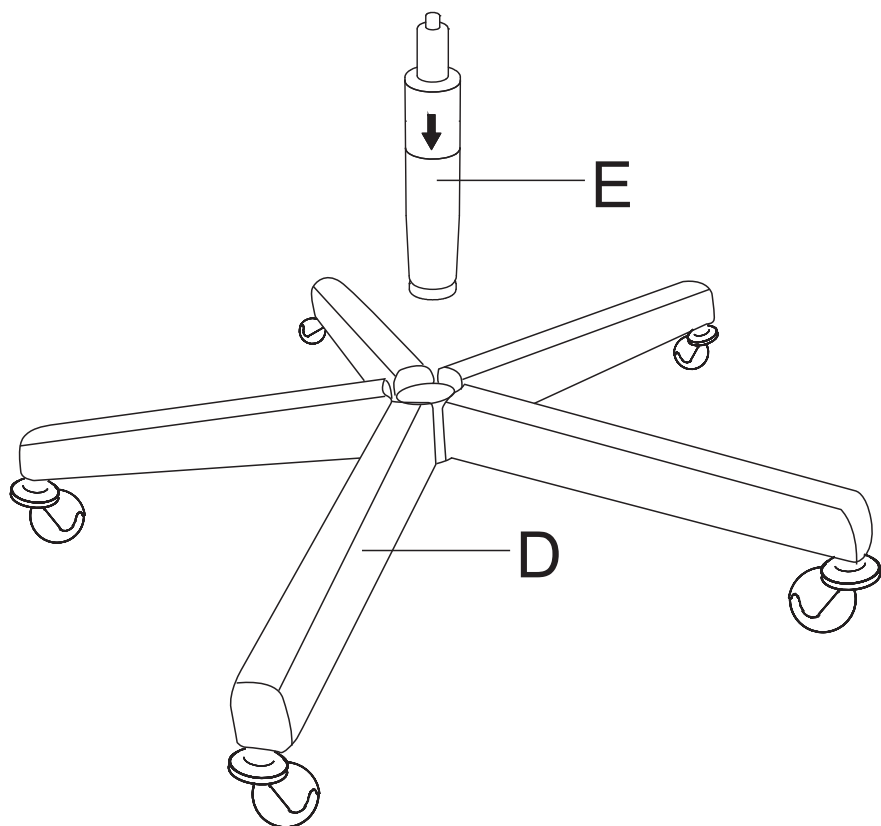

Step 2

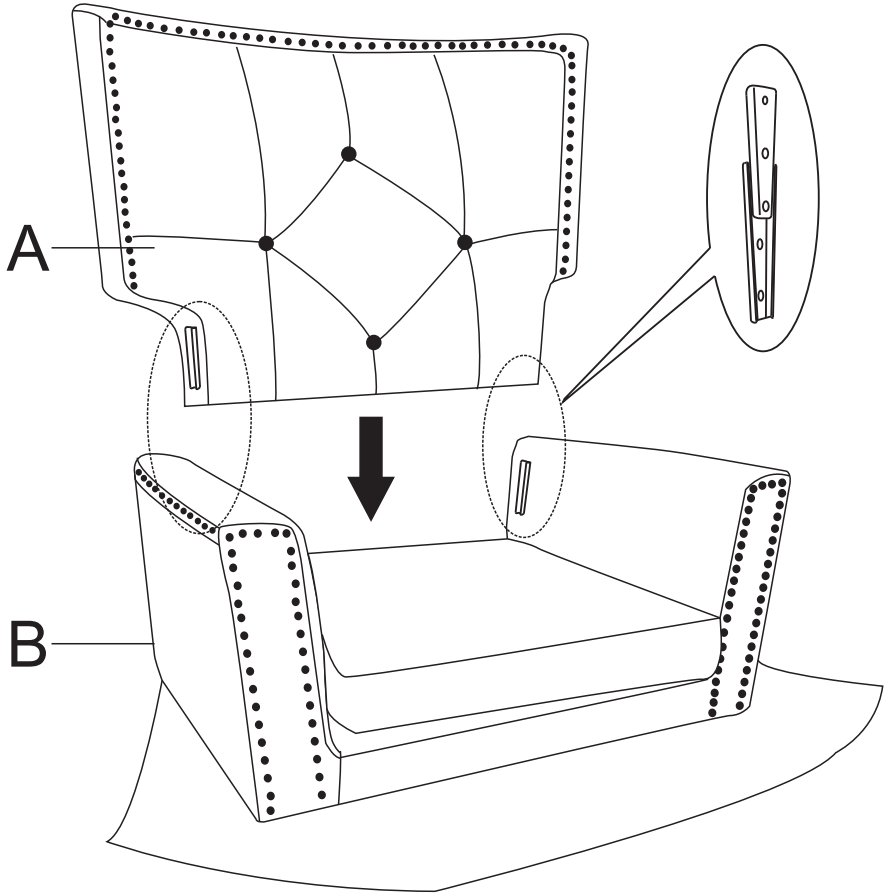

Step 3



Step 4

#1	x4	#2	x1
			
M6*20mm		M6	

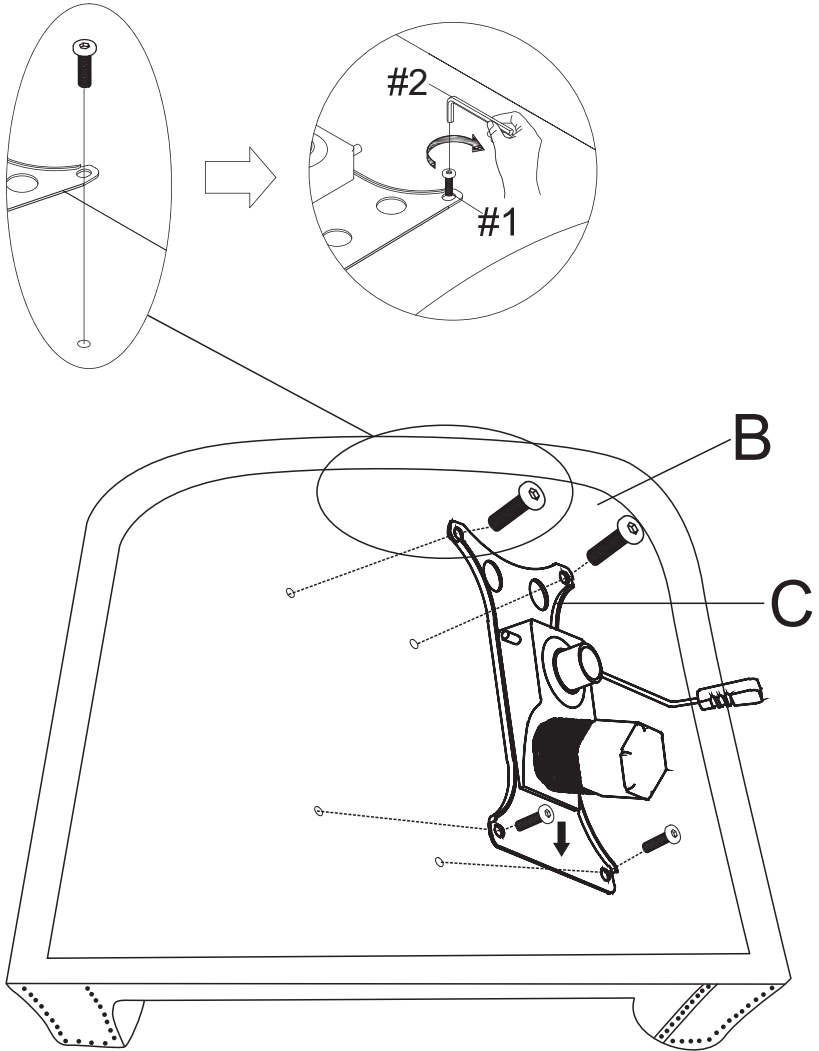

Step 5

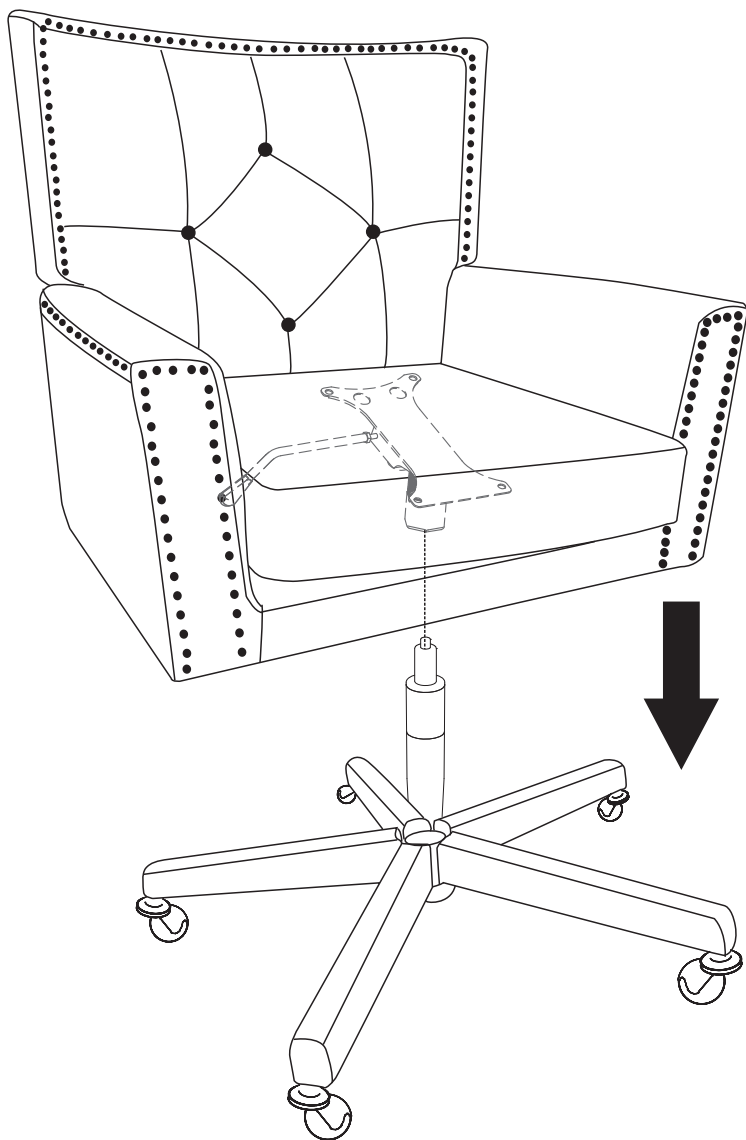

Step 6

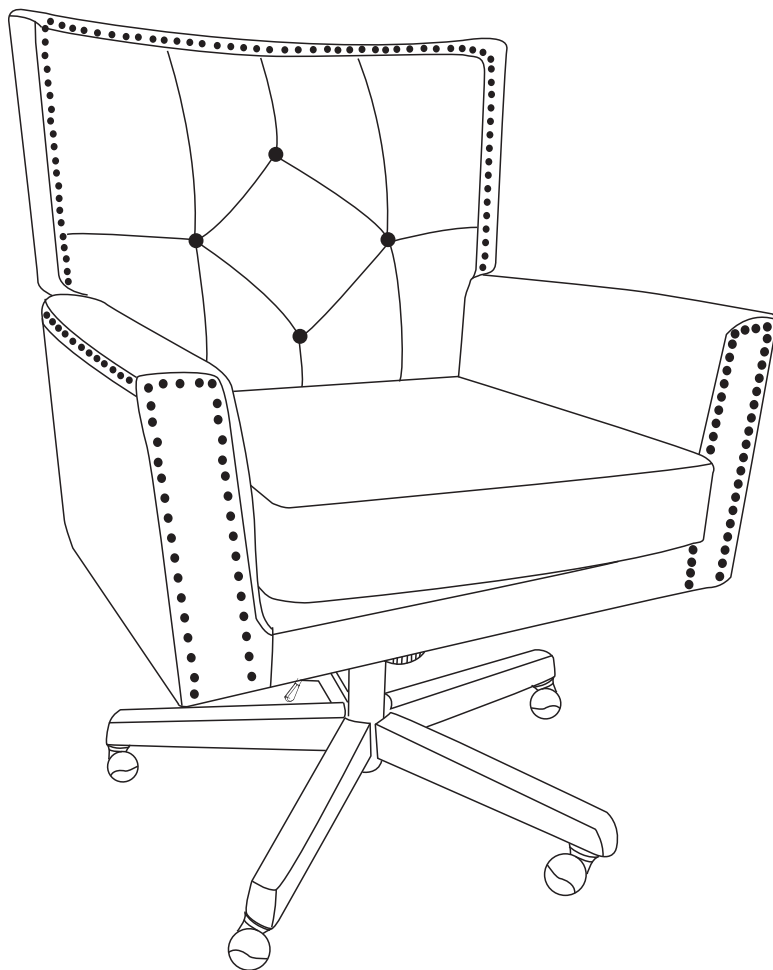

Assembly completed.

Step 7

Adjust the chair height by pulling lifting lever

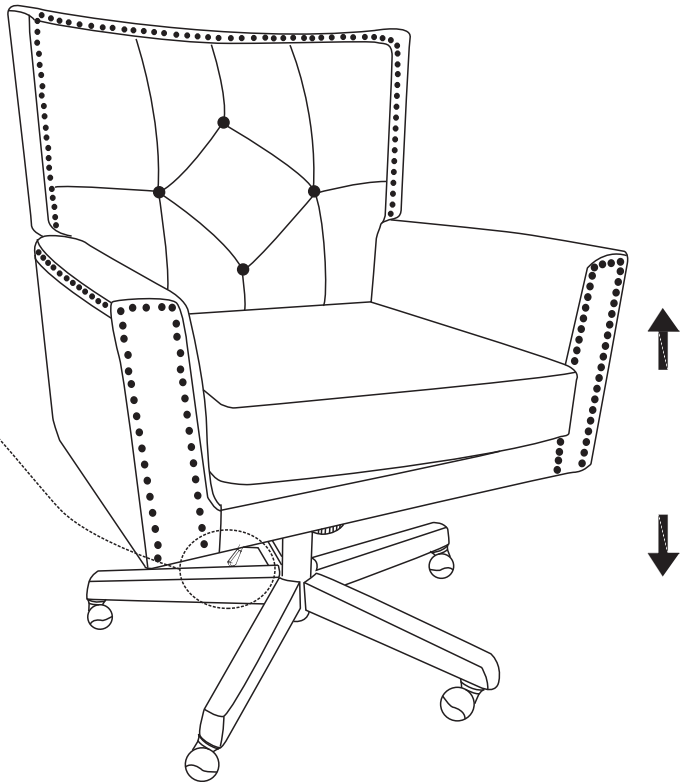
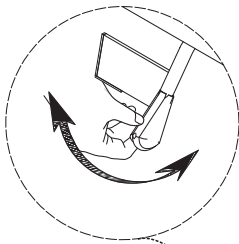

adjust forward and backward tilt angle of chair by rotating rotary knob under chair

Step 8



Rotate this knob clockwise to adjust the recline angle of the backrest; counterclockwise to adjust the backrest forward.

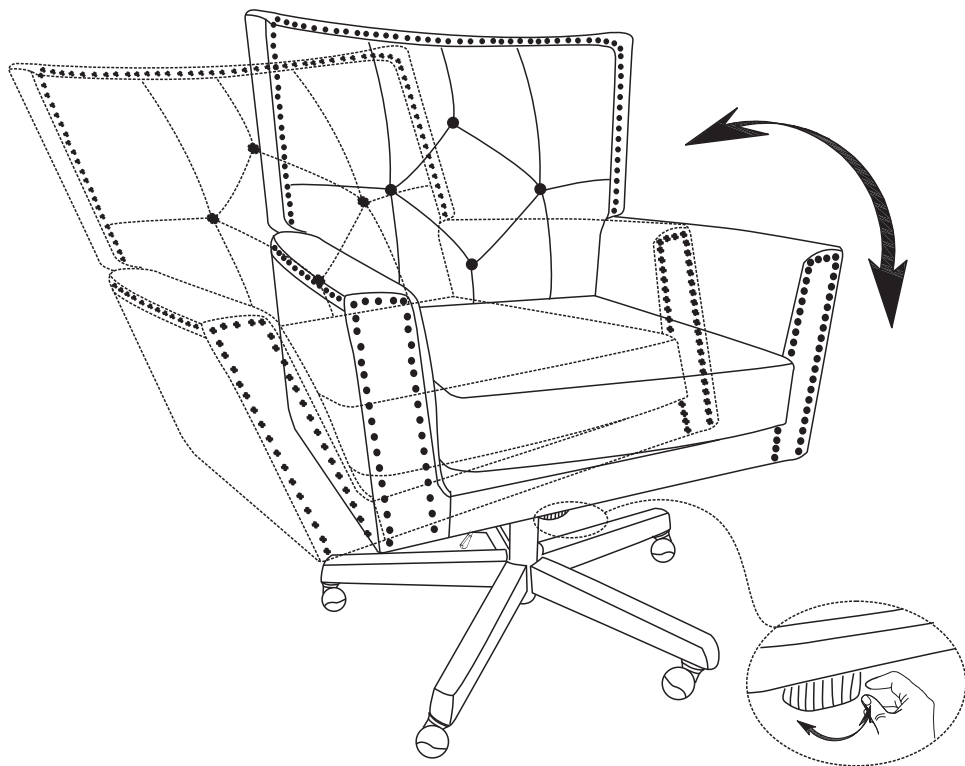

WARRANTY

- We strive to offer quality products, and we also try our best to satisfy every customer who orders from us with products or services as needed.
- Replacement parts by purchasing them from our company if they are available.
- For return, please check the return policy with the retailer or market place you bought from

Are you having difficulty

**With assembly? Missing parts?
Please send an email with your order No. to
hello@hulalahome.com**

**Appreciate your purchasing from us.
Pop up your life by our furniture piece!**