











Assembly Instructions

Caution : You must read this before you proceed

Care & Maintenance

- ⊘  ● Not for commercial use. For residential use only.
 - ✓  ● Furniture may scratch floors. We recommend using furniture pads to protect your floors.
 - ⊘  ● Do not put hot items directly on furniture surface.
 - ⊘  ● Do not clean furniture with harsh cleansers or polish.
 - ⊘  ● Do not place furniture under direct sunlight.
 - ⊘  ● Do not place furniture near heating or cooling vents.
 - ⊘  ● Do not write on furniture without a padded barrier to protect the surface.
 - ⊘  ● Do not place furniture outside . For indoor use only.
 - ⊘  ● Stains may be removed with mild soap solution and damp cloth.
 - ⊘  ● Children should not climb or jump on the furniture.
-
- ✓  ● Dust and pick-up spills using a clean, non-colored, lint-free cloth.



Please look in carton for hardware packs and legs.
Sets often ship in multiple boxes and may arrive a day or two apart.

DINING CHAIR

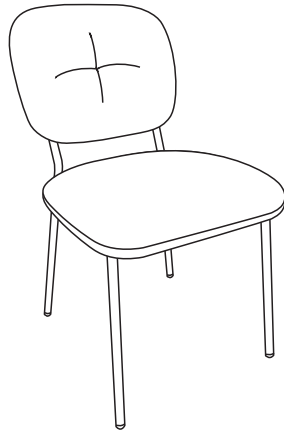



N842P284566

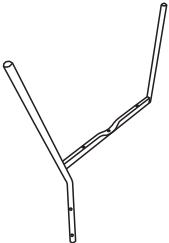
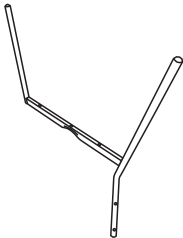

Parts List

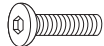
Label	Picture	Description	QTY
①		Seat Cushion	1
②		Seat Cushion	1
③		Leg	1
④		Leg	1

Hardware

Label	Picture	Description	QTY
A		Bolt (M6x45mm)	4
B		Bolt (M6x25mm)	1
C		Bolt (M6x25mm)	4
D		Washer (6x16x1.5mm)	5
E		Allen Wrench (M4)	1
F		Allen Wrench (M5)	1

Assembly Preparation

Before Beginning Assembly :

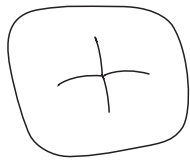

①

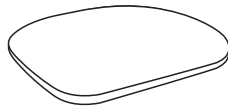

②

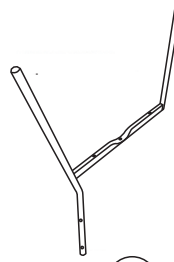

③

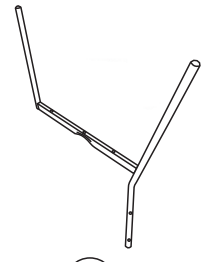

④

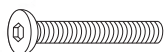

Ⓐ x 4

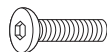

Ⓑ x 1

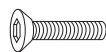

Ⓒ x 4



Ⓓ x 5



Ⓔ x 1



Ⓕ x 1



- Read instructions, cover to cover-



- Have 2 adults on hand for assembly-



- Do not assemble on flooring or carpet-



- Assemble on a clean non-marring surface (packing foam)-



- Save all packaging until finished-

Assembly Steps

Overview

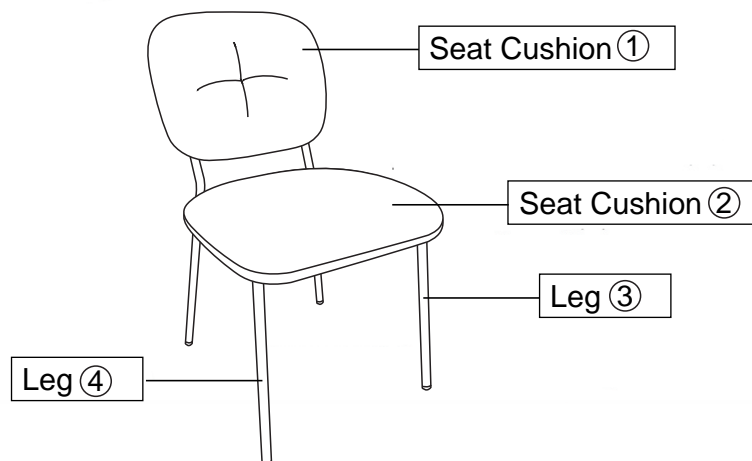

This Chair consists of multiple parts and may take up to 30 minutes to assemble. The picture above provides an overview of the Chair parts to help you visualize and understand each component. Before you start assembling, please read through the instructions below to familiarize yourself with the parts and steps.

Step1

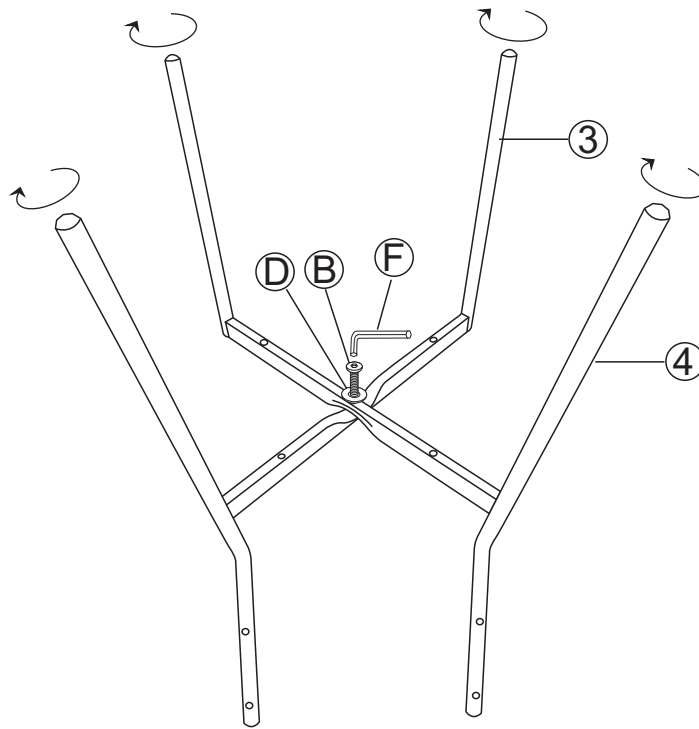

Cross and assemble legs ③ and ④ using the Allen Wrench ⑆, Bolt ⑂, and Washer ⑄ .

Step2

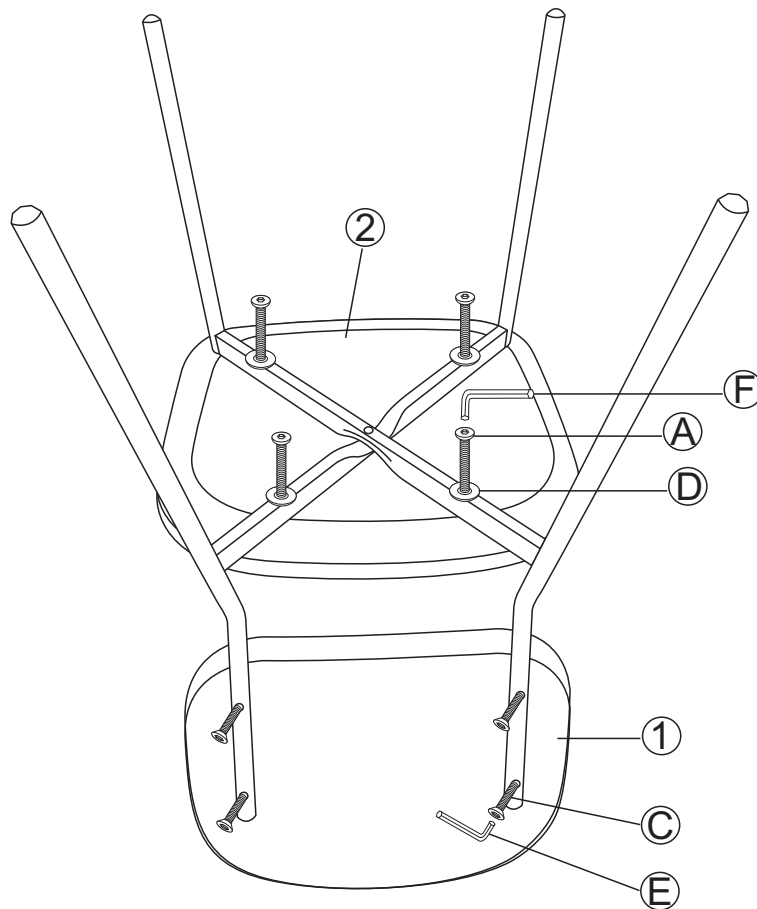

Attach the leg to seat ② using the Allen Wrench ⑆, Bolt ⑁, and Washer ⑄ .
Attach the leg to back ① using the Allen Wrench ⑅ and Bolt ⑃ .

Step3

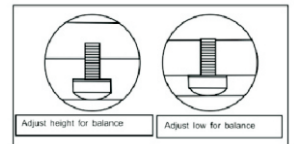
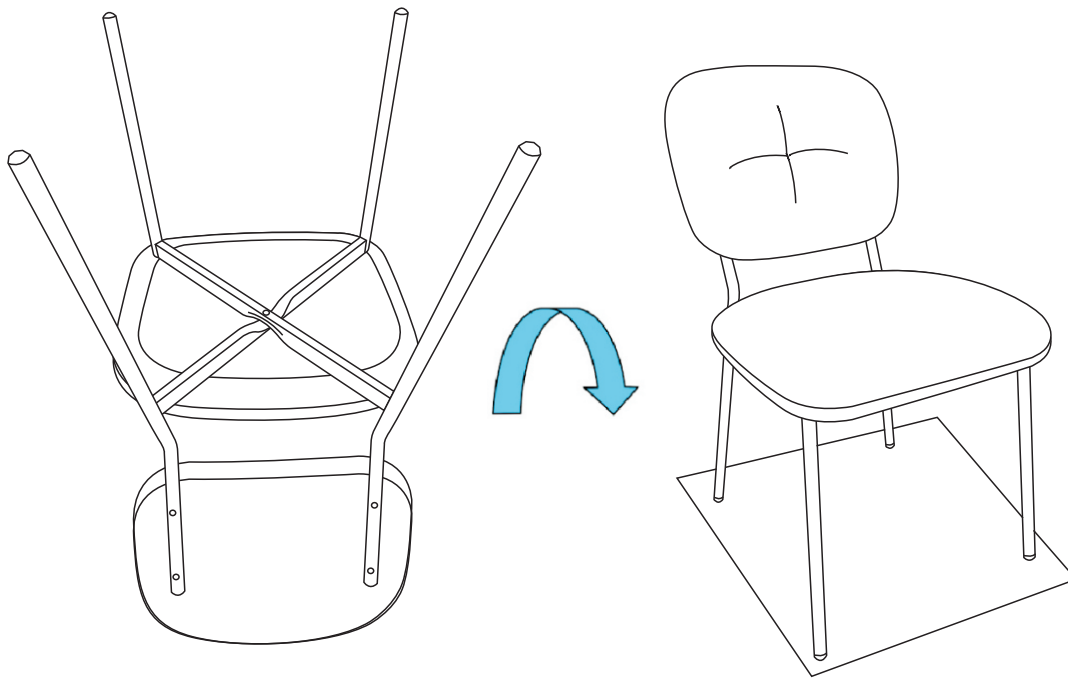

Stand the chair up.
Place the chair on a level surface to check for wobbles.
Adjust the levelers to ensure chair stability.

Step4

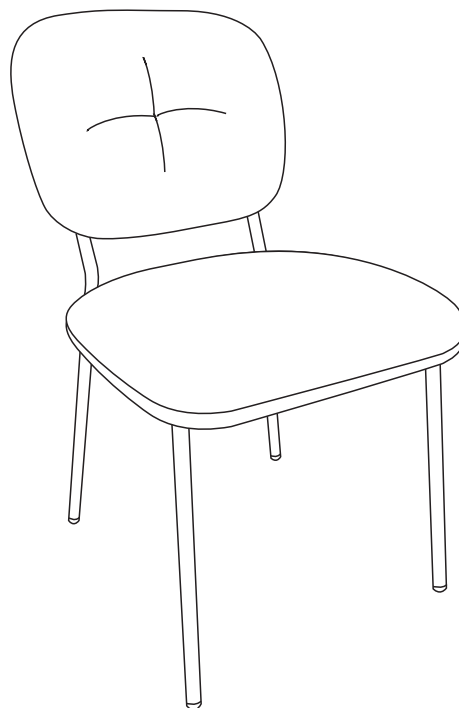

The chair is ready for use.
The chair can only be used on a flat, level surface.