

# ASSEMBLY INSTRUCTIONS

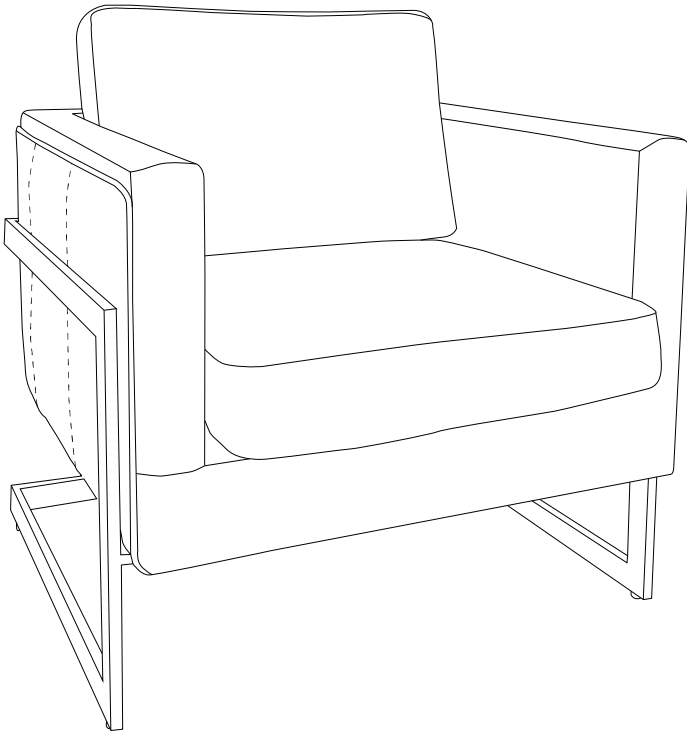

**LEATHER SOFA**

# SPARE PARTS

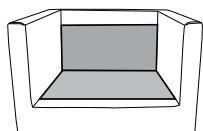

**Ax1**

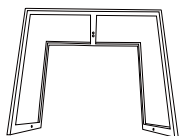

**Bx1**



**Cx1**

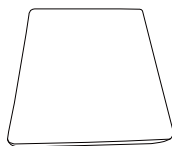

**Dx1**

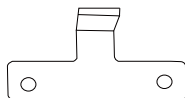

**Ex1**



**Fx1**



**M6 × 35mm**

**Hx2+1extra**



**M6 × 25mm**

**Ix2+1extra**



**M6 × 18mm**

**Jx2+1extra**



**M6 × 16mm**

**Kx2+1extra**



**( $\Phi 6 + \Phi 18$ ) \* 1.5mm  
M6**

**Lx8+1extra**



**M6**

**Mx1**

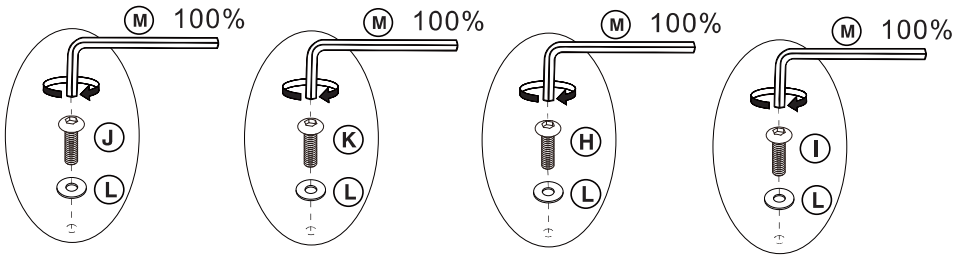

Adjust to horizontal

If the foot is still not stable after installation, adjust the front leg nail to adjust

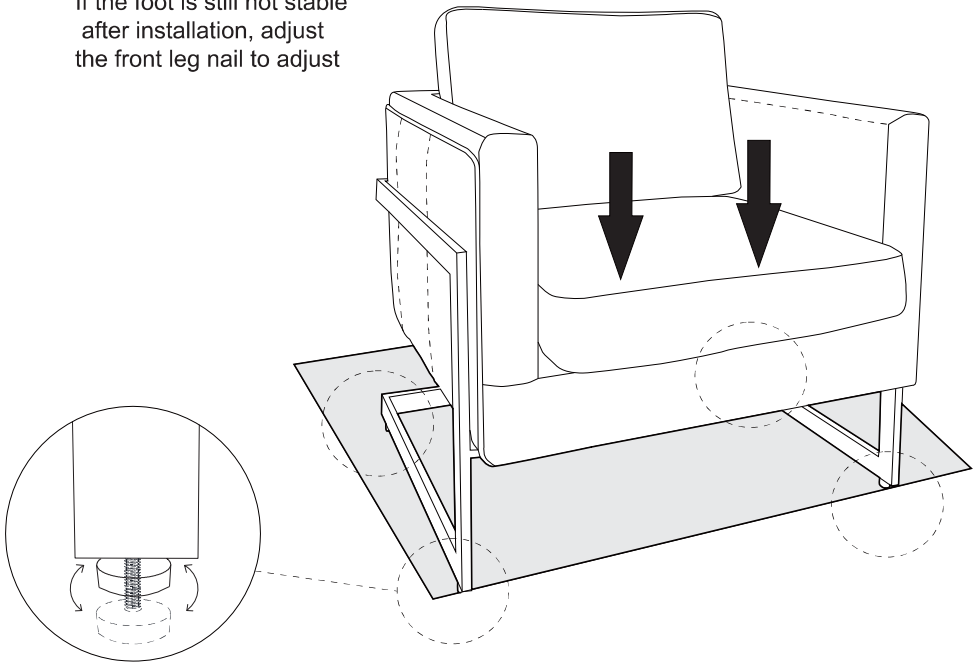

# 1



Bx1



Ex1



Fx1



M6×18mm  
J x2



M6×16mm  
K x2



(Φ6+Φ18) \*1.5mm  
M6  
Lx4

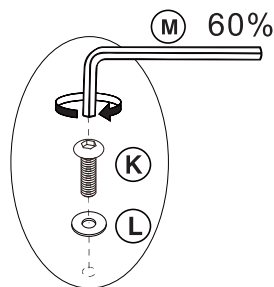
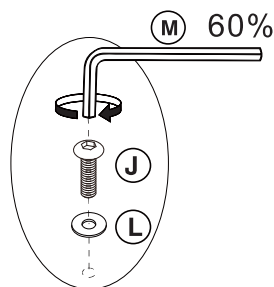
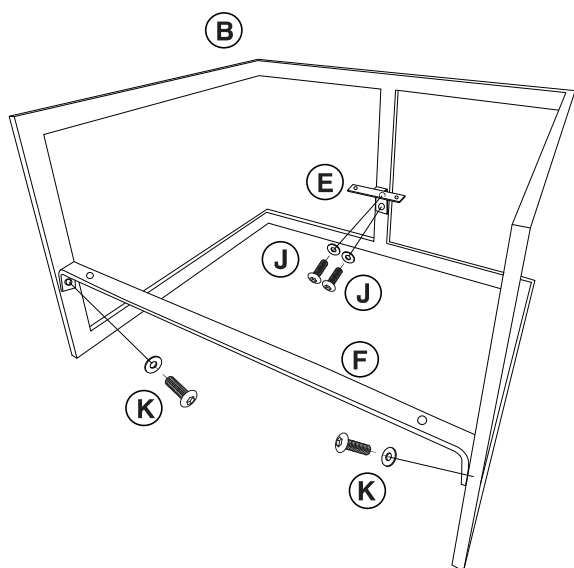

# 2

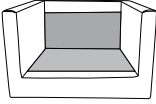

Ax1

A

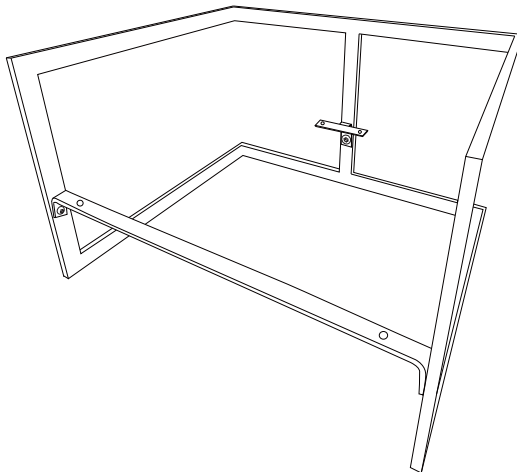
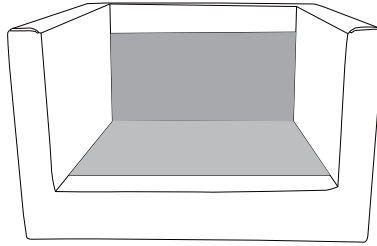

# 3



M6 × 35mm  
Hx2



M6 × 25mm  
I x2



(Φ6+Φ18) \*1.5mm  
M6  
Lx4

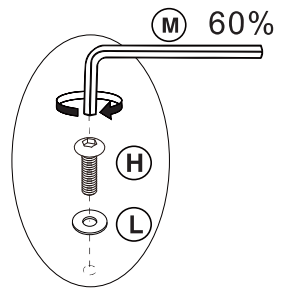
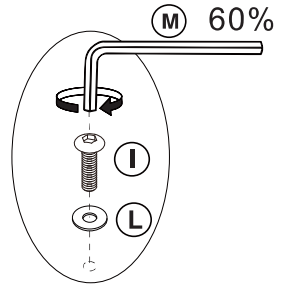
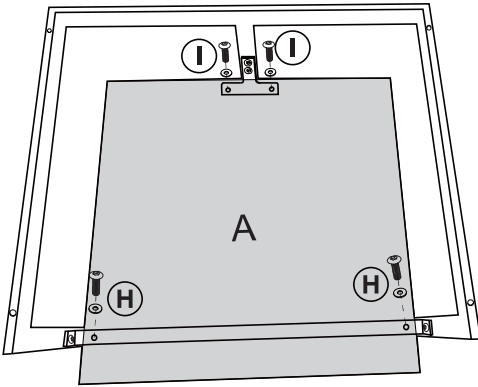

# 4



Cx1

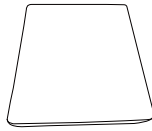

Dx1

