

WARNING!

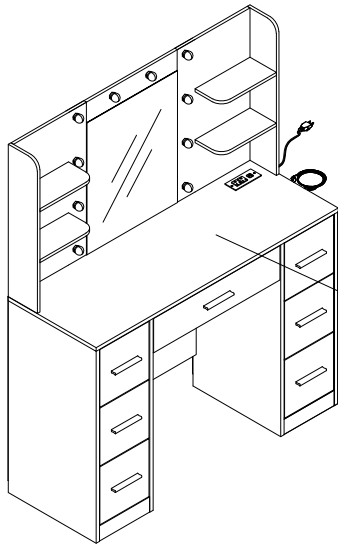

MAXIMUM LOAD
220 lb/100kg

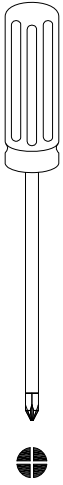
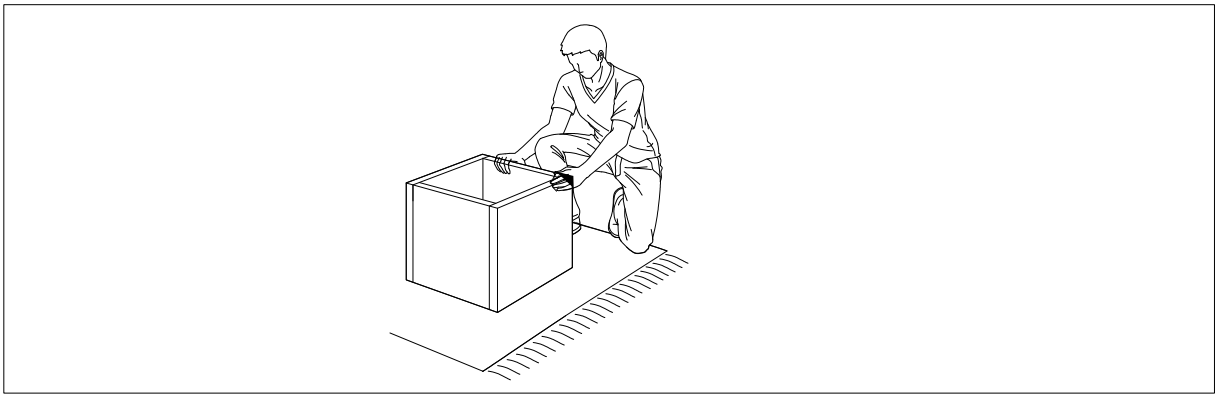

Assemble the furniture on empty carton, carpet, or rug to prevent scratches or damage.

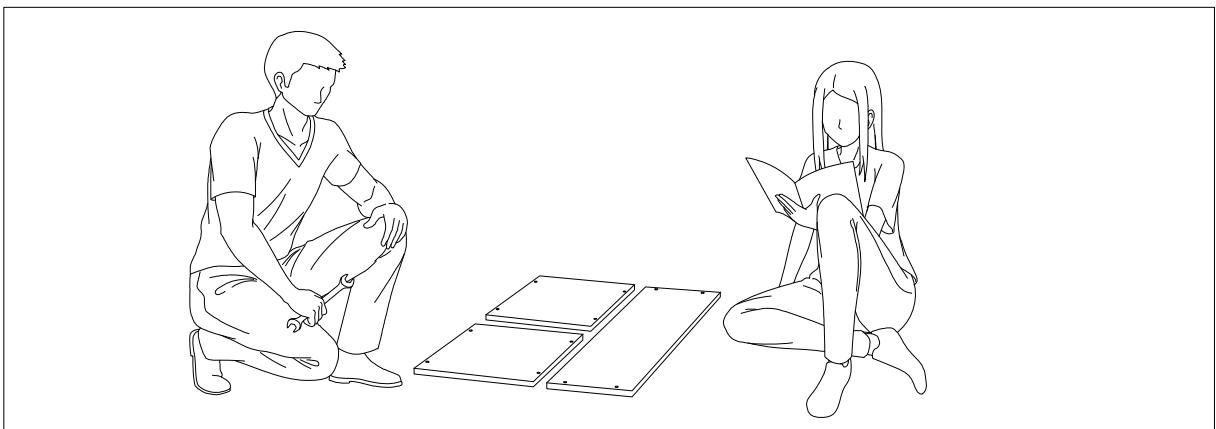

This furniture requires 2 people to assembly.
Make sure no parts are missing or damaged before assembly.

Not actual size

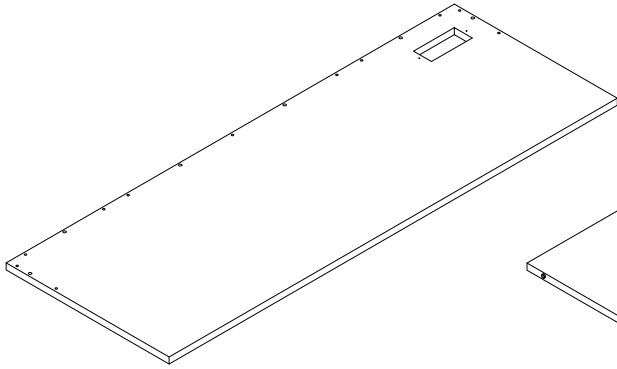

① X1

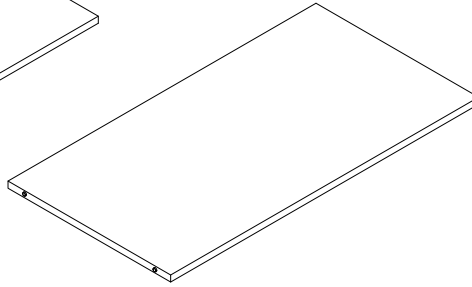

② X1

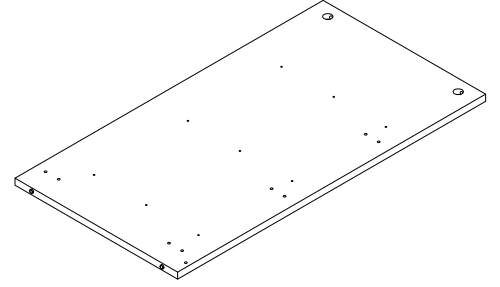

③ X1

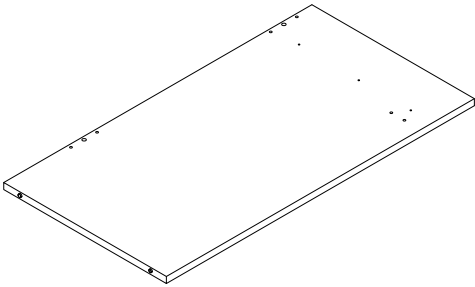

④ X1

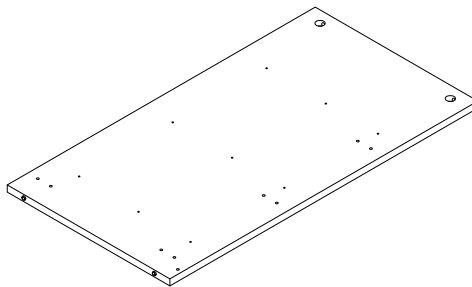

⑤ X1

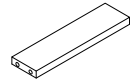

⑥ X4

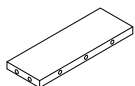

⑦ X2

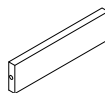

⑧ X2

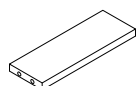

⑨ X2

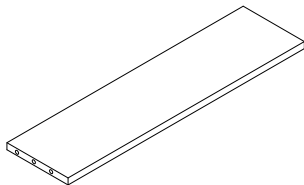

⑩ X1

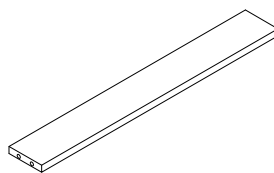

⑪ X1

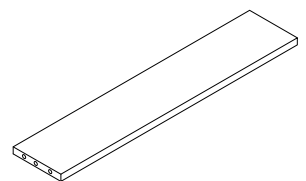

⑫ X1

BOARD IDENTIFICATION

Not actual size

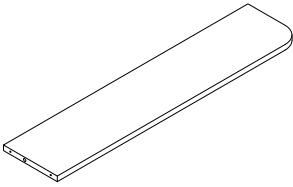

⑬ X1

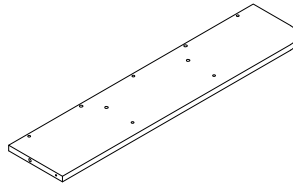

⑭ X1

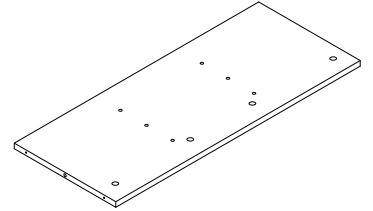

⑮ X1

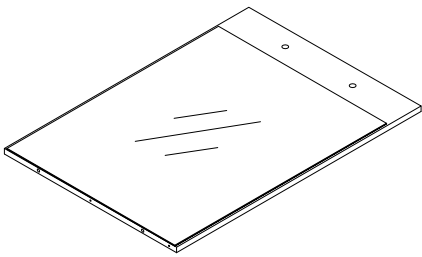

⑯ X1

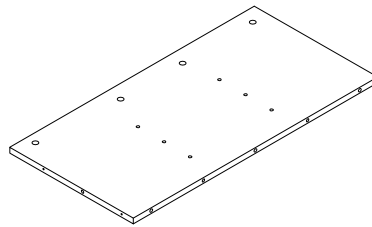

⑰ X1

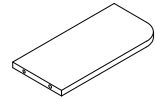

⑱ X2

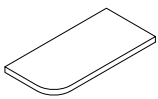

⑲ X2

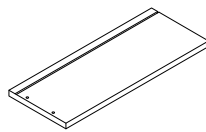

⑳ X6

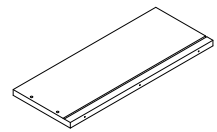

㉑ X6

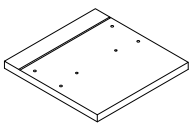

㉒ X6

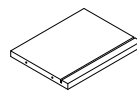

㉓ X6

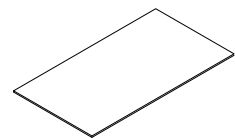

㉔ X6

BOARD IDENTIFICATION

Not actual size

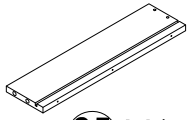

②5 X1

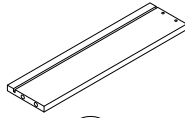

②6 X1

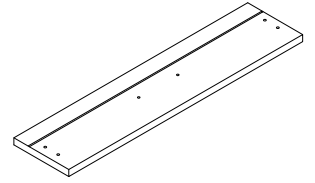

②7 X1

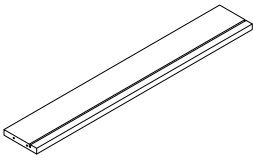

②8 X1

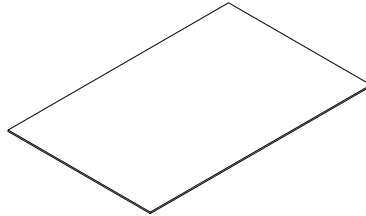

②9 X1

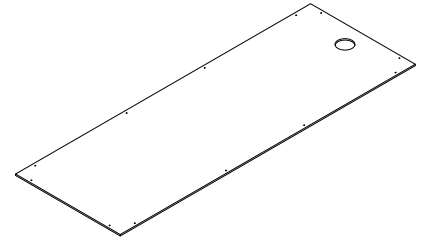





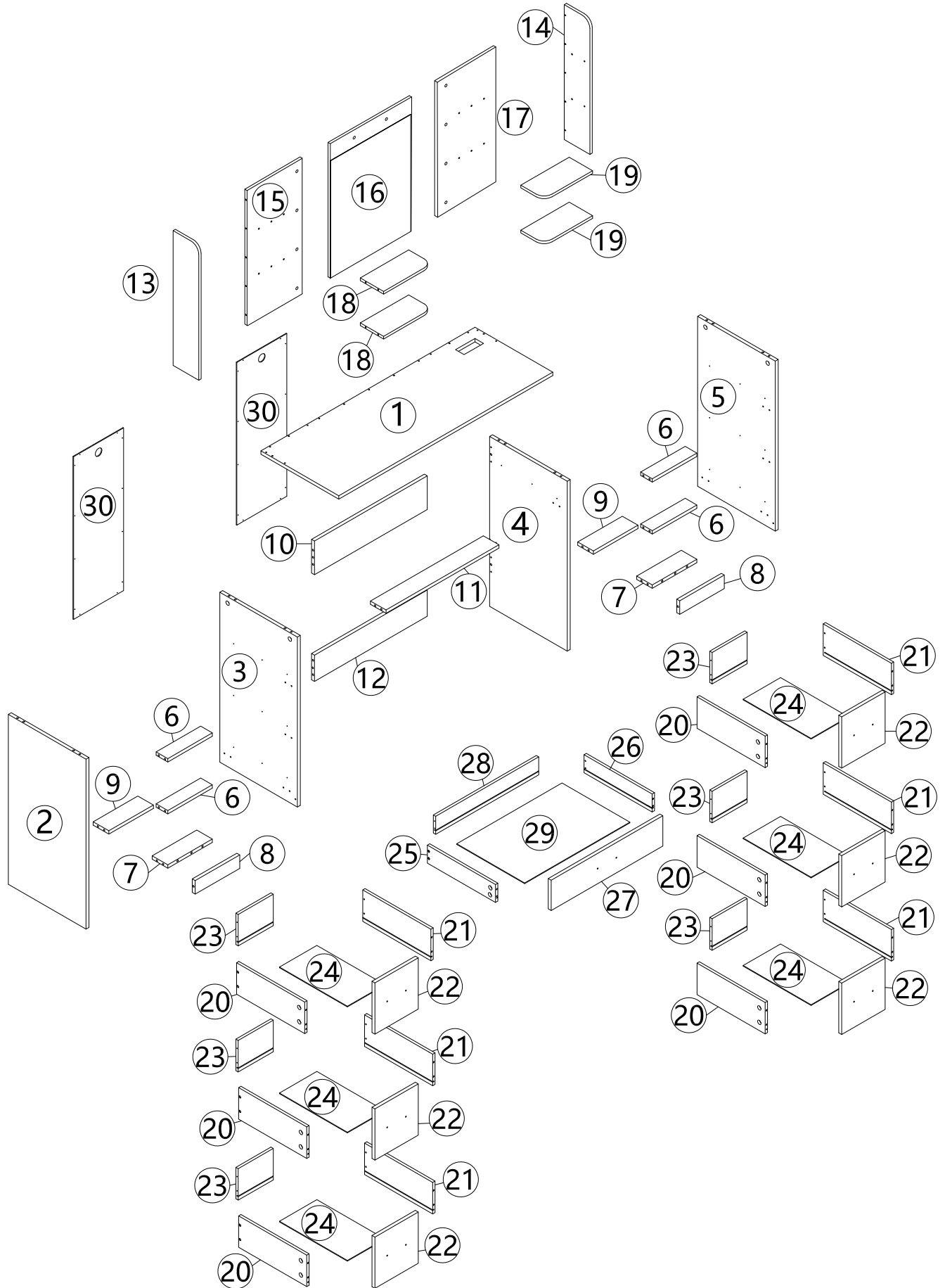



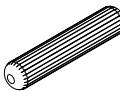
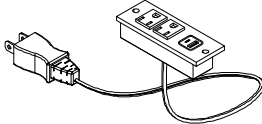

③0 X2

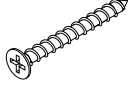
PACKAGE CONTENT

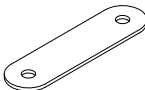
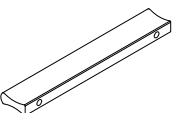

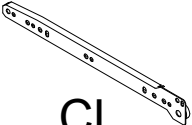
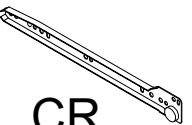
HARDWARE PART LIST

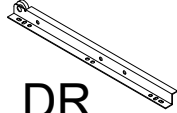
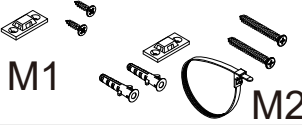
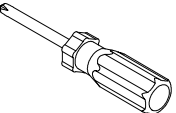
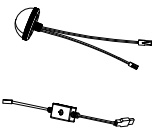
<p>A X104+3</p>  <p>Ø6x34</p>	<p>B X104+3</p>  <p>Ø15x9.5</p>	<p>C X34+2</p>  <p>Ø6x30</p>	<p>D X1</p> 
<p>E X98+3</p>  <p>Ø3.5x12</p>	<p>F X39+2</p>  <p>Ø4x35</p>	<p>G X26+2</p>  <p>Ø3.5x14</p>	<p>H X6</p>  <p>45x15x1</p>
<p>I X7</p>  <p>Ø106x16x8</p>	<p>J X14</p>  <p>5/32"x16</p>	<p>K X1</p>  <p>109x99*38,5</p>	
<p>L X7</p>     <p>CL CR DL DR</p> <p>L=350</p>			
<p>M X1set</p>  <p>M1 M2</p>	<p>N X1</p> 	<p>O X10+2</p> 	

Cam Lock Fastening System

Insert the cam bolt into the hole first, then insert the cam lock and lock it.

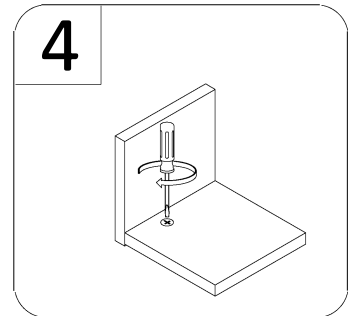
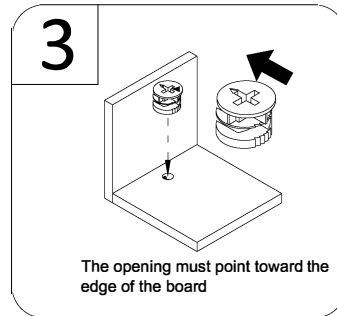
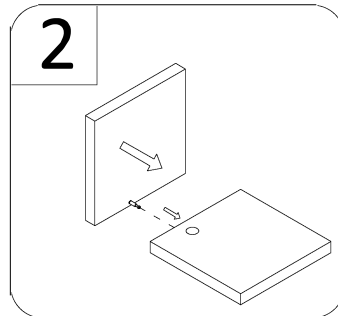
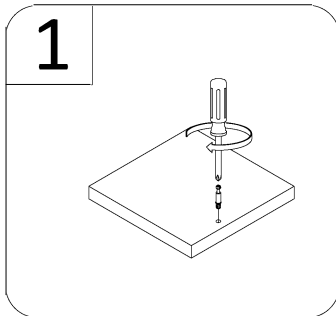

STEP 1

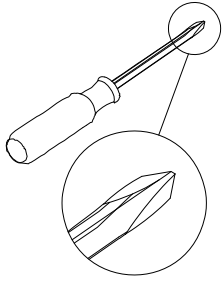

(E)	X18
	
Ø3.5x12	

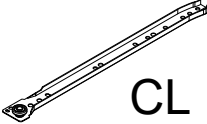
(L)	X3
	
CL L=350	

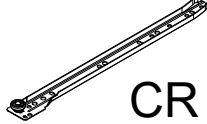
(L)	X3
	
CR L=350	

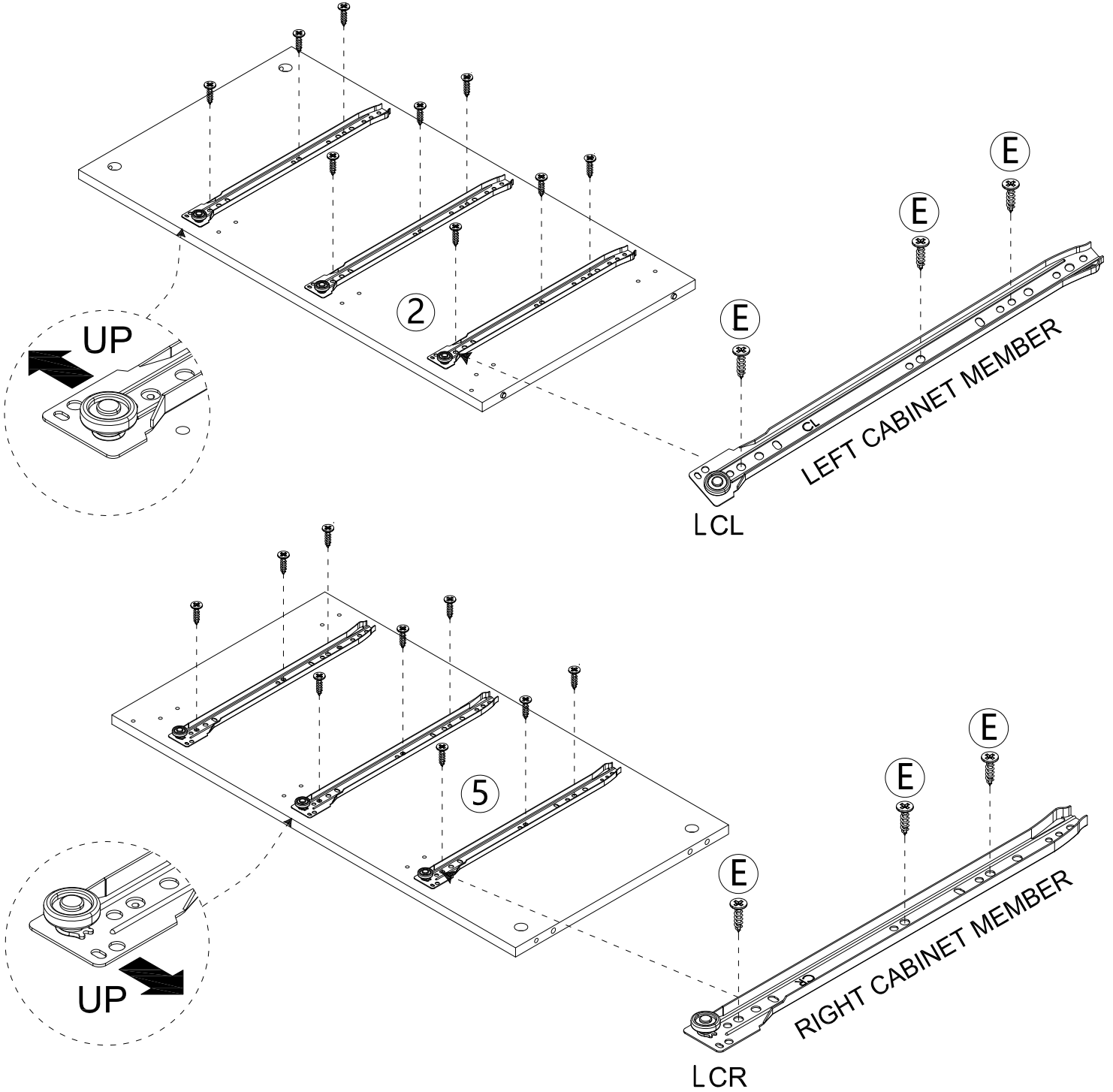

STEP 2

(A)	X18
	
Ø6x34	

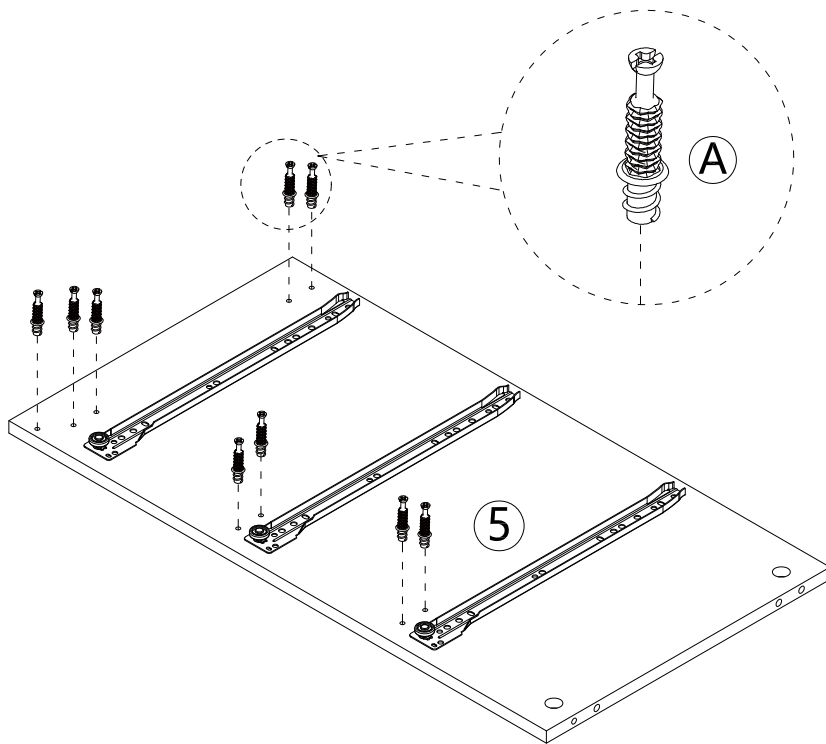
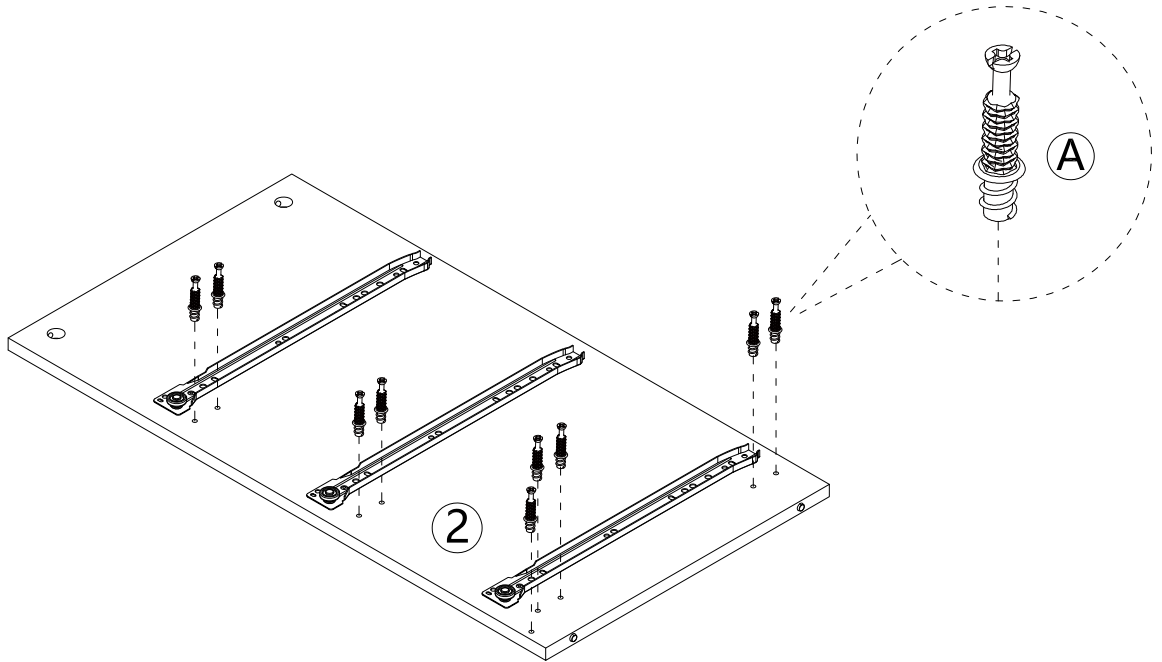
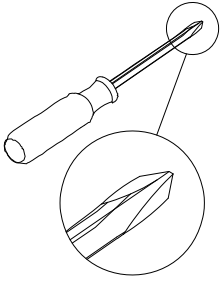

STEP 3

(E)	X12
	
Ø3.5x12	

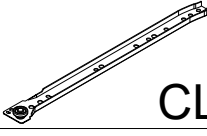
(L)	X1
	
CL L=350	

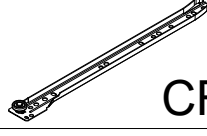
(L)	X3
	
CR L=350	

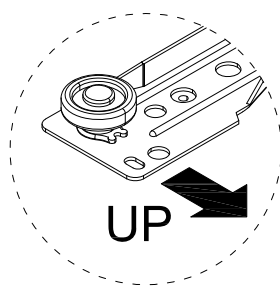
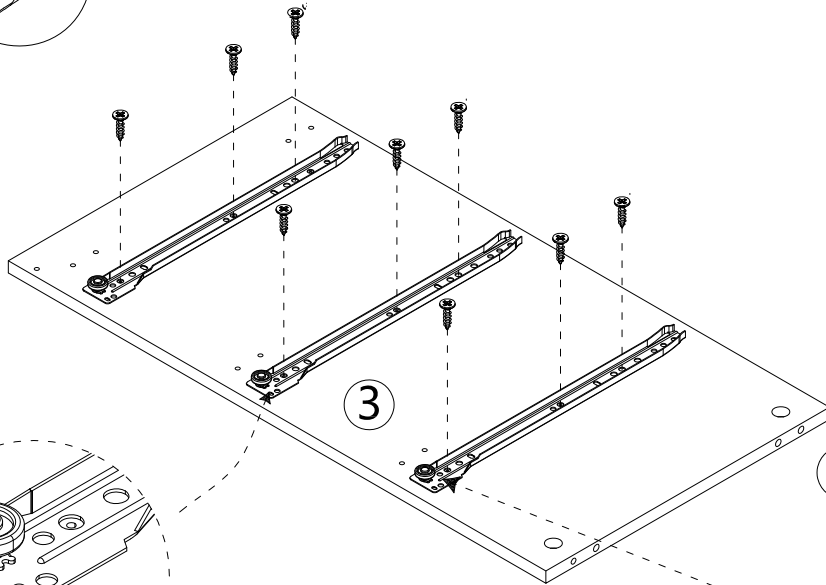
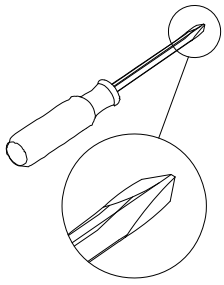

FLIP OVER



A large black curved arrow indicates the cabinet panel should be flipped over.

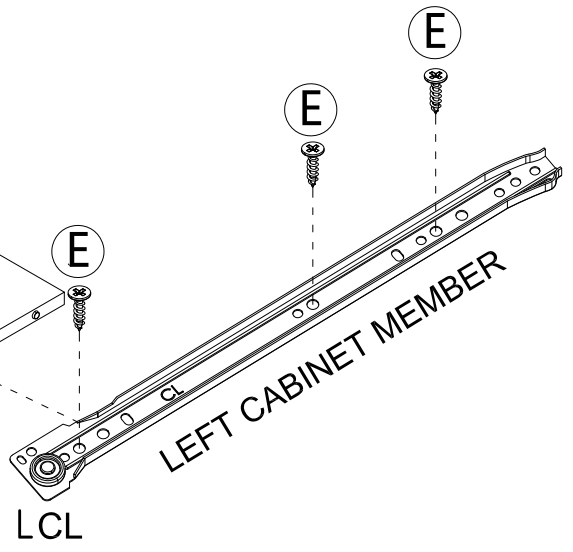
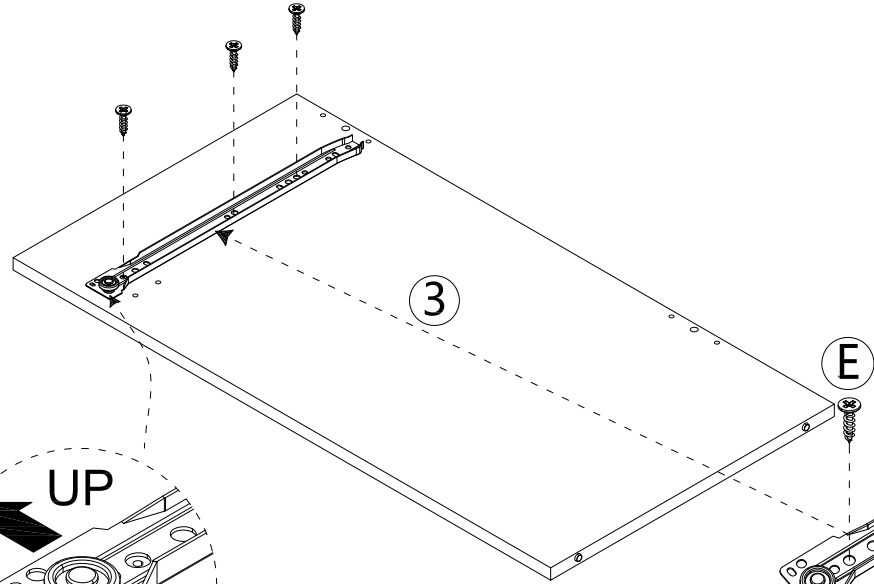
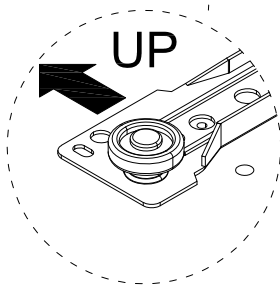
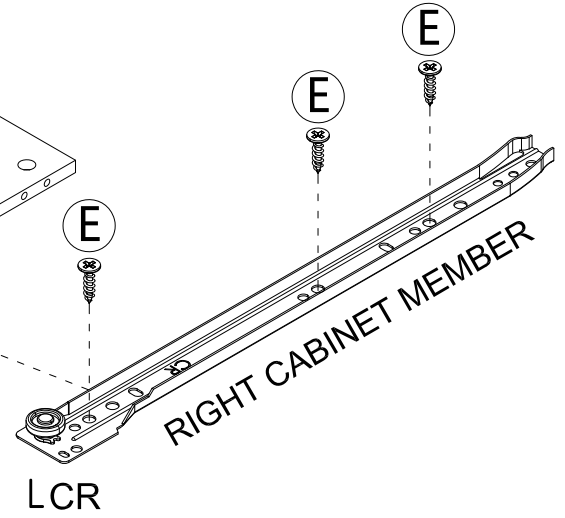

STEP 4

(A)	X15
	
Ø6x34	

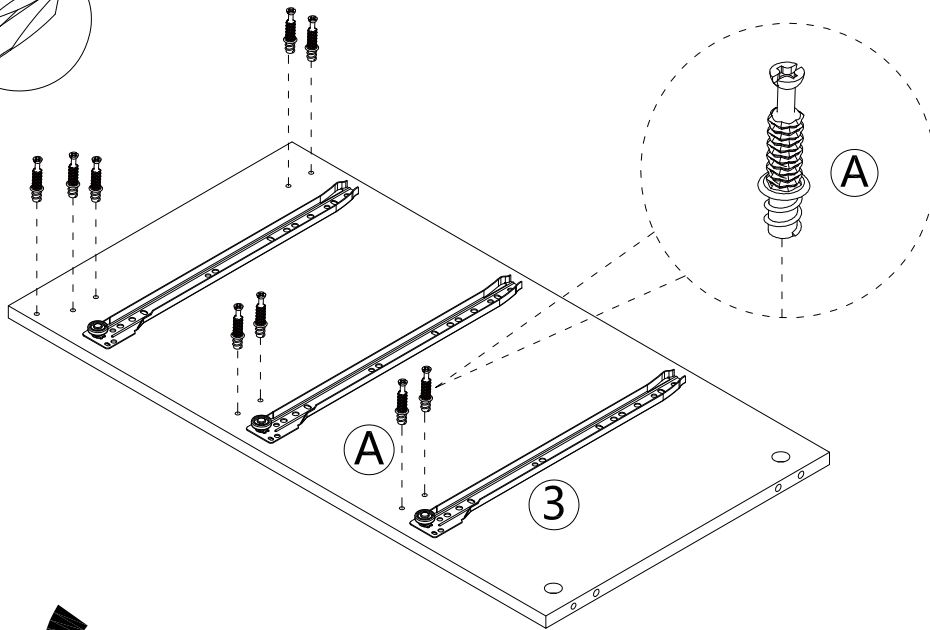
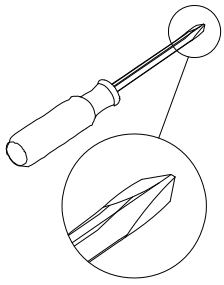

 FLIP OVER

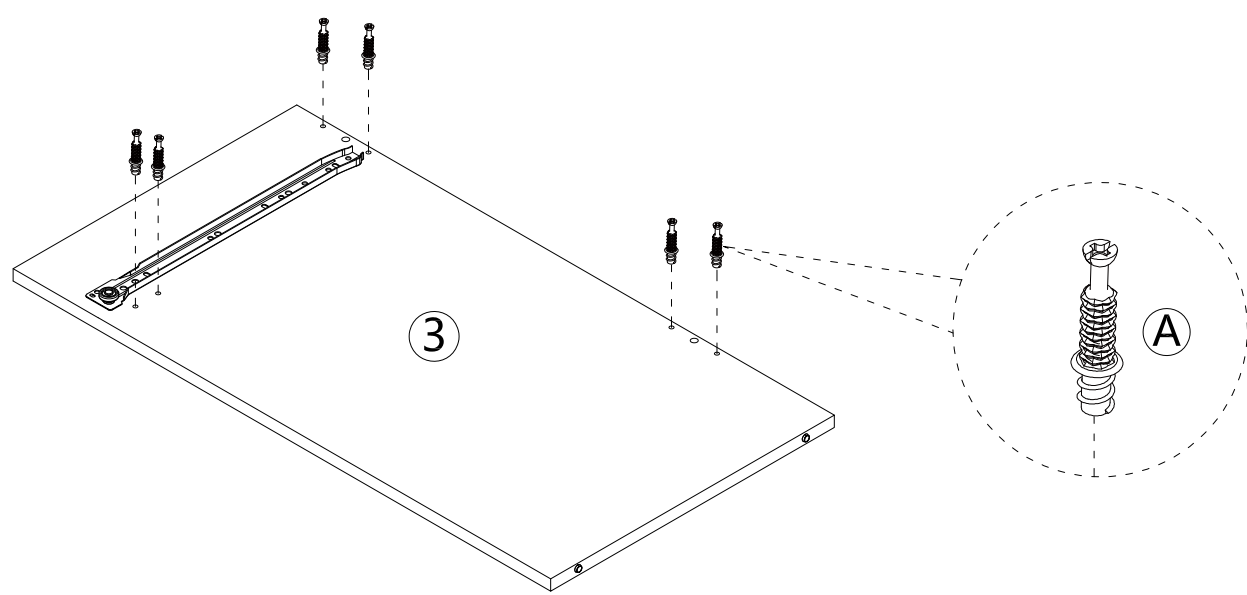

STEP 5

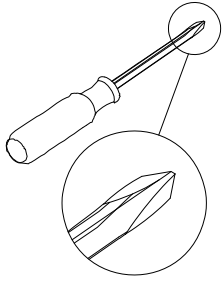

(E)	X12
	
Ø3.5x12	

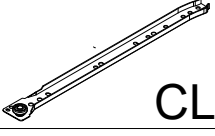
(L)	X3
	
CL L=350	

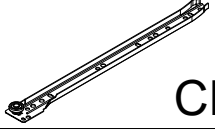
(L)	X1
	
CR L=350	

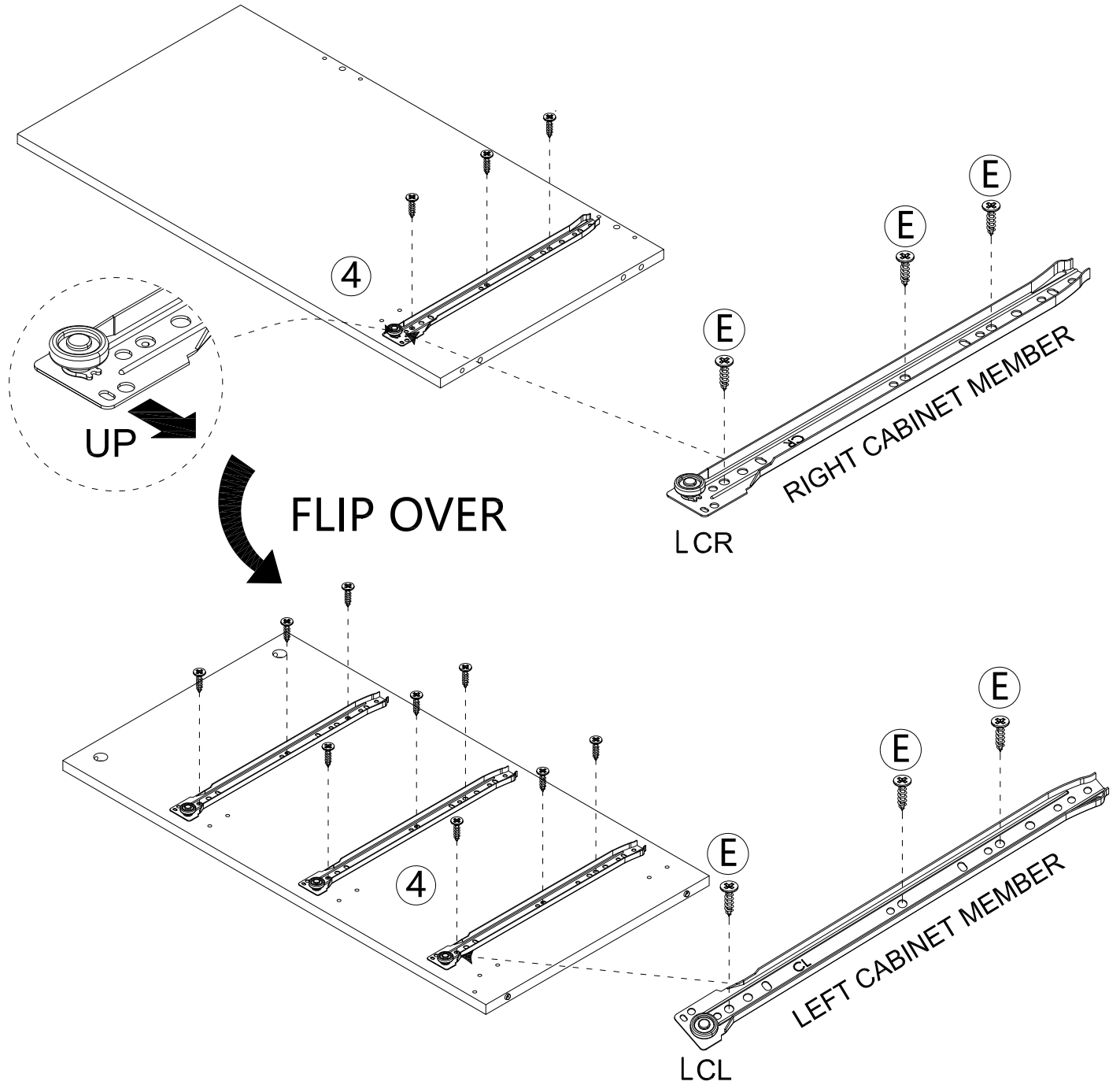

STEP 6

(A)	X15
	
Ø6x34	

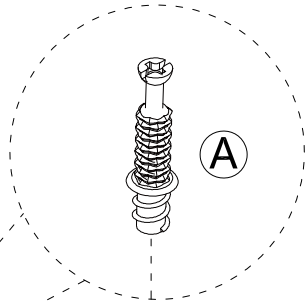
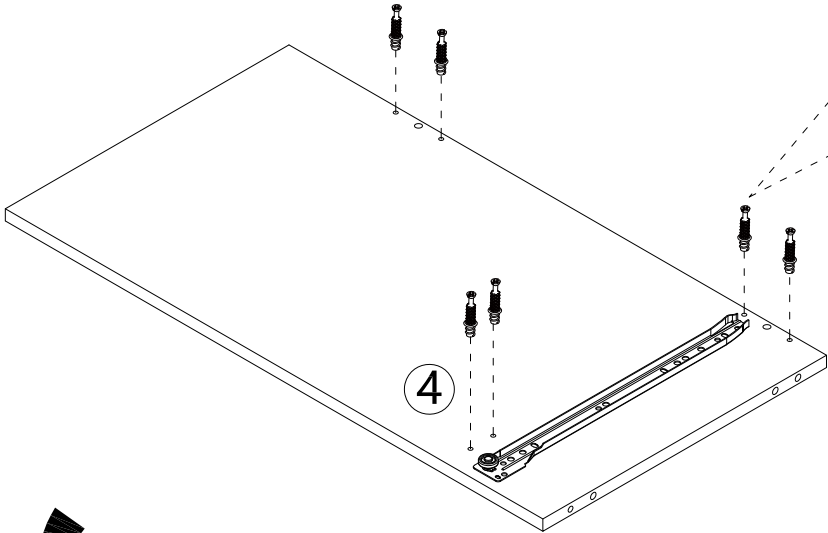
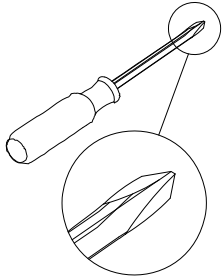

FLIP OVER

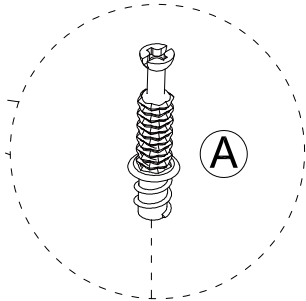
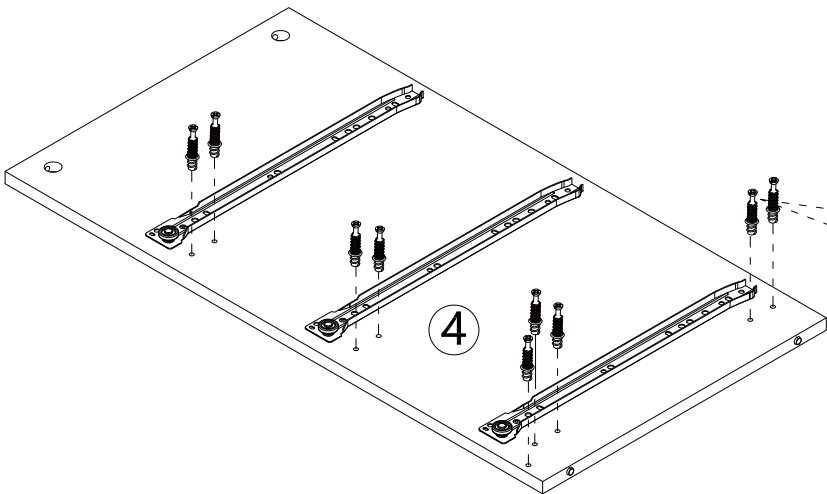

STEP 7

(A)	X2
	
Ø6x34	

(B)	X2
	
Ø15x9.5	

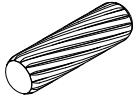
(C)	X4
	
φ6*30	

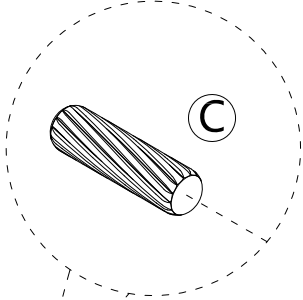
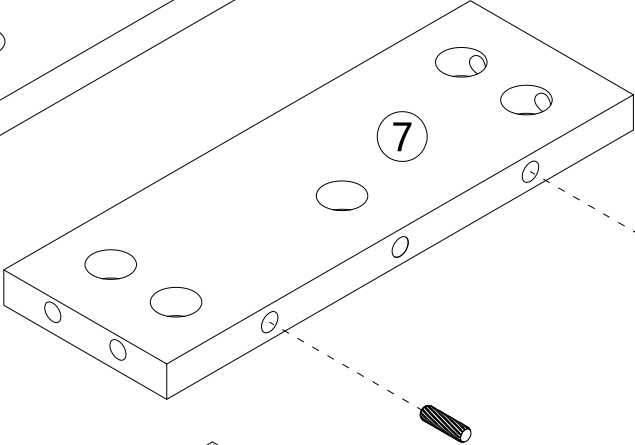
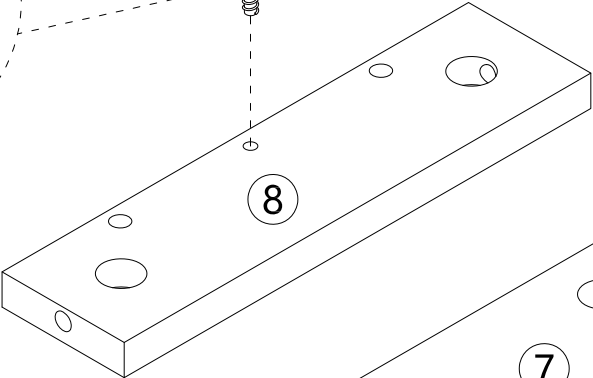
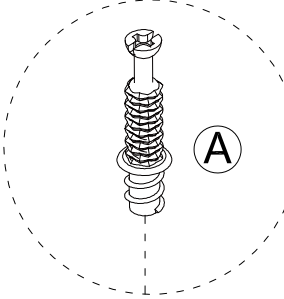
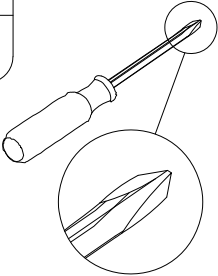

FLIP OVER

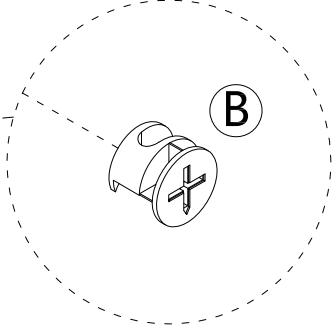
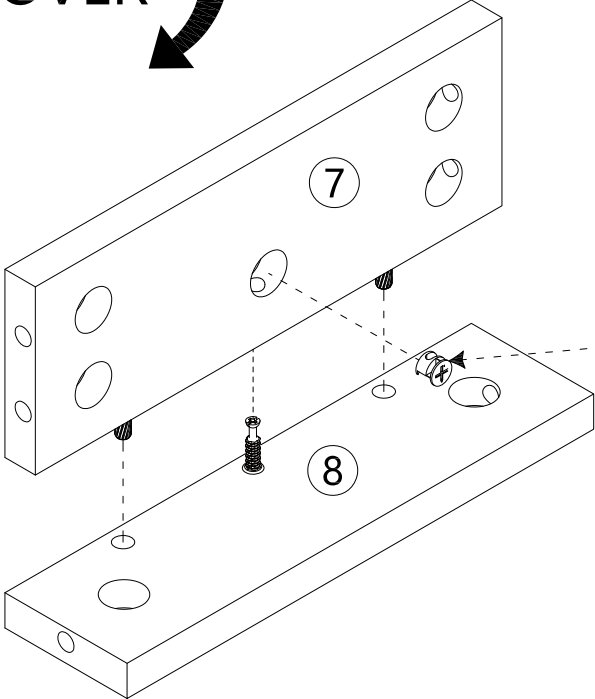

X 2

STEP 8

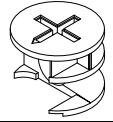
(B)	X18
	
Ø15x9.5	

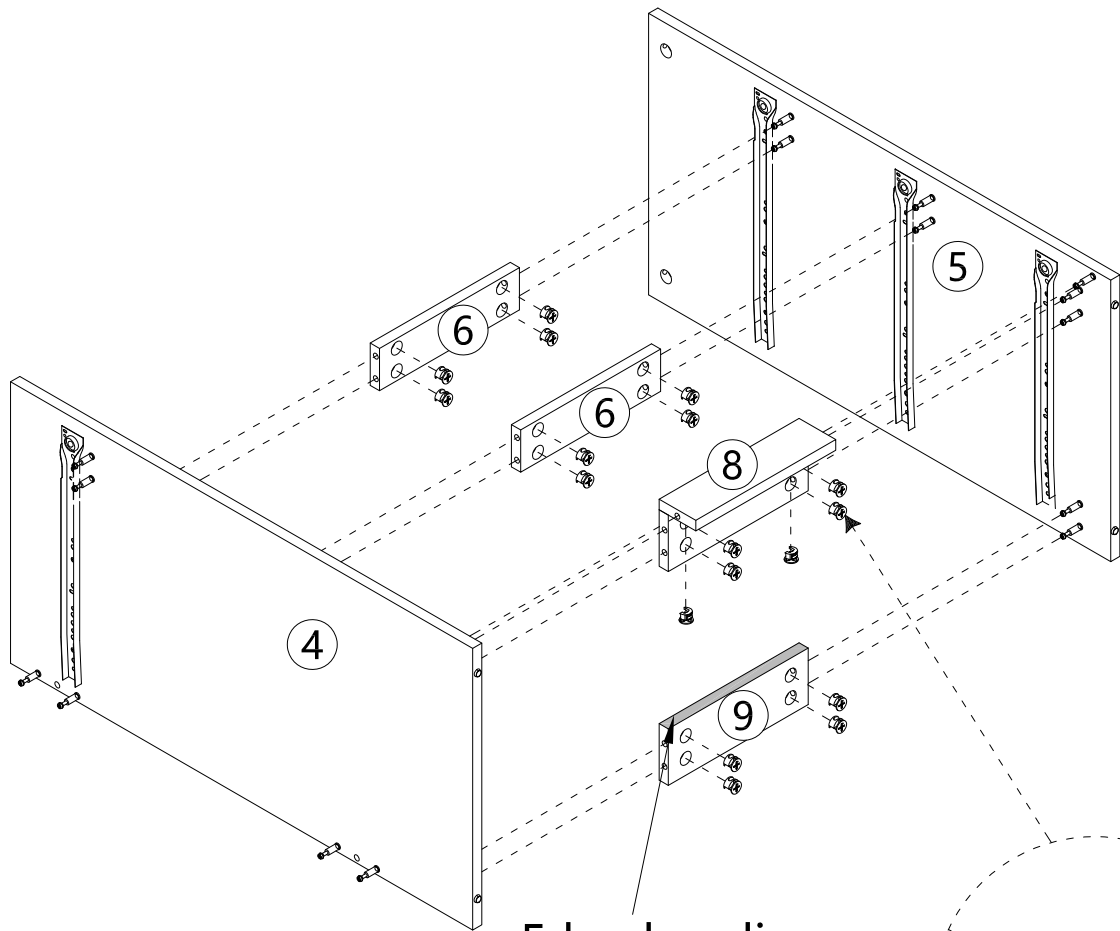
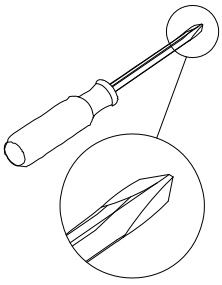

Edge banding

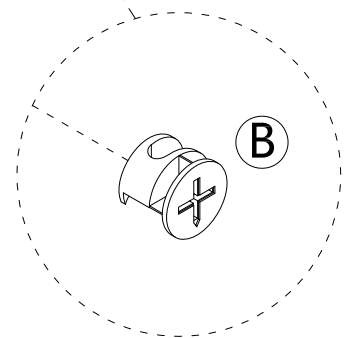

STEP 9

(B)	X18
	
Ø15*9.5	

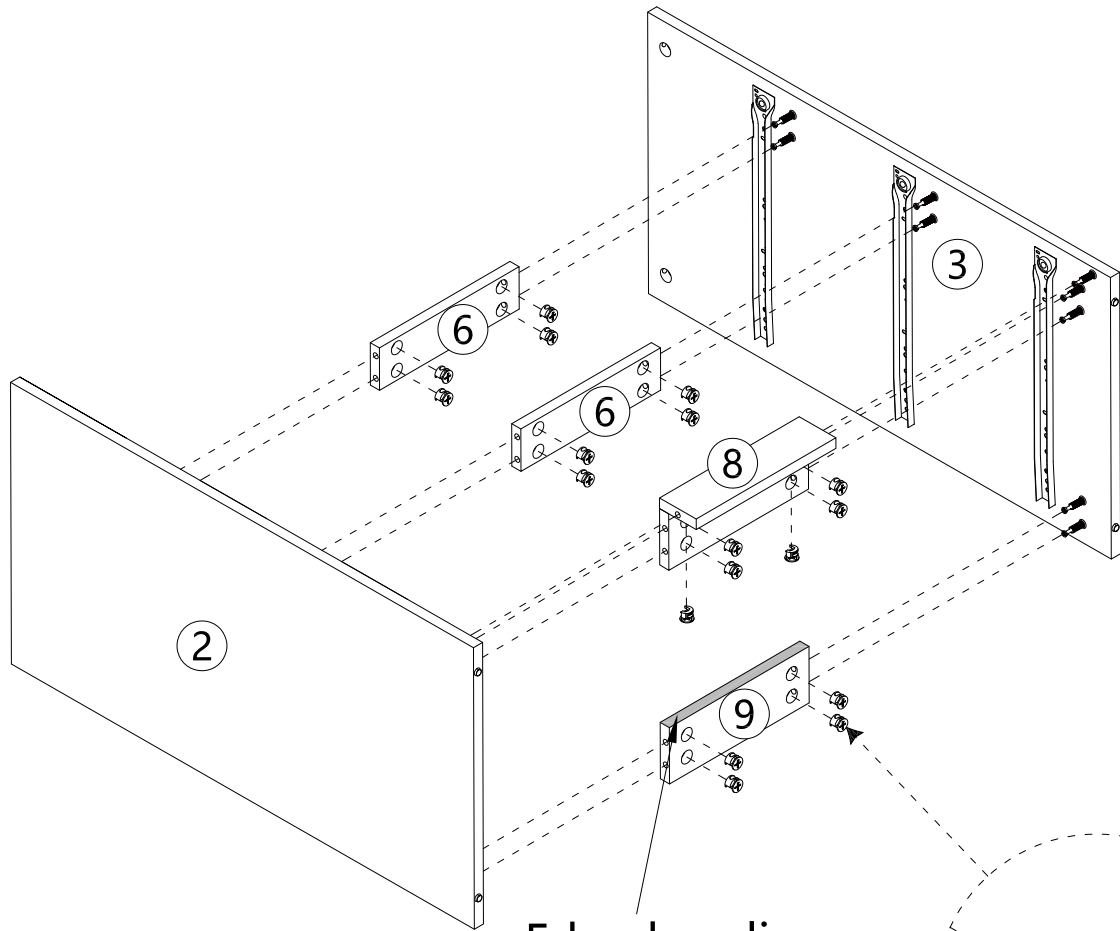
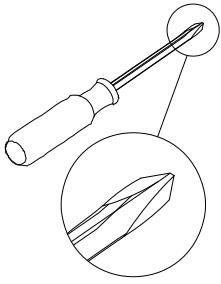

Edge banding

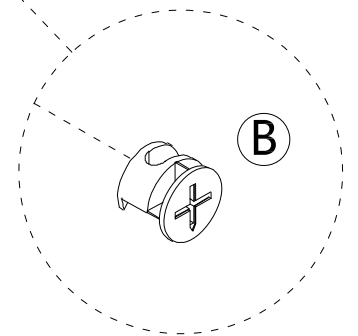

STEP 10

B	X12
	
$\phi 15 * 9.5$	

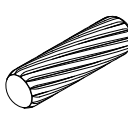
C	X4
	
$\phi 6 * 30$	

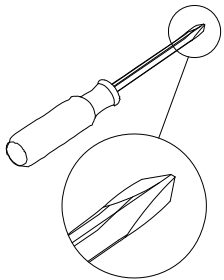

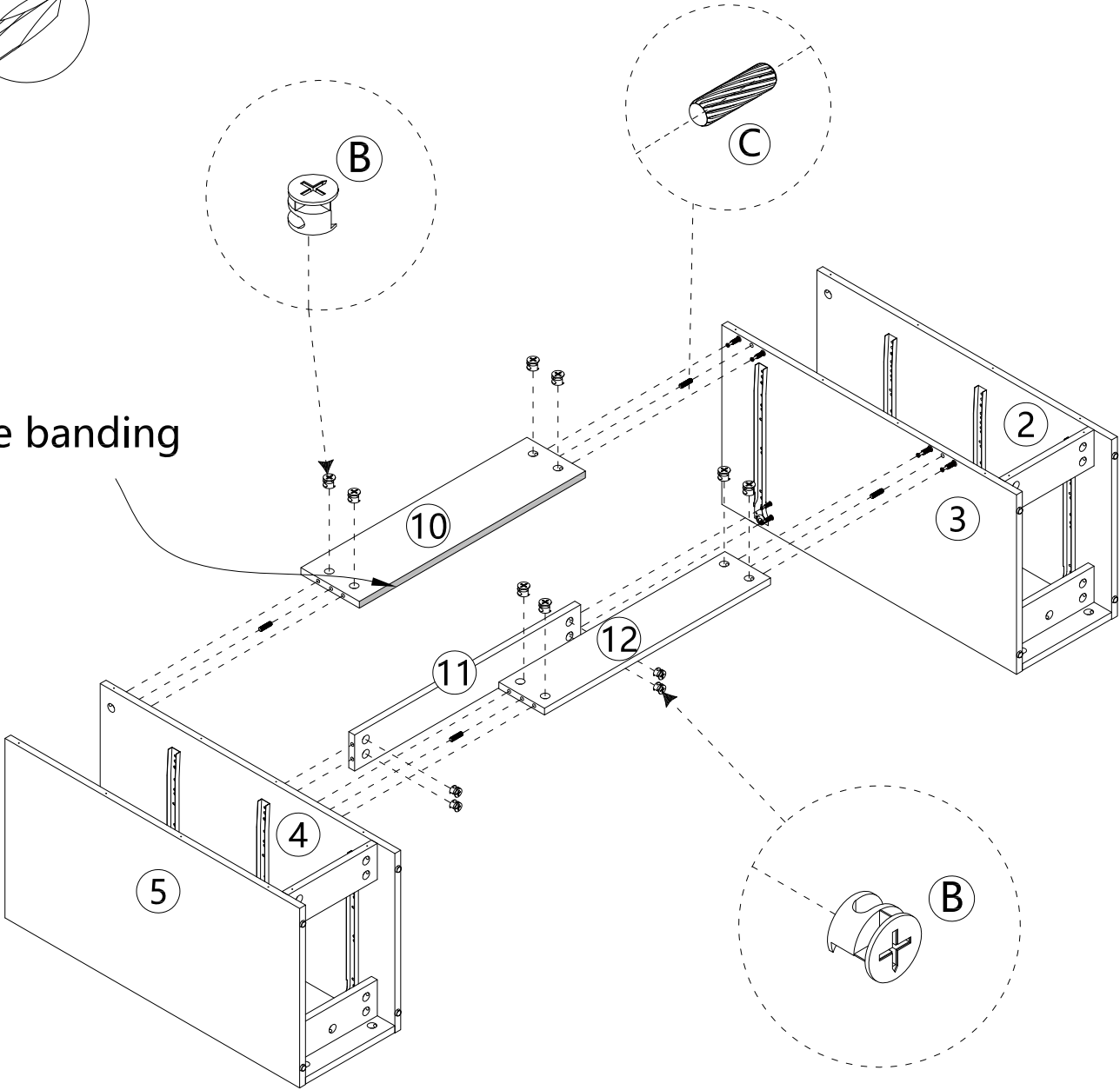

Edge banding

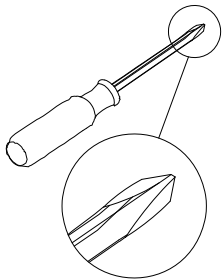

STEP 11



(A)	X9
	
Ø6x34	

(B)	X4
	
φ15*9.5	

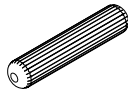
(C)	X2
	
φ6*30	

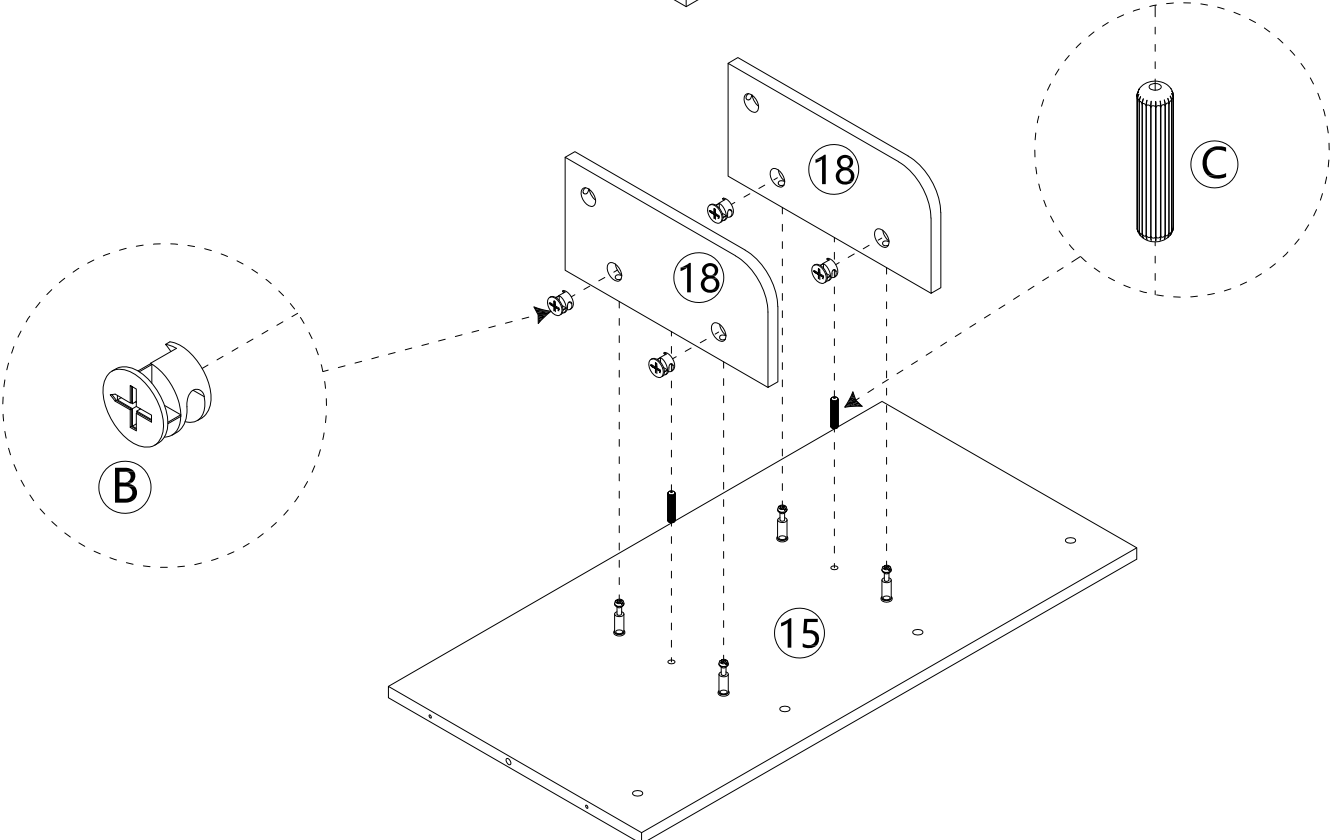
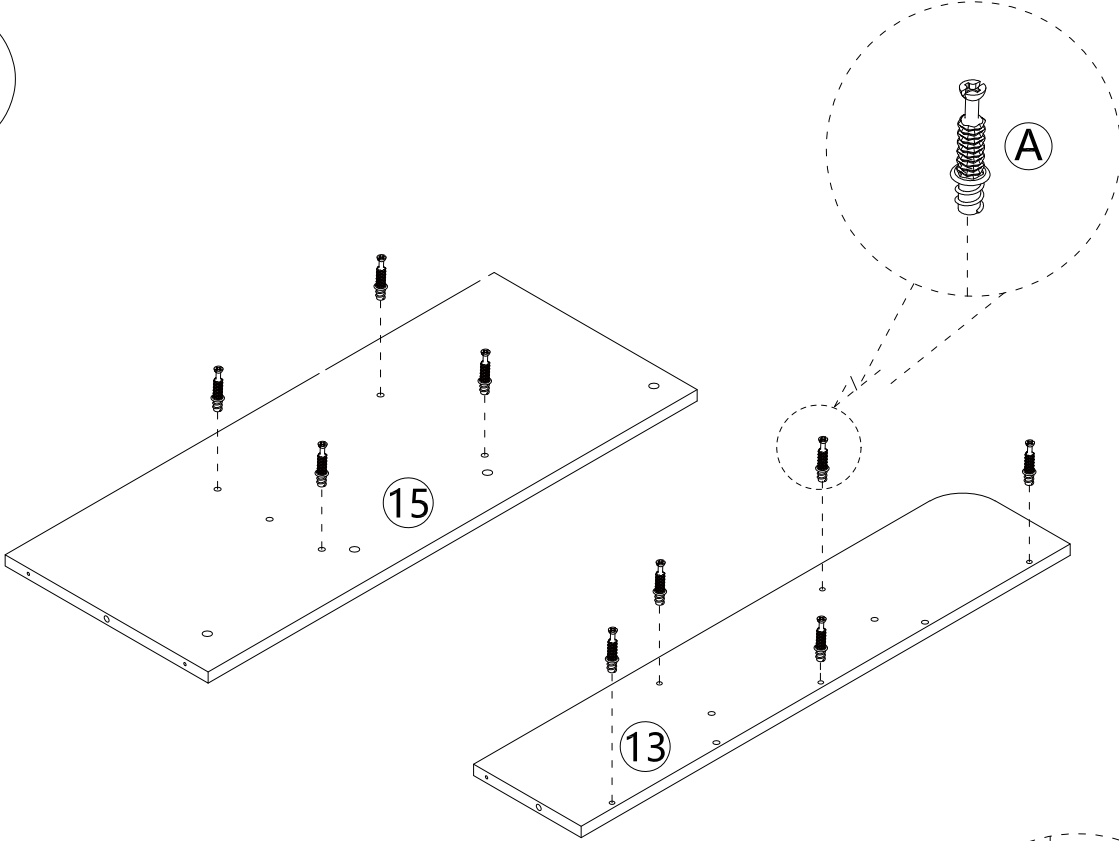

STEP 12

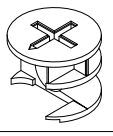
(B)	X5
	
$\phi 15 \times 9.5$	

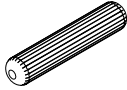
(C)	X4
	
$\phi 6 \times 30$	

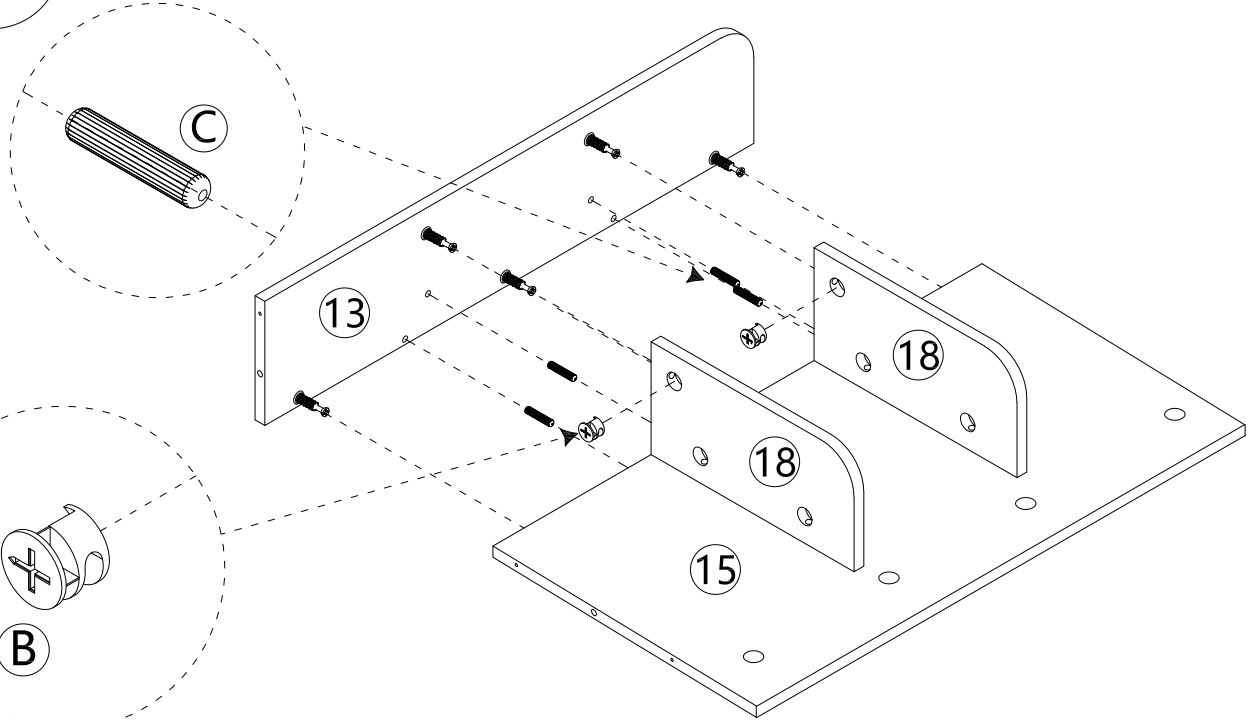
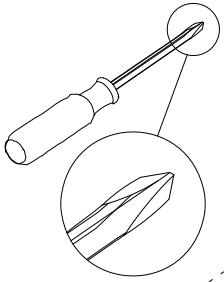

FLIP OVER

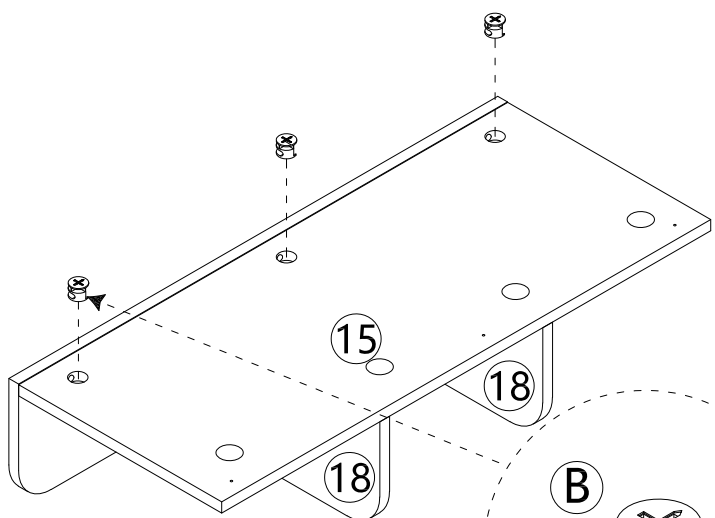

Insert the cam bolt into the hole first, then insert the cam lock and lock it.

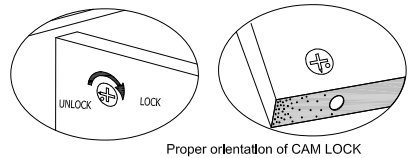

Proper orientation of CAM LOCK

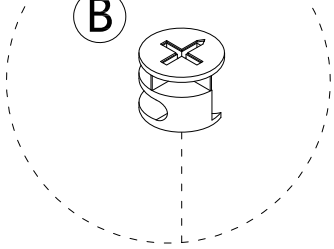

STEP 13

(A)	X9
	
Ø6x34	

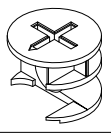
(B)	X4
	
φ15*9.5	

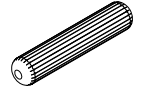
(C)	X2
	
φ6*30	

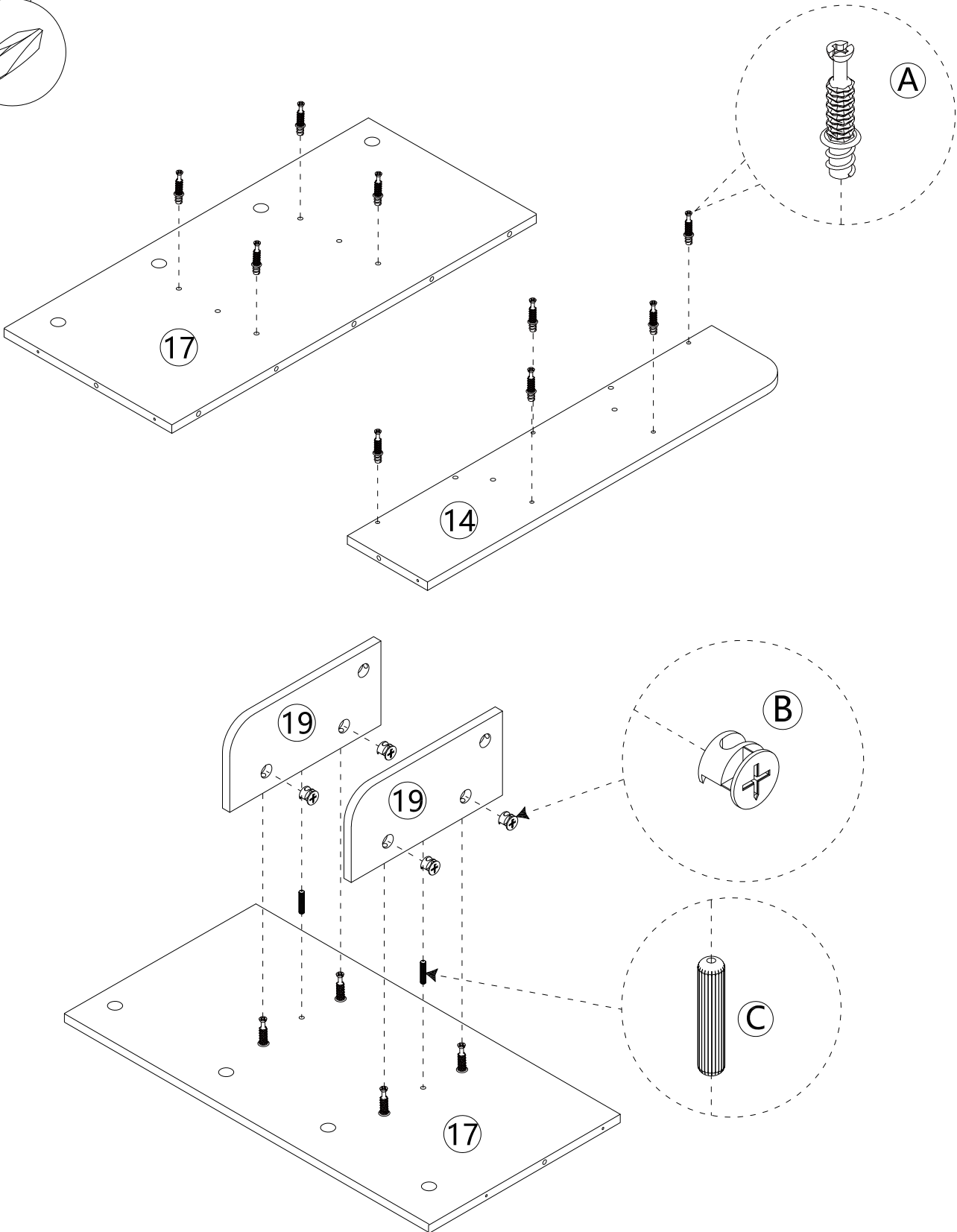
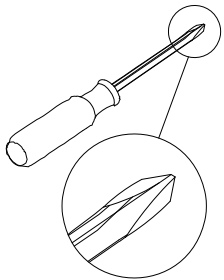

STEP 14

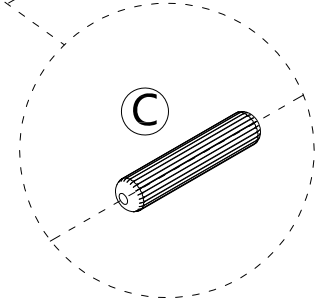
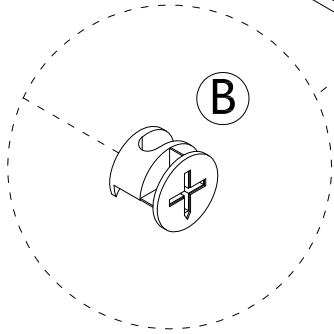
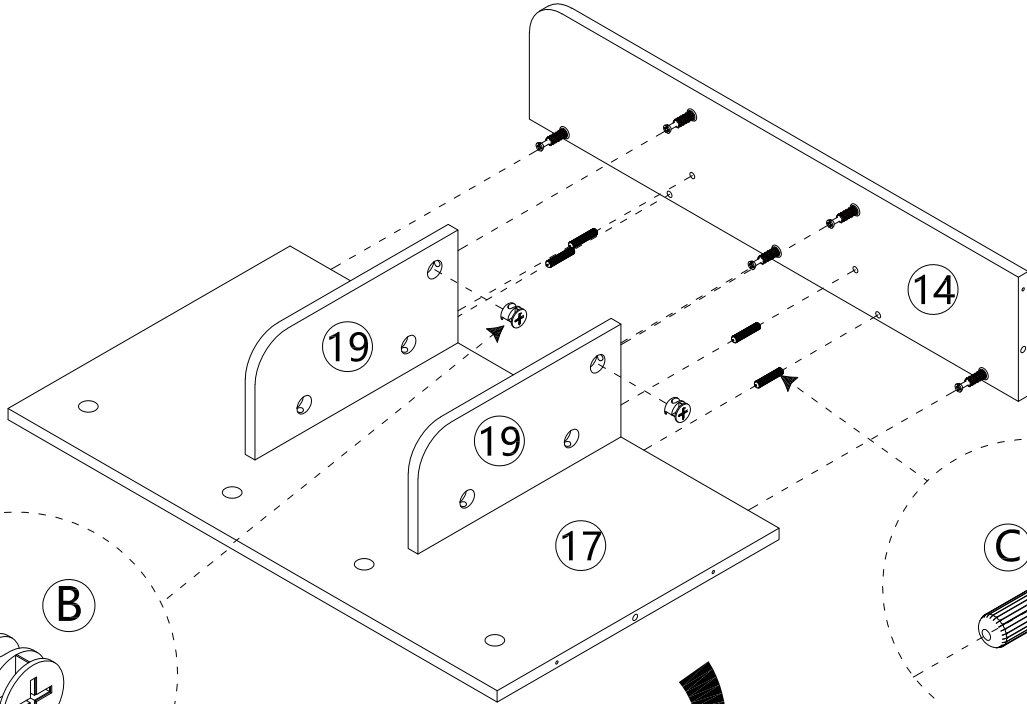
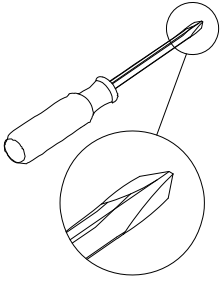
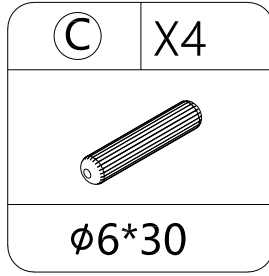
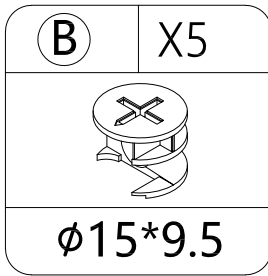

FLIP OVER

Insert the cam bolt into the hole first, then insert the cam lock and lock it.

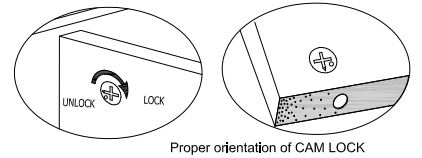

Proper orientation of CAM LOCK

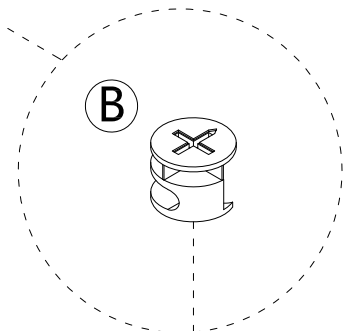
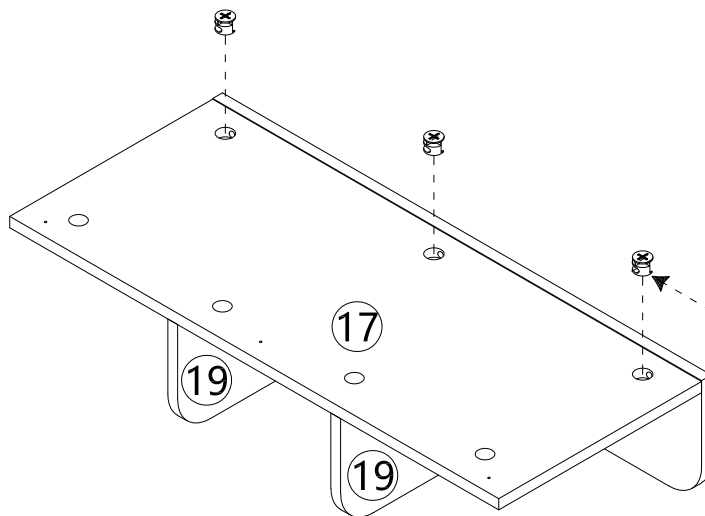

STEP 15

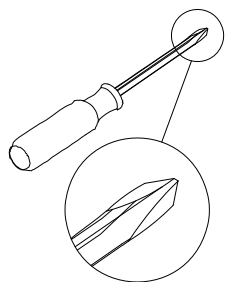

H	X6
45x15x1	

E	X12
Ø3.5x12	

THIS STEP REQUIRES 2 PEOPLE

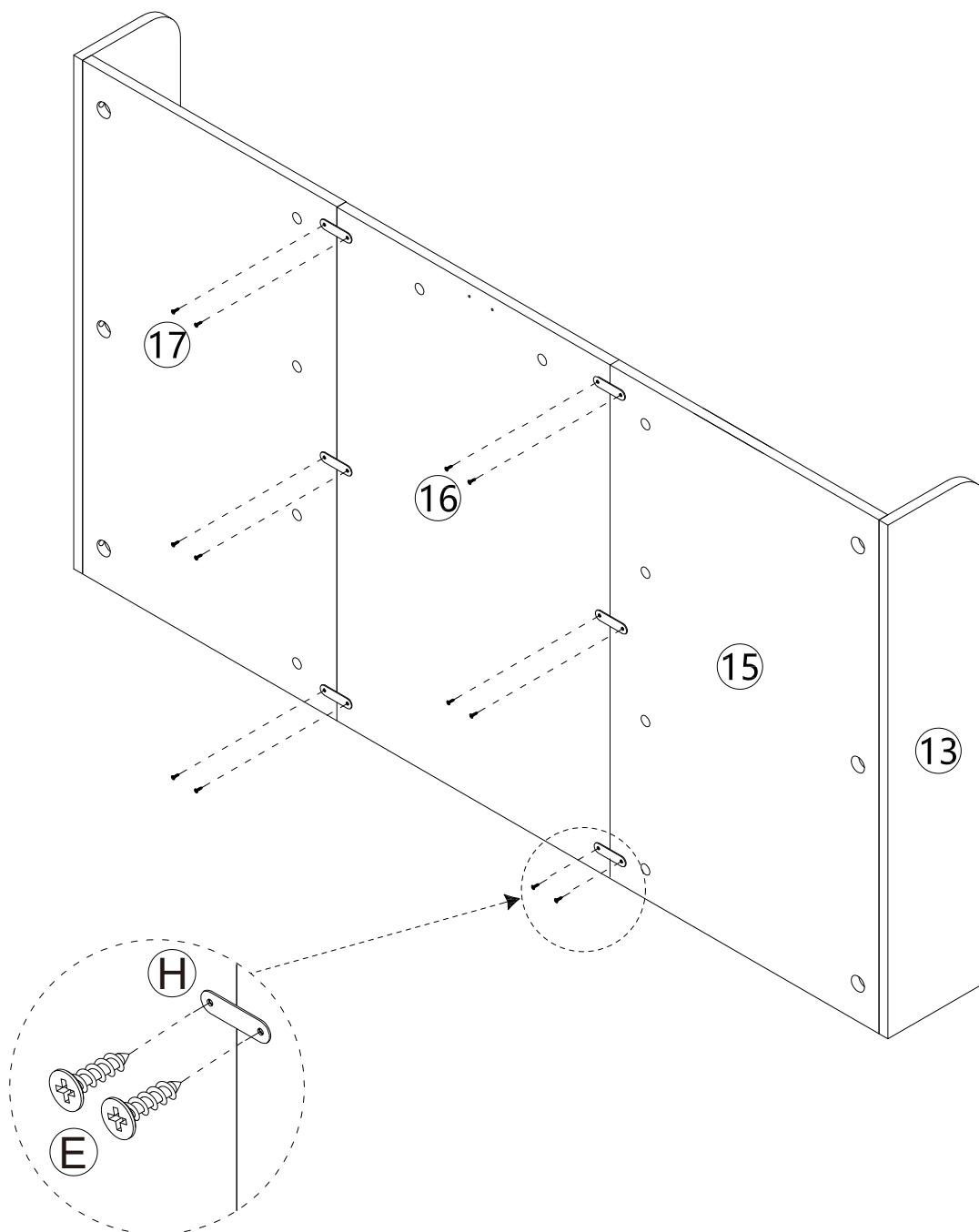

STEP 16

(A)	X8
	
Ø6x34	

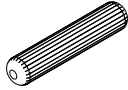
(C)	X6
	
φ6*30	

(F)	X11
	
φ4*35	

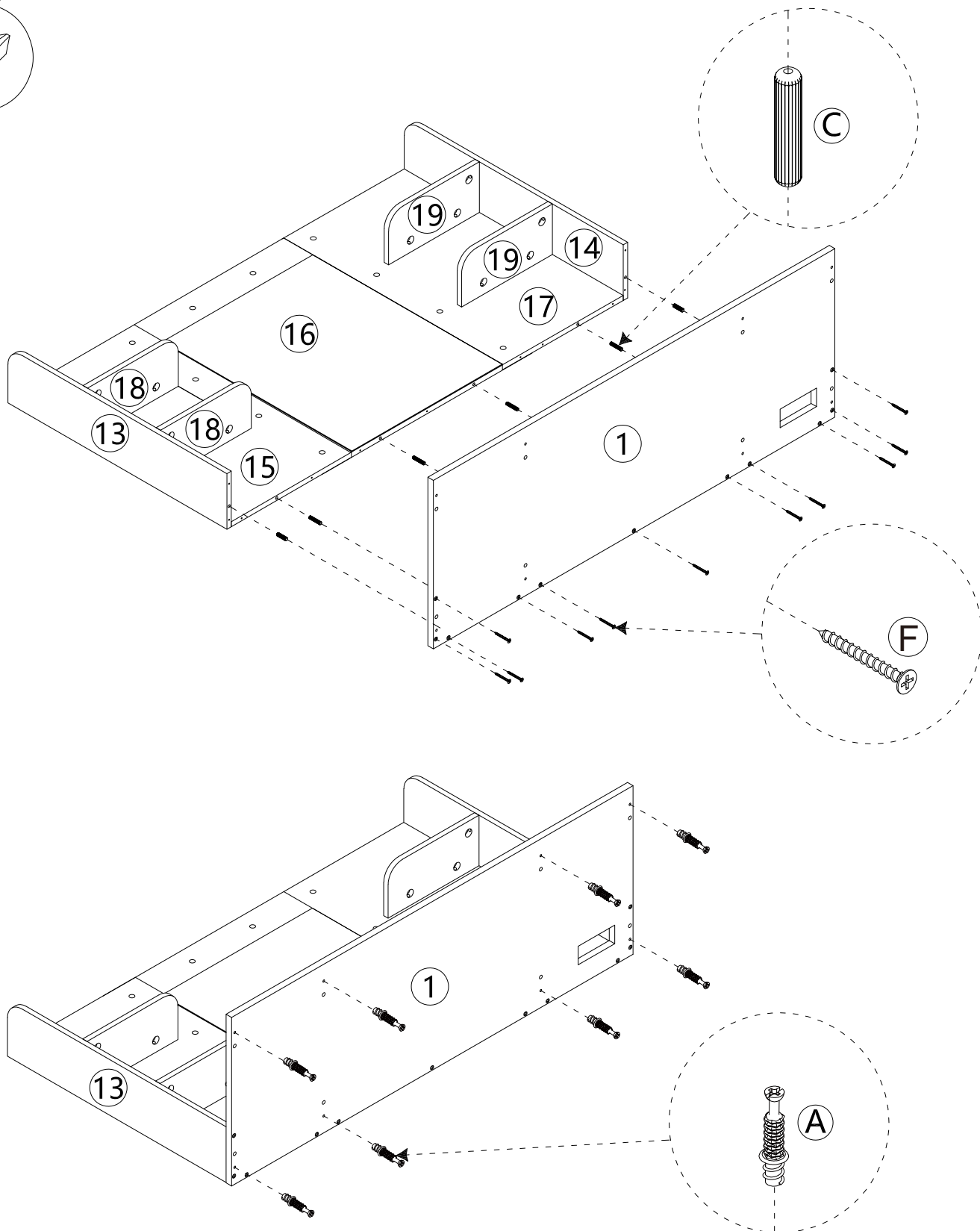
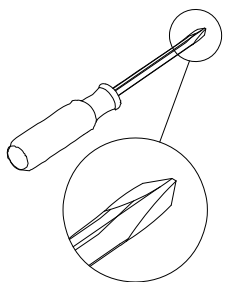

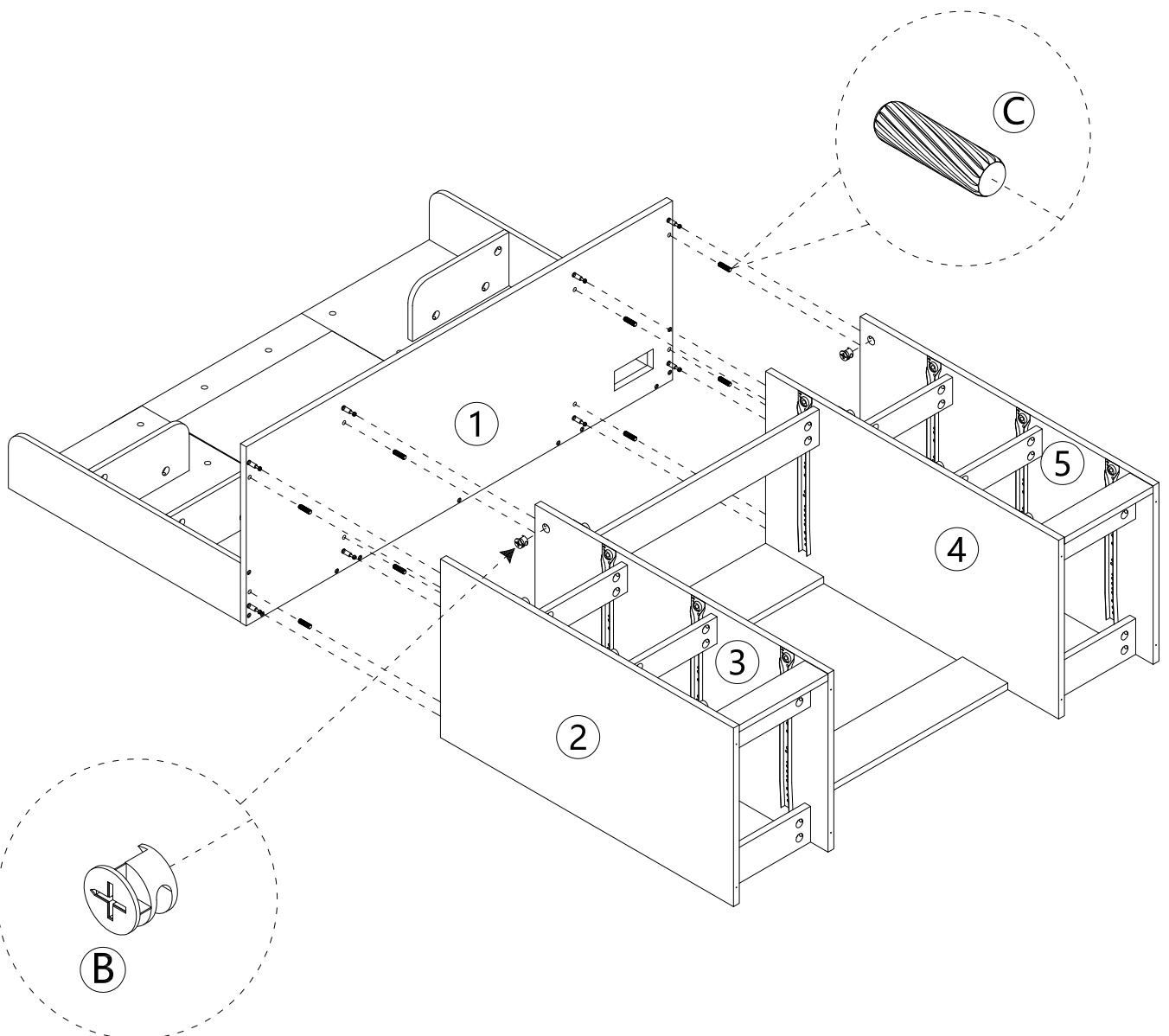
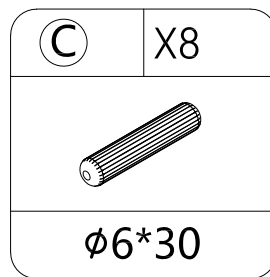
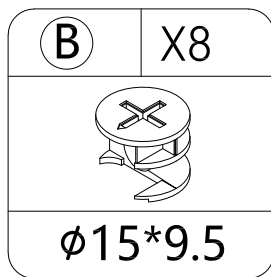
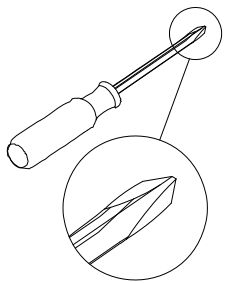

STEP 17



STEP 18

G	X26
	
Ø3.5x14	

K	X1
	
109*99*38.5	

M1	X1 set
	

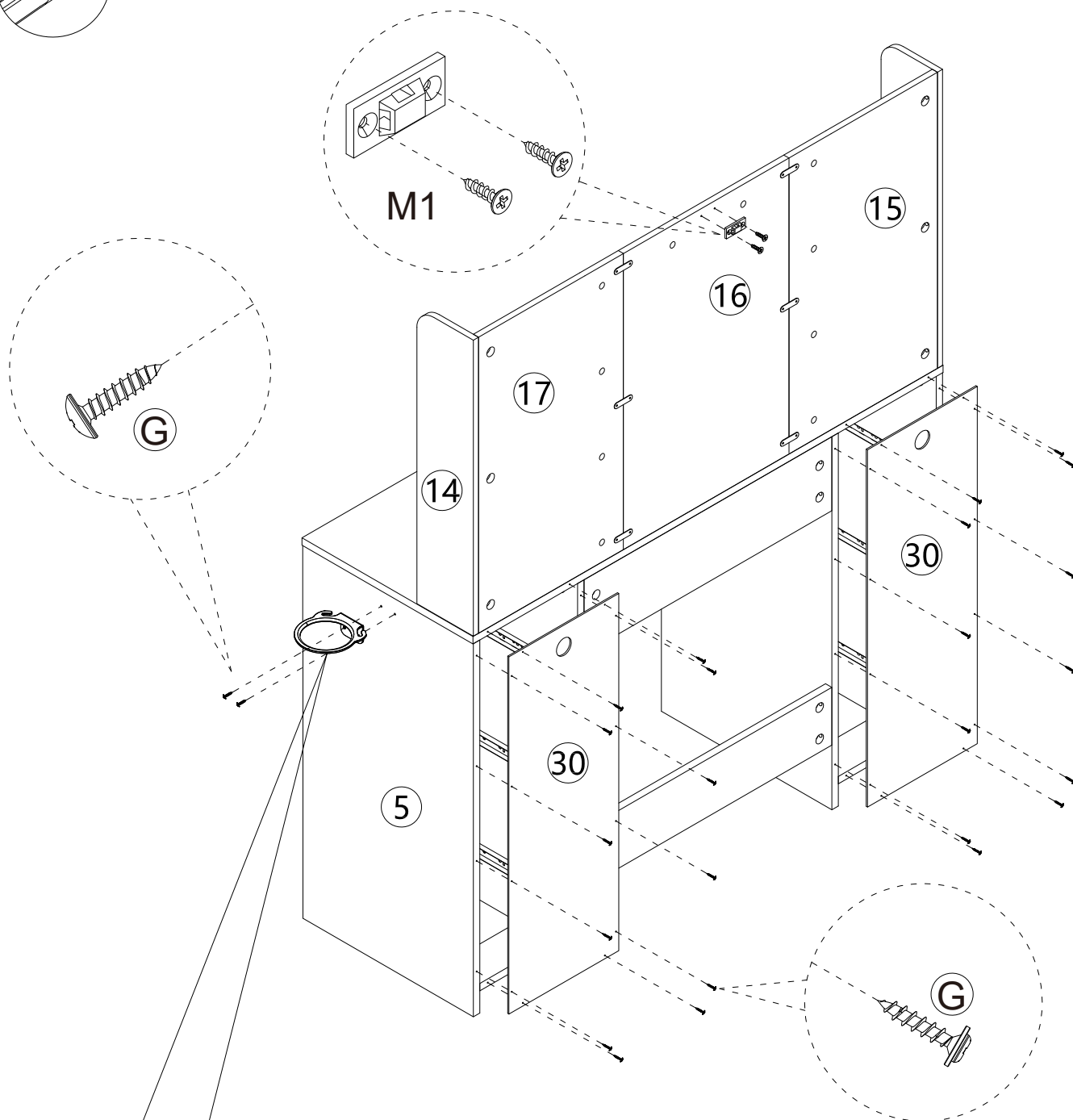
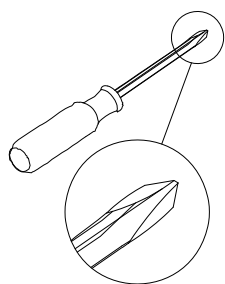

You can install the hair dryer rack(K) on the left or right according to your needs

STEP 19

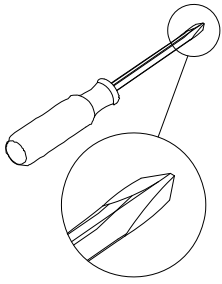

(F)	X24
$\phi 4 \times 35$	

(A)	X24
$\phi 6 \times 34$	

(B)	X24
$\phi 15 \times 9.5$	

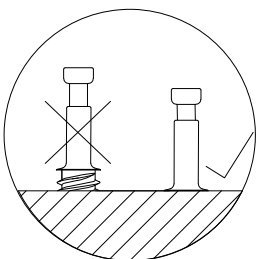
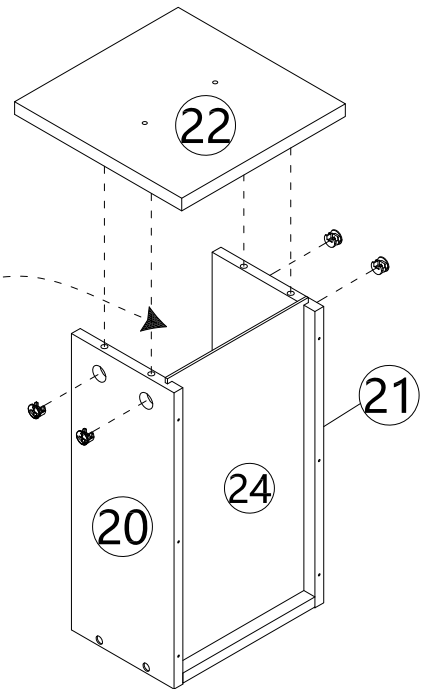
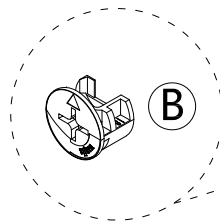
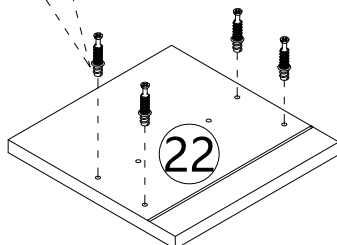
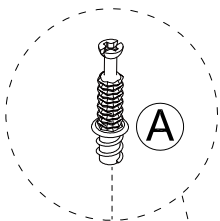
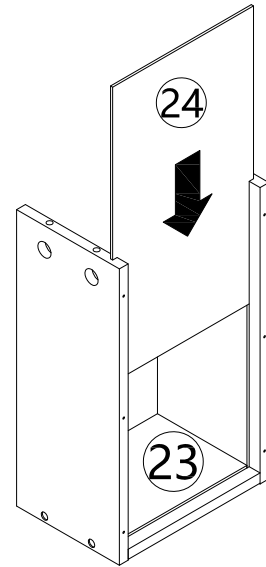
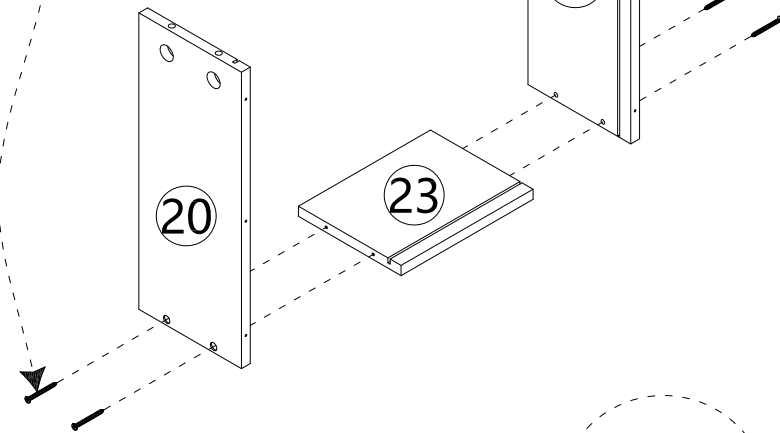
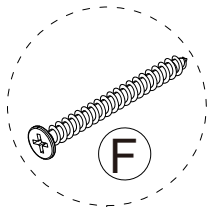

Insert the cam bolt into the hole first, then insert the cam lock and lock it.

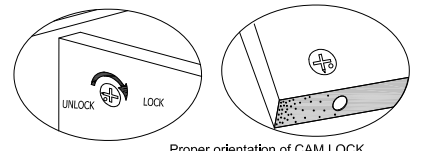

X 6

Proper orientation of CAM LOCK

STEP 20

(F)	X4
	
ø4*35	

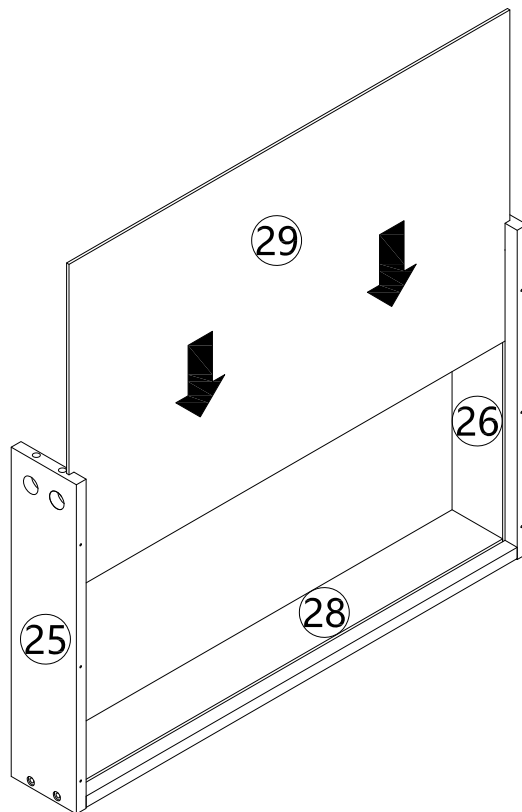
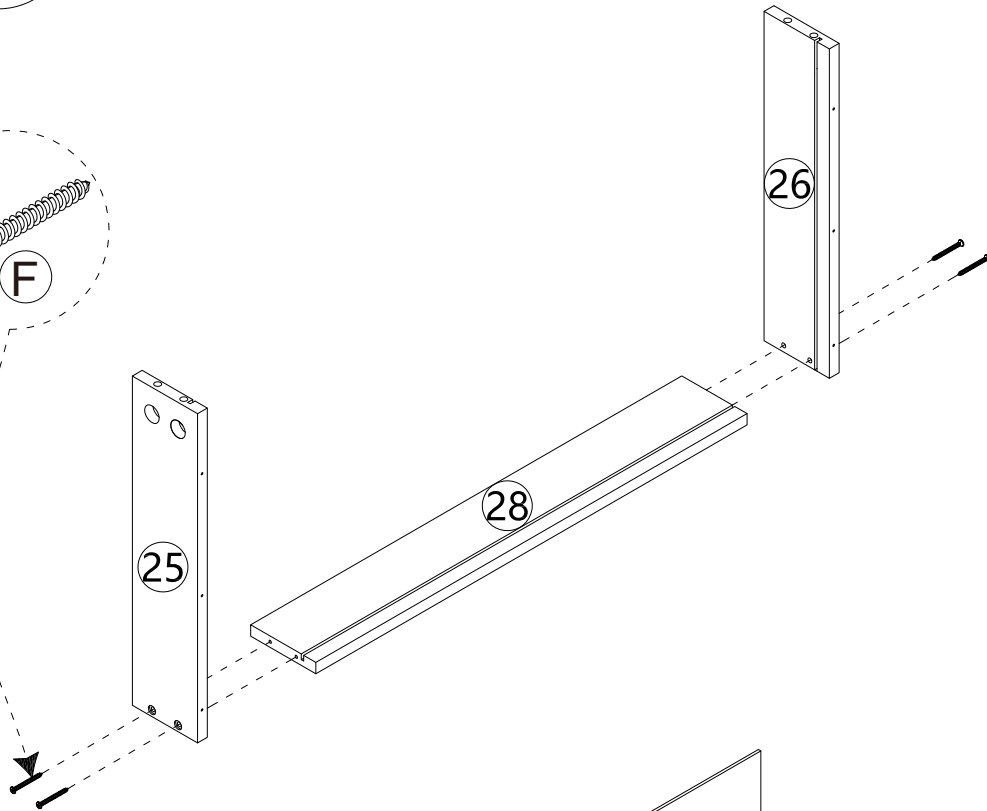
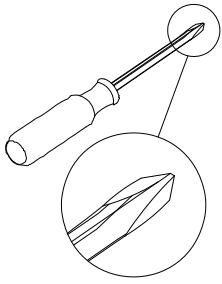

STEP 21

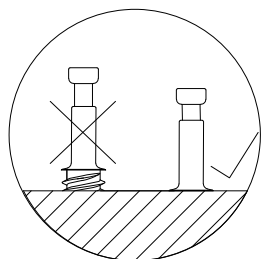
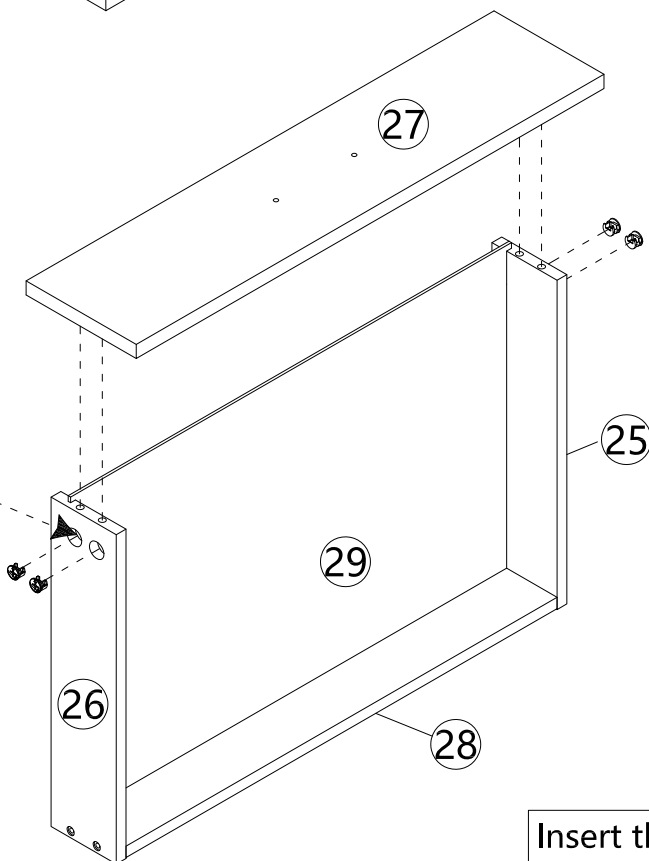
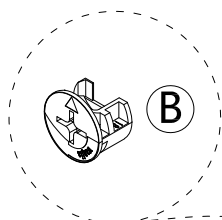
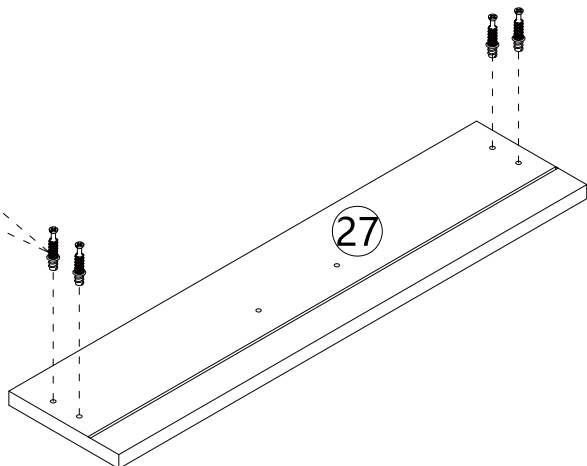
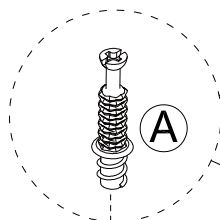
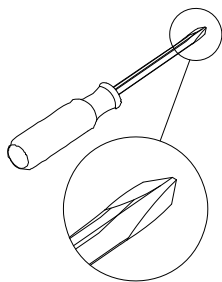
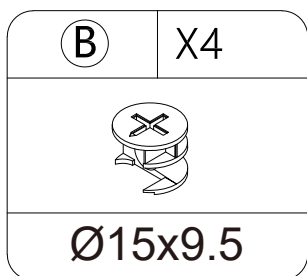
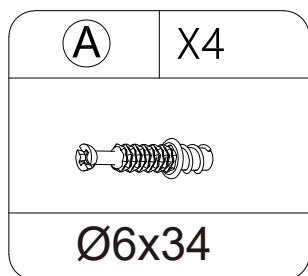

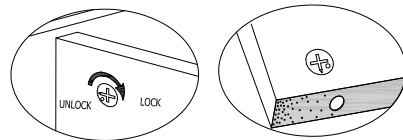

Insert the cam bolt into the hole first, then insert the cam lock and lock it.

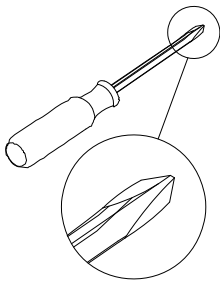

Proper orientation of CAM LOCK

STEP 22



(E)	X36
	
Ø3.5x12	

(L)	X6
	
DR L=350	

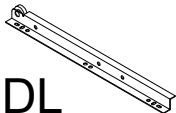
(L)	X6
	
DL L=350	

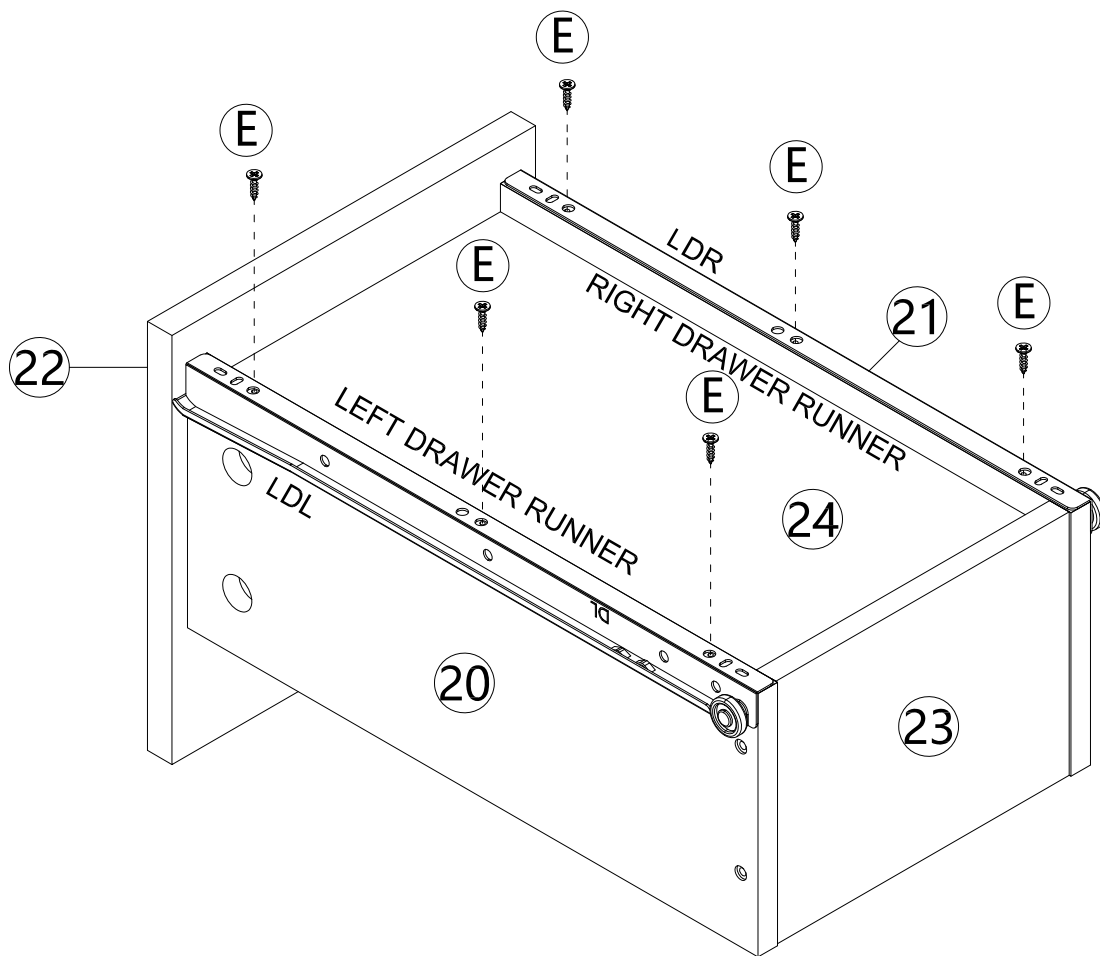

X 6

STEP 23

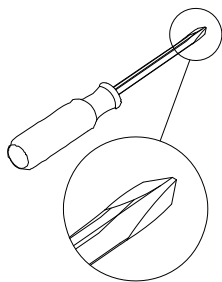

(E)	X6
	
Ø3.5x12	

(L)	X1
	
DR L=350	

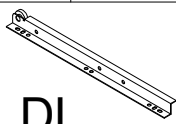
(L)	X1
	
DL L=350	

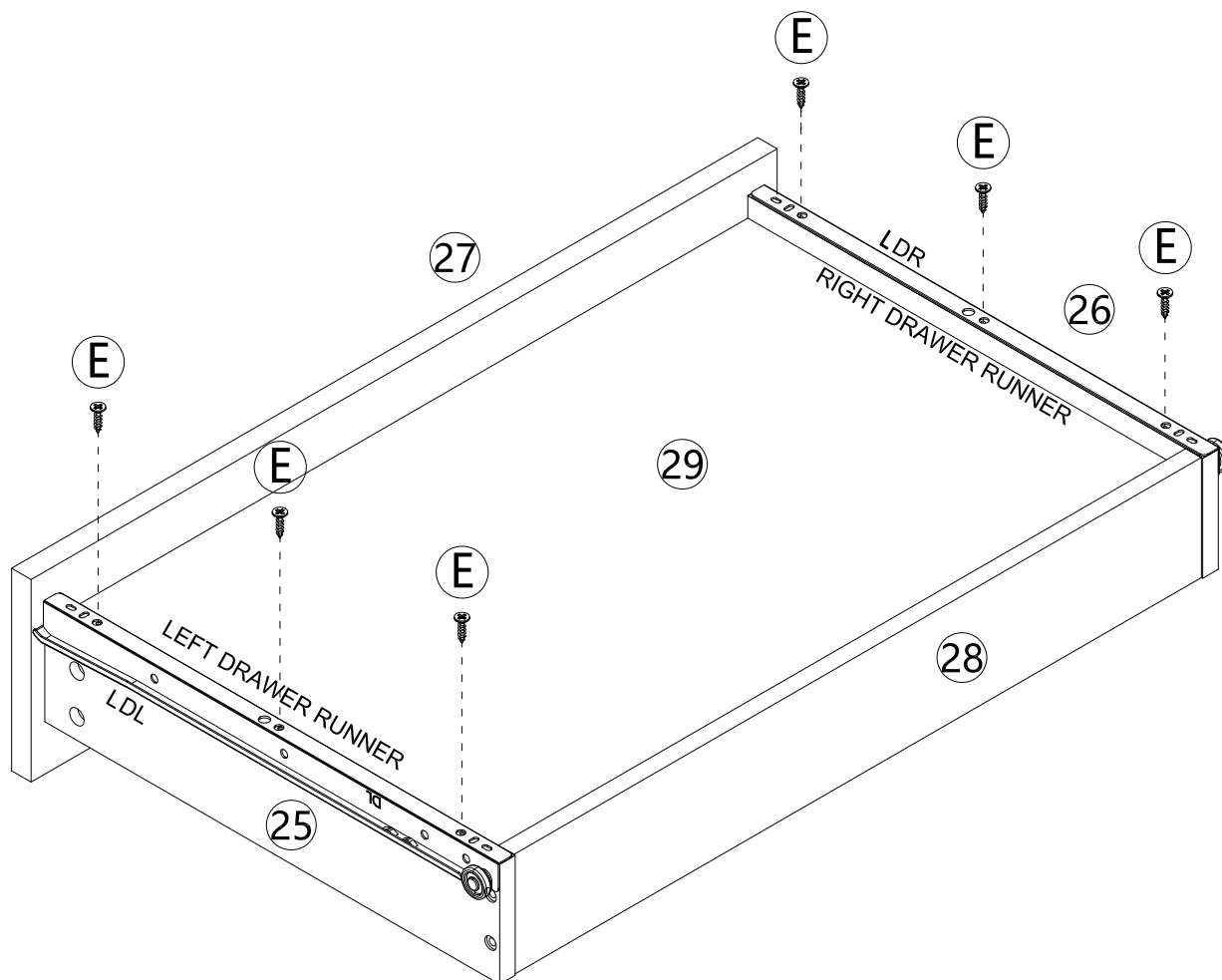

STEP 24

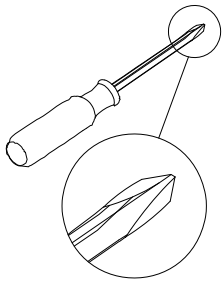
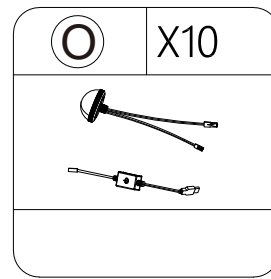
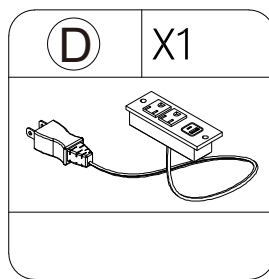
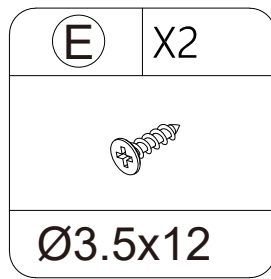

Tear off a layer of 3M polyethylene foam.

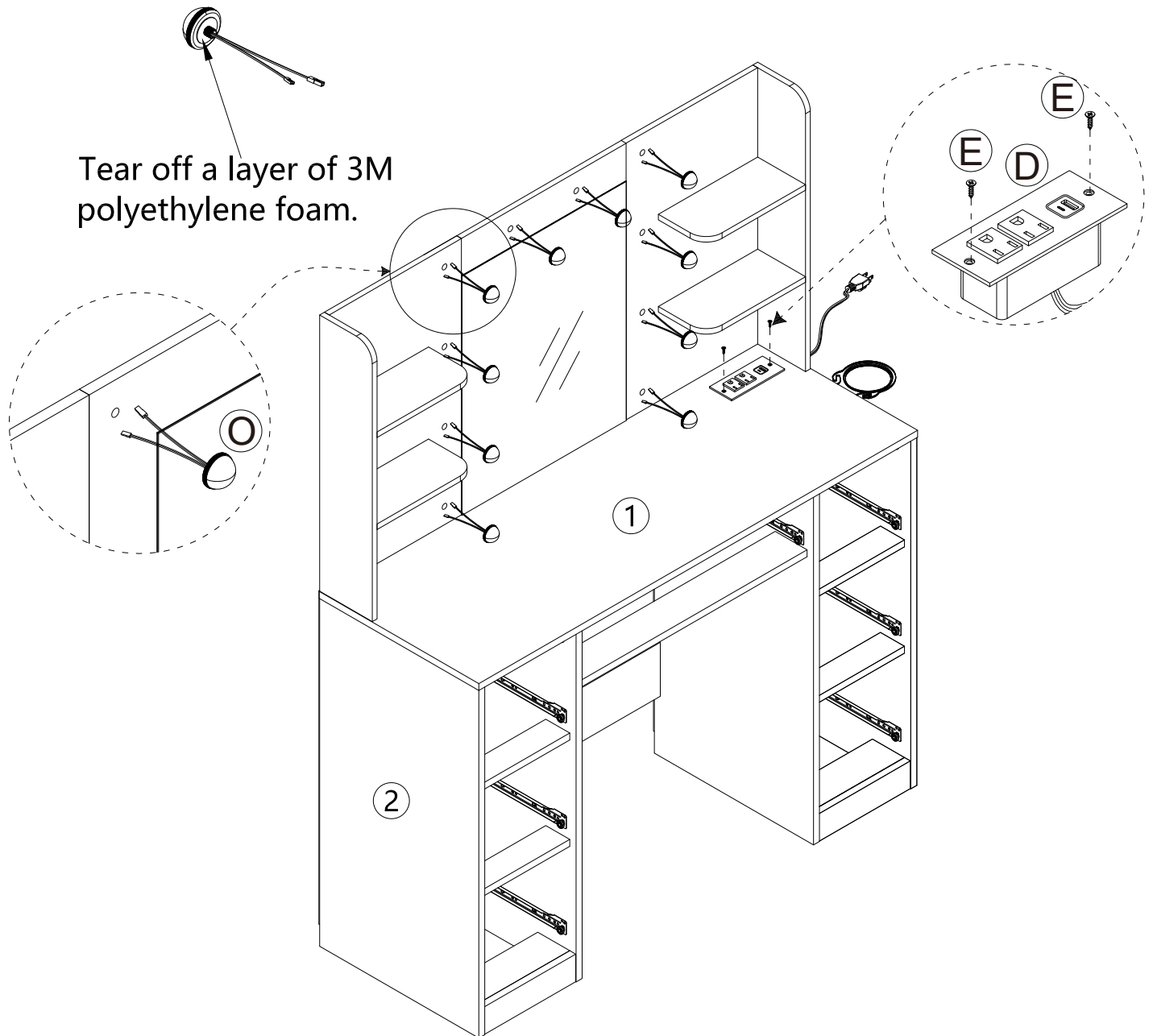

STEP 25

Pass the bulb wire through the pre punched plate, then gently press the bulb and make it adhere to the plate, and then connect the adjacent bulbs successively through the wire head slot on the opposite side (corresponding to the line of the same color).

When making up, you can use the switch to turn on or off the light. The dressing table brings you 3 color temperature light modes, touch the button you can easy light up the mirror and change colors to meet your different needs, long press to adjust the brightness.

When connecting the interface, please note that the colors of the wires at both ends correspond one by one.

same color correspond

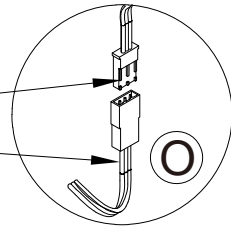
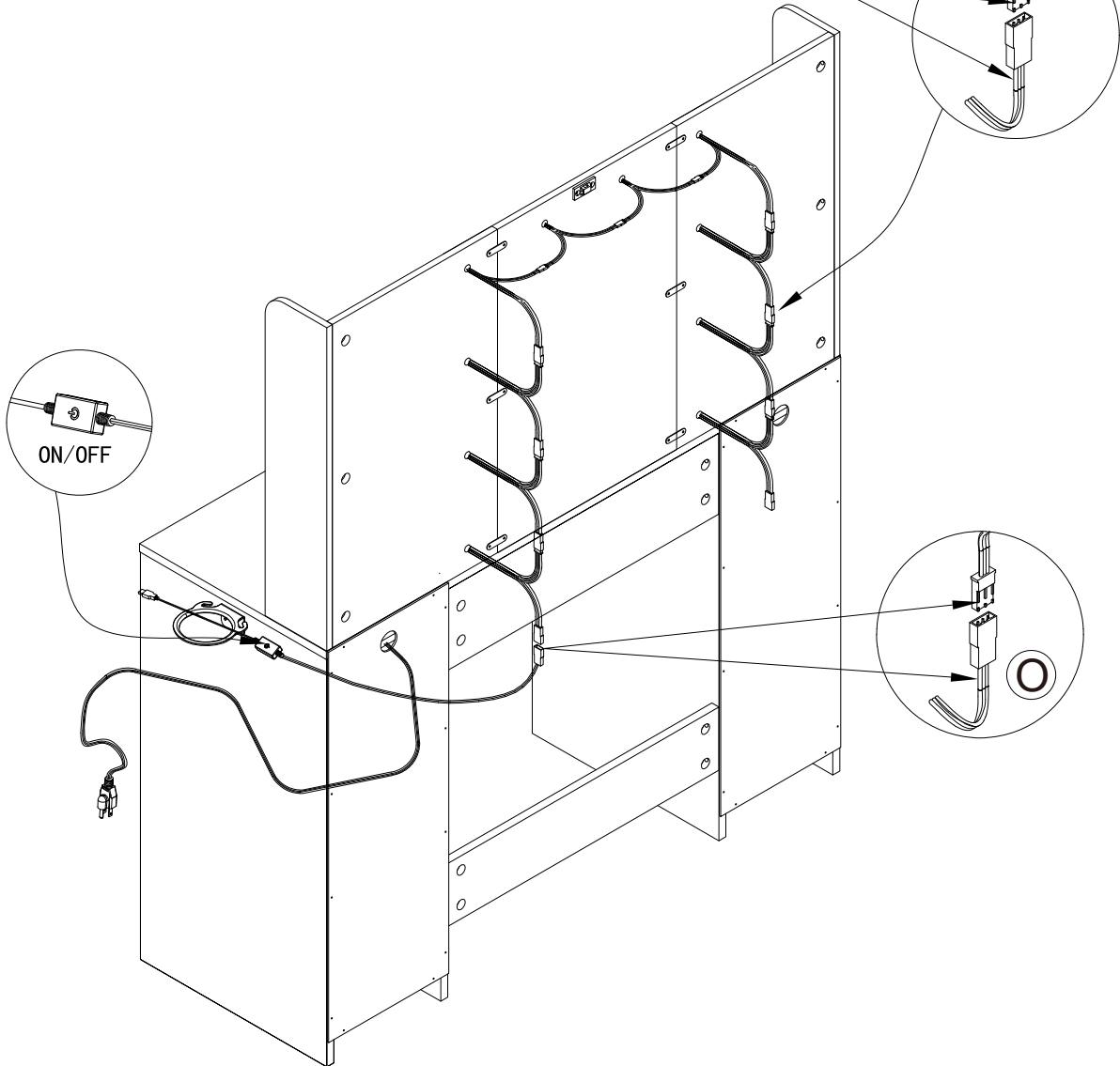
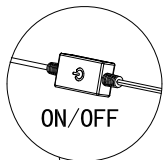

STEP 26

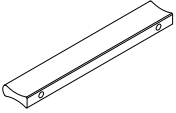
ⓐ	X7
	
106*16*8	

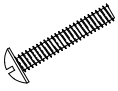
ⓙ	X14
	
5/32"x16	

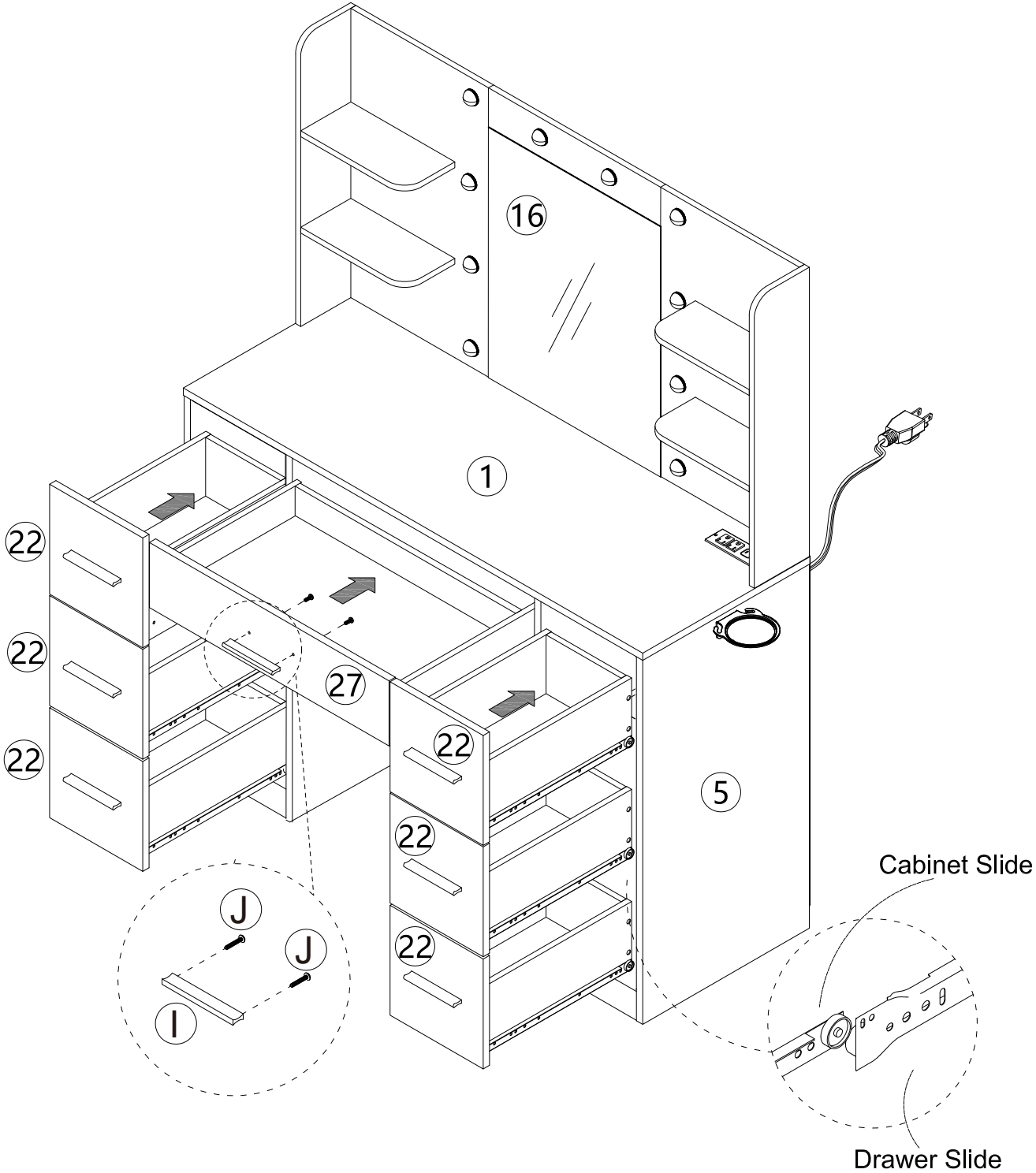
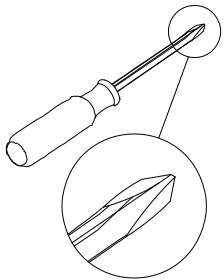

STEP 27

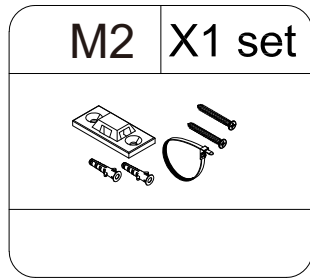

Install the tipping restraint hardware

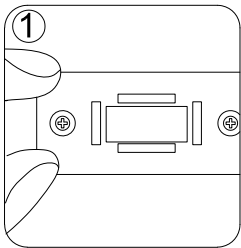

1. make mark on the wall

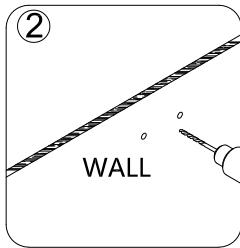

2. drill two $\varnothing 6$ holes on the wall

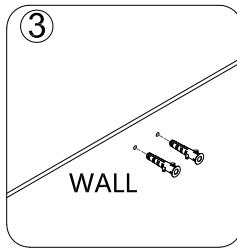

3. put two anchors in the holes

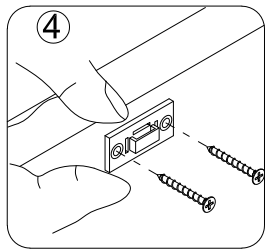

4. fix the device on the wall by the long screws

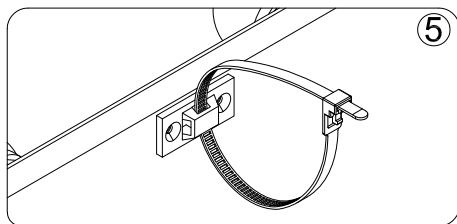

5. Push the cabinet close to the wall so that the two bases are close to each other, and then put on nylon tie to tighten it.

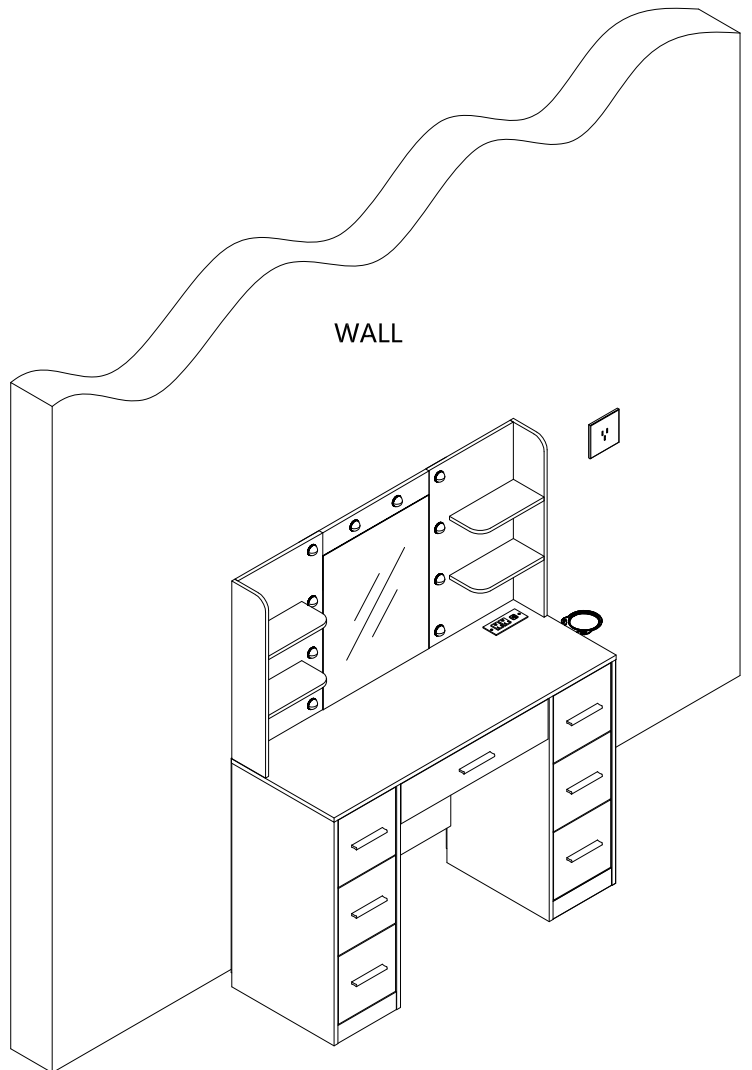

FURNITURE CARE AND MAINTENANCE

Thank you for your purchase. We want your item to last as long as possible. To ensure the product gives you years of service, please refer to this care and maintenance guide.



MAINTENANCE

Tighten all bolts and screws again within the first 2 weeks of assembly
Check the tightness of all bolts every 2 months, tighten them if necessary



CLEANING

Clean the surface of the MDF and PB (medium - density fiberboard) with a lightly dampened cloth.

Small amount of mild soap can be used if necessary

- Dry the surface immediately after cleaning.

⚠ DO NOT use bleach or alcohol detergent to clean the surface.

⚠ DO NOT apply wood treatment on parts made with MDF/PB.

Medium - density fiberboard and PB will swell and distort when suffer from water damage.
Make sure to dry the furniture immediately after cleaning