

ASSEMBLY INSTRUCTIONS

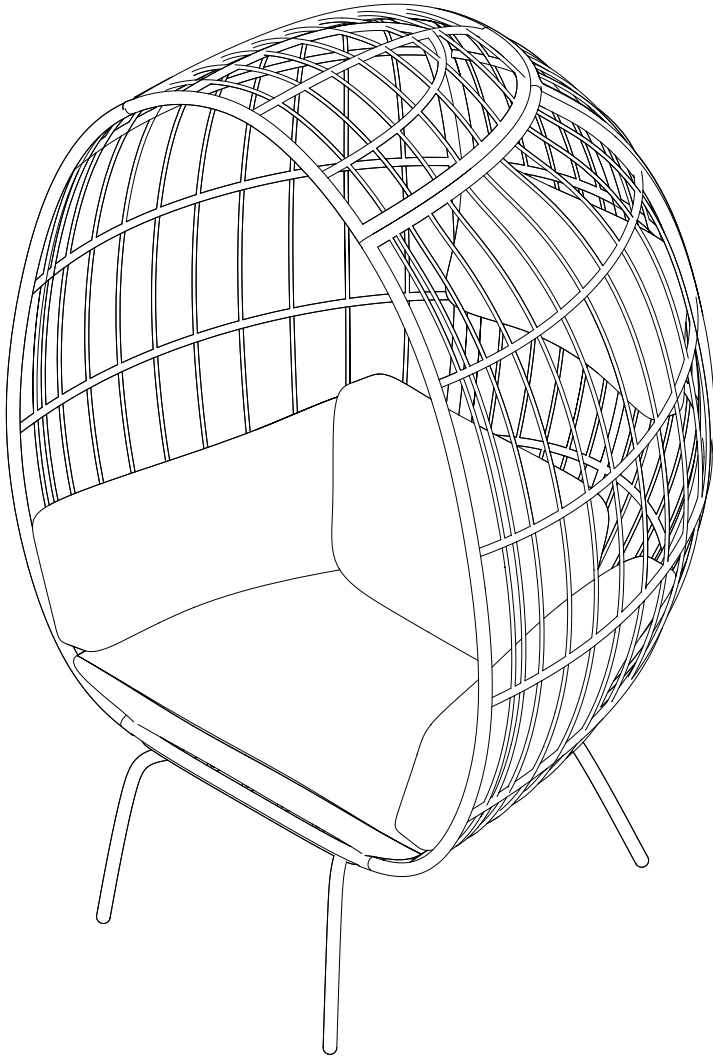



WICKER EGG CHAIR

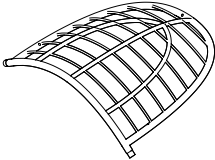
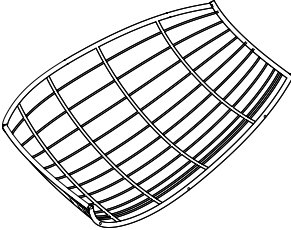
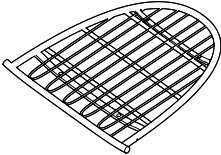
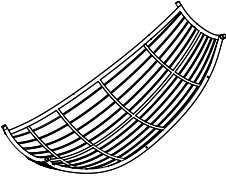
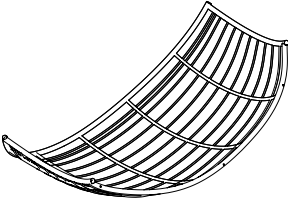

It is recommended that 2 people install the product.

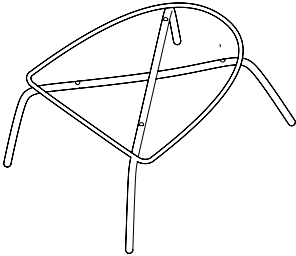
ASSEMBLY INSTRUCTIONS

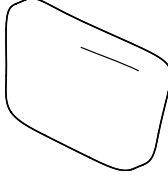
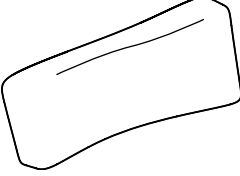
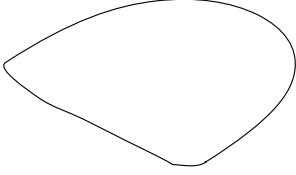
Item no.	Reference Image	Qty.
①		X1
②		X1
③		X1
④		X1
⑤		X1

Item no.	Reference Image	Qty.
⑥		X1
⑦		X1
⑧		X1
⑨		X2
⑩		X1

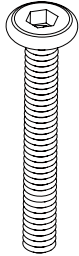
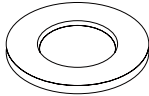
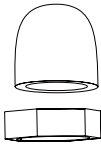
ASSEMBLY INSTRUCTIONS

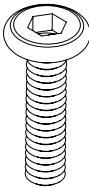
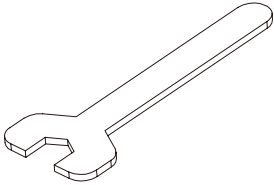
Item no.	Reference Image	Qty.	Item no.	Reference Image	Qty.
Ⓐ	 M6*55	X13	Ⓓ	 M6*16*1.0	X30
Ⓑ		X13			X1
Ⓒ	 M6*35	X4			X1

ASSEMBLY INSTRUCTIONS

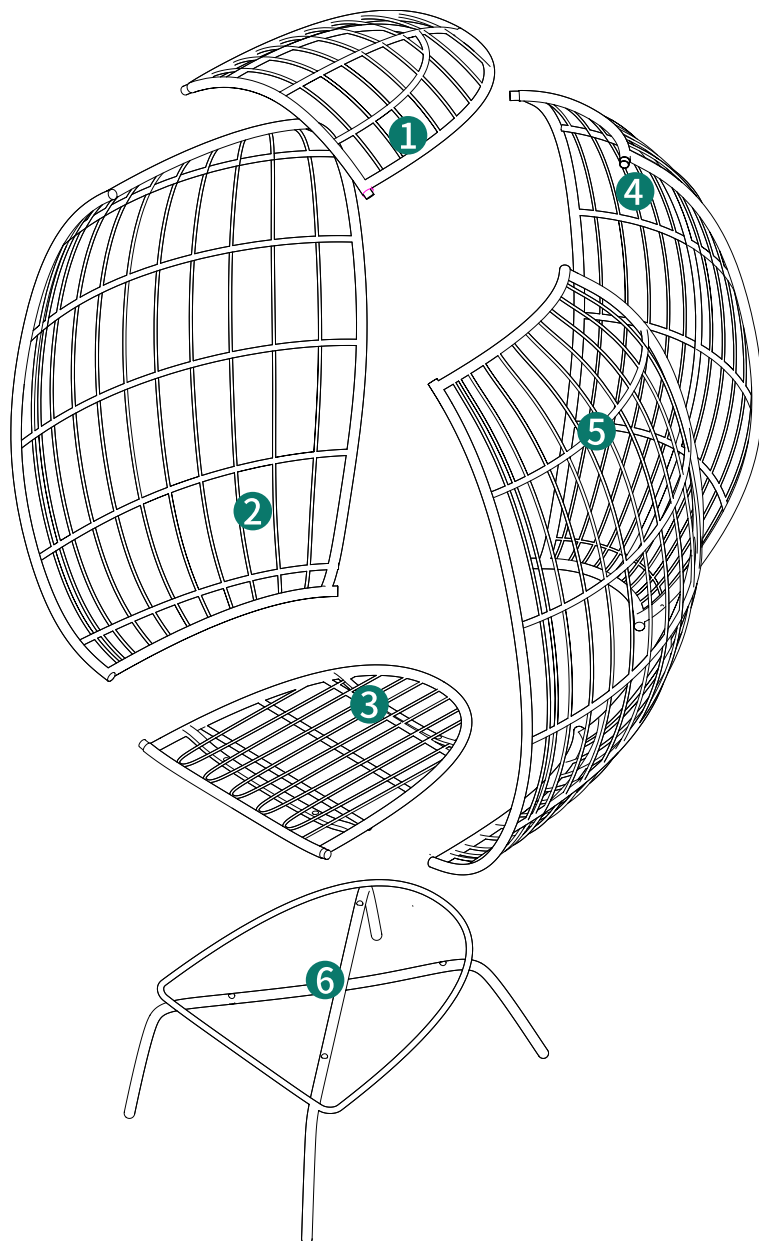

ASSEMBLY INSTRUCTIONS

1

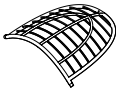

①1pc

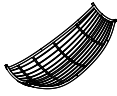

④1pc



⑤1pc



Ⓐ5pcs



Ⓑ5pcs

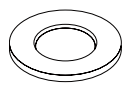

Ⓓ10pcs

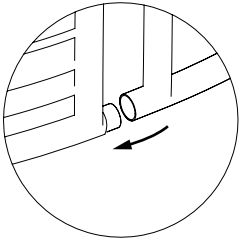

The tube needs to be embedded-installed.

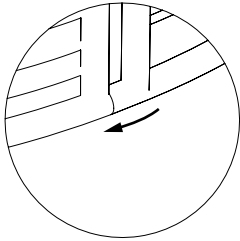
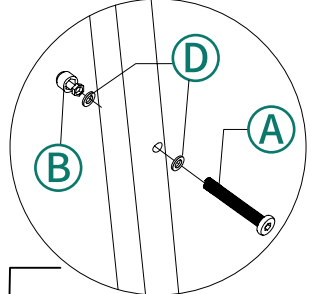

When the tube embeds completely.

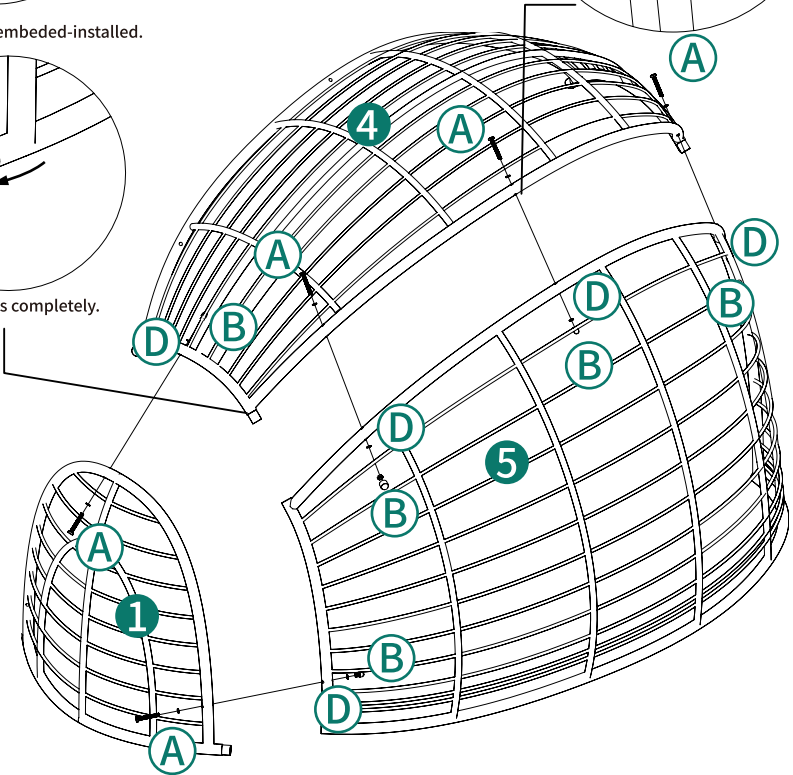

ASSEMBLY INSTRUCTIONS

2

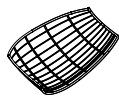

② 1pc



Ⓐ 4pcs



Ⓑ 4pcs



Ⓓ 8pcs

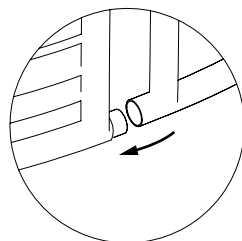
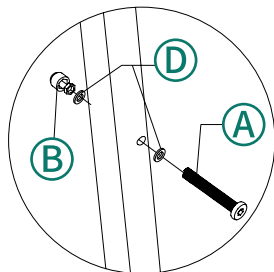

The tube needs to be embedded-installed.

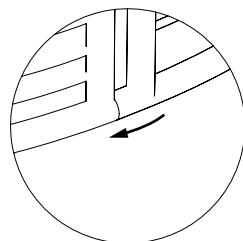

When the tube embeds completely.

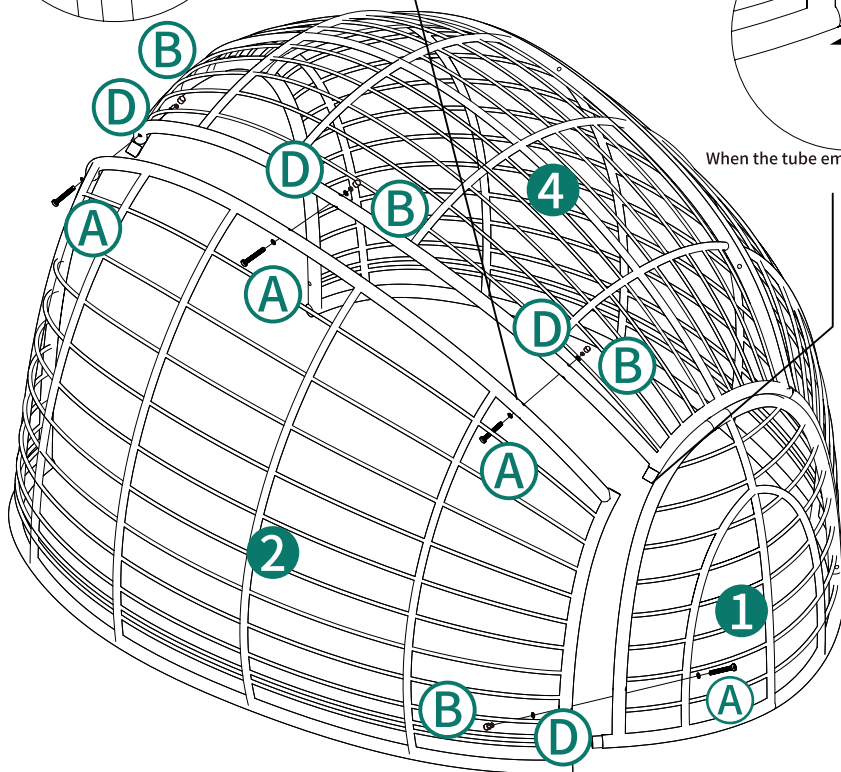

ASSEMBLY INSTRUCTIONS

3

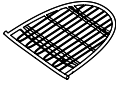

③ 1pc



Ⓐ 4pcs



Ⓑ 4pcs

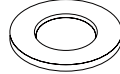

Ⓓ 8pcs

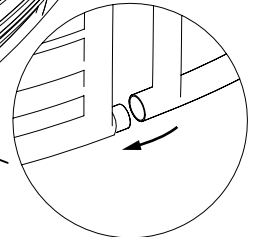
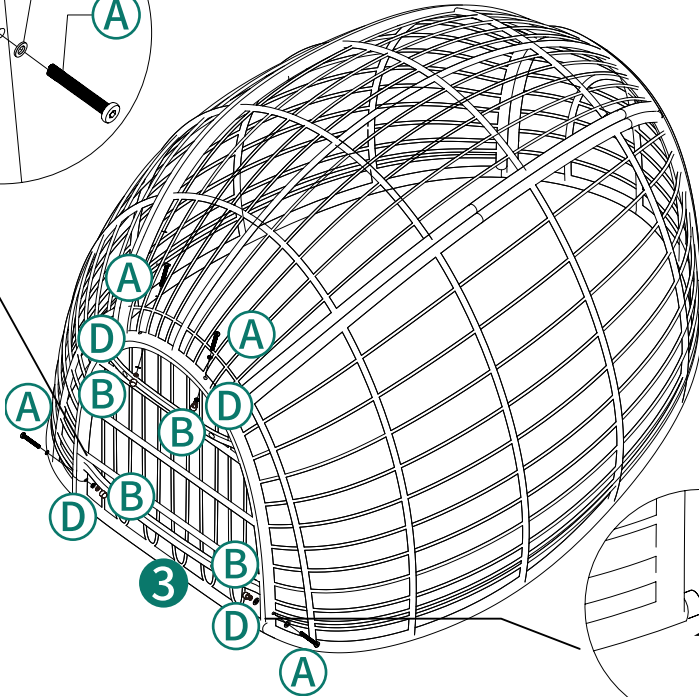
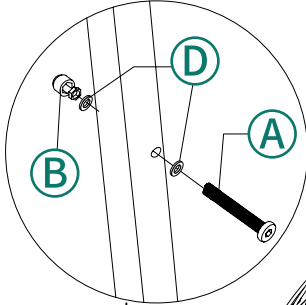

The tube needs to be embeded-installed.

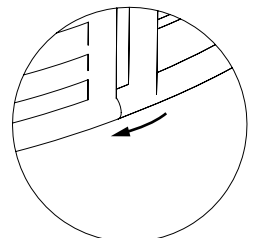

When the tube embeds completely.

ASSEMBLY INSTRUCTIONS

4



⑥1pc

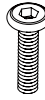

③4pcs

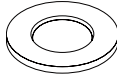

④4pcs

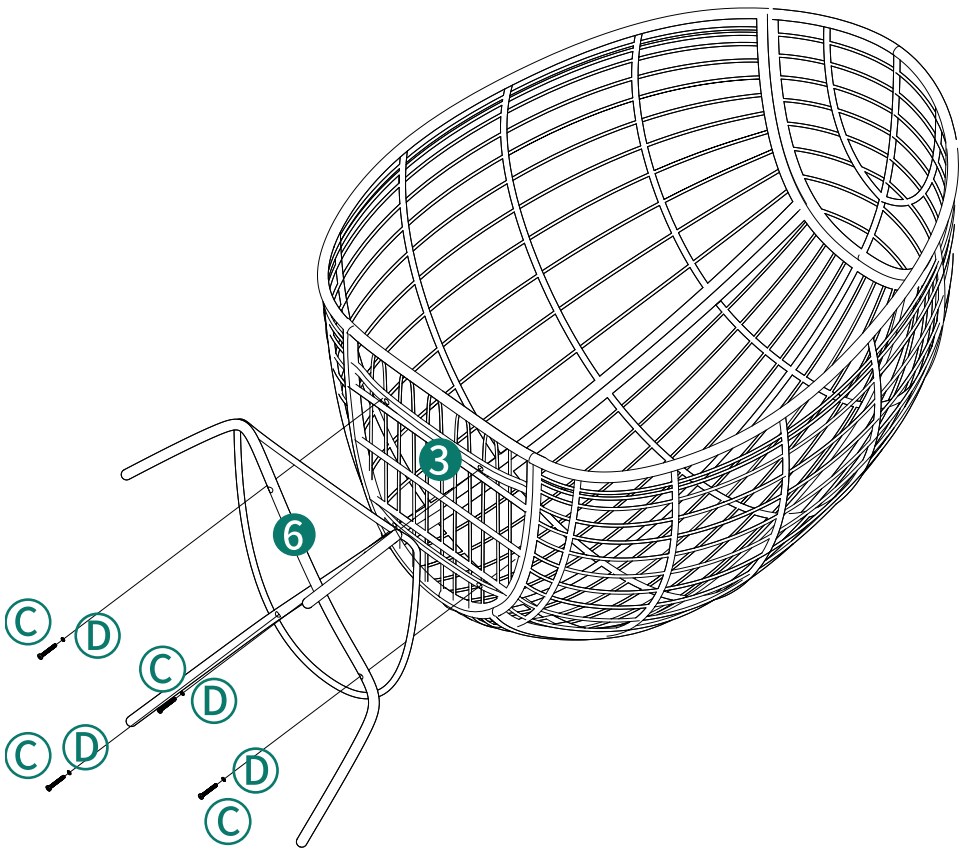

ASSEMBLY INSTRUCTIONS

5



⑦ 1pc



⑧ 1pc



⑨ 2pcs

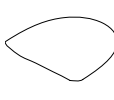

⑩ 1pc

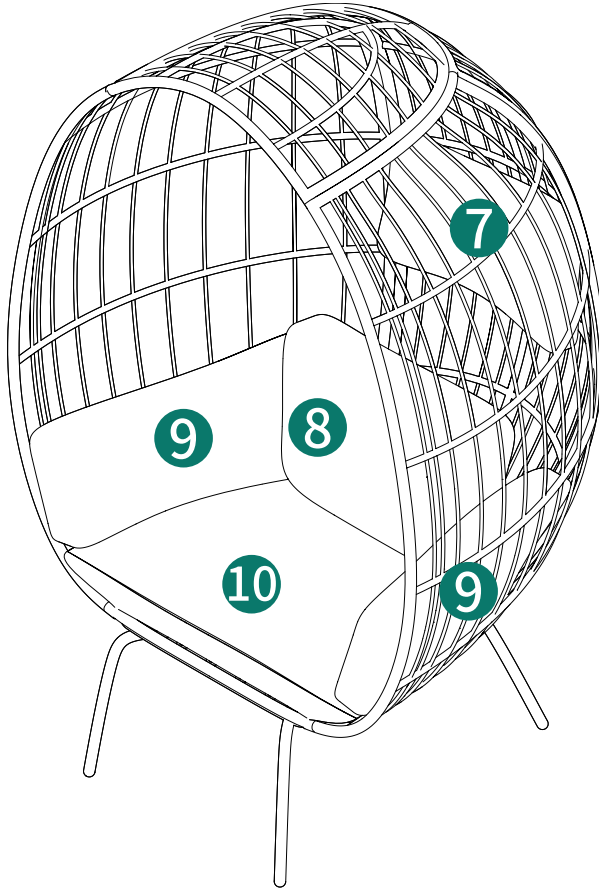

Put the cushion on the seat

INSTALLATION
COMPLETED