

Oval Coffee Table

Assembly Guide

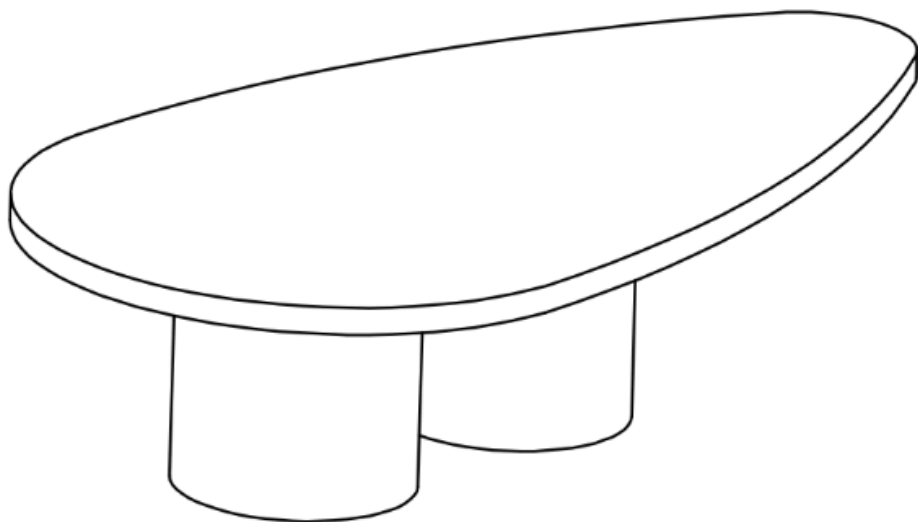

IMPORTANT: please read these instructions fully before starting assembly



**SAFETY AND
CARE ADVICE**



NO POWER TOOLS

- Check you have all the components and tools listed
- Remove all fittings from their bags and separate into groups
- We do not recommend use of power tools - this could damage the unit. Only use hand screwdrivers and Allen keys
- Keep children and animals away from the work area, small parts could cause choking if swallowed
- Make sure you have enough space to lay out the parts before starting
- Assemble the item as close to its final position (same room) as possible
- Do not over tighten the nuts to avoid damage to the threads
- Only clean using a damp cloth and mild detergent. Do not use bleach or abrasive cleaners
- From time to time, check there are no loose screws in this unit
- This product should not be discarded with household waste. Take to your local authority waste disposal centre

IMPORTANT INFORMATION



20 Minute
Build



Two Person
Build





Max Weight
Capacity
30kg





Note: Assembly estimates are approximate and can differ based on the specific environment and user experience.

WHAT'S IN THE BOX

Note: the quantities are the correct amount to complete the assembly. In some cases more fixings may be supplied than are required.

A-Rods are packed in legs carton, at the side between foam and carton wall and connected with a red ribbon.

Label	Part Name	Drawing	Quantity
1	Top		1
2	Leg		2

Label	Hardware Description	Drawing	Size (mm)	Quantity
A	Rods		M8x350mm	8
B	Washers		M8x22mm	8
C	Nuts		M8x16mm	8
D	Allen key		M8x50mm	1
E	Table Foot		M6x20mm	8

- Work on a flat, clean surface to prevent scratches or uneven assembly.
- Insert and align all fixings first, then tighten them evenly.
- Do not over-tighten, as this may damage parts.
- Lift and position the tabletop with two people to avoid damage.
- Attach rods to the tabletop using the stopper end only to prevent damage.

STEP 1

Screw the rods **[A]** into top **[1]** .

Hardware	Pieces
	8

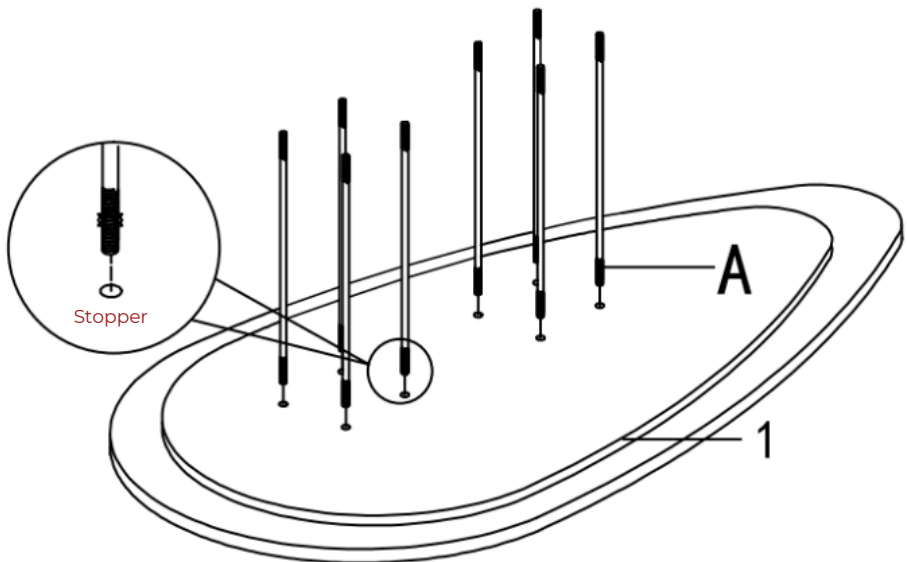

STEP 2

Gently put the legs **[2]** into the rods and fix with accessories **[B]** **[C]** **[D]** .

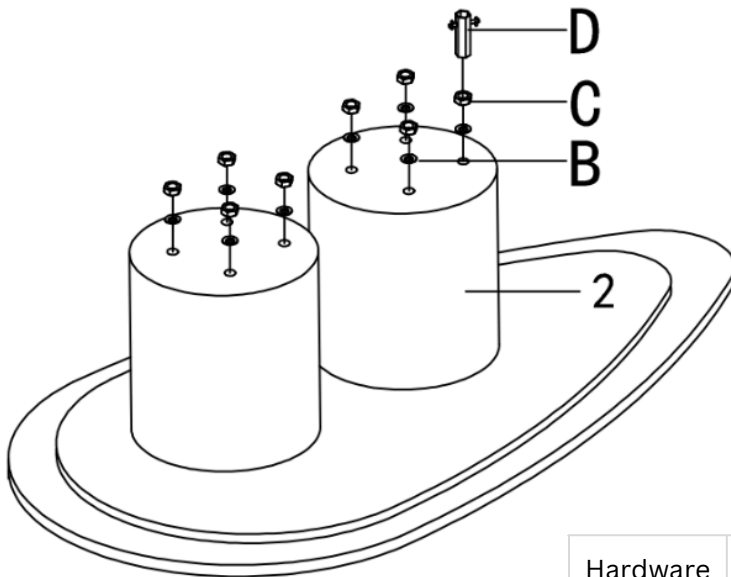



Hardware	Pieces
	8
	8
	1

STEP 3

Screw the adjustable table foot
【G】 into legs.

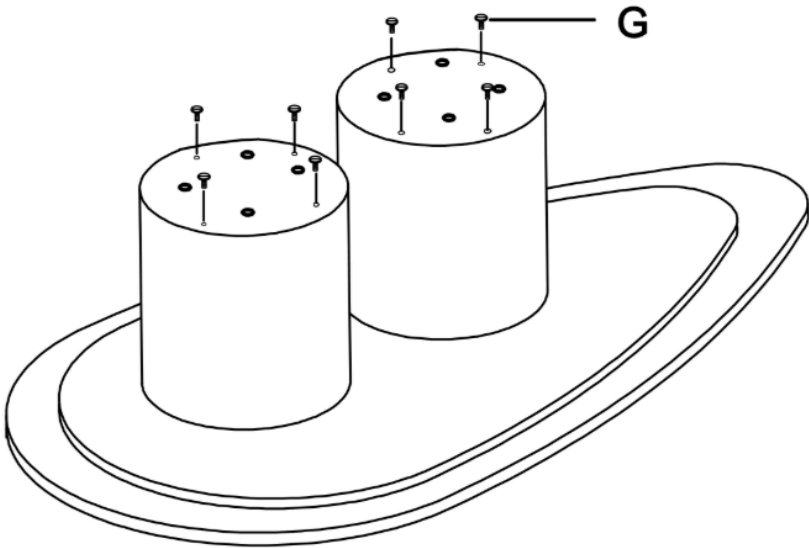
If necessary, the table can be
stabilized by adjusting the feet.



Hardware	Pieces
	8

STEP 4

Your table is now fully assembled.

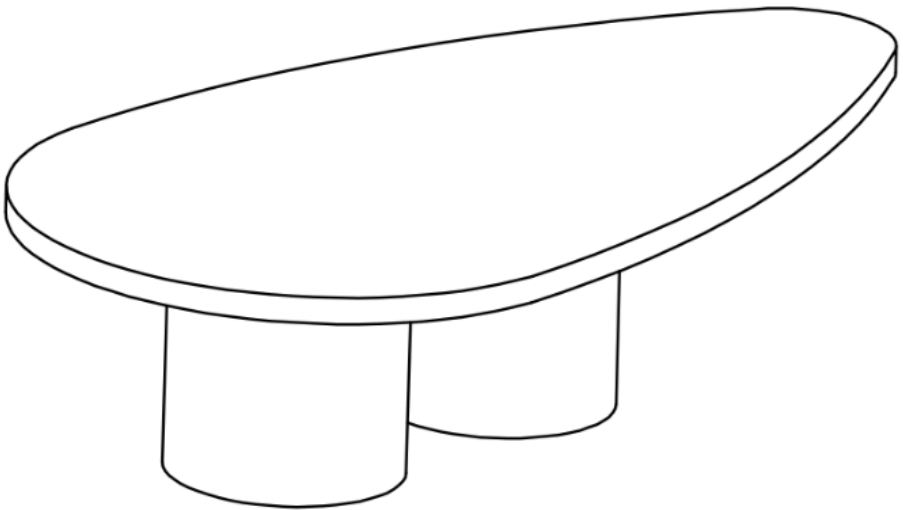



our 2 year GUARANTEE

Our products come with a 2 year guarantee, giving you extra peace of mind when shopping with us

What the guarantee covers



PRE-INSERTED FIXINGS



FAULTY JOINTS



EXTERNAL FIXING FAULTS



STRUCTURAL INTEGRITY
