

① arms

D0177-5:5pcs
D0177-6:6pcs

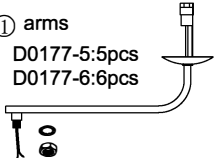

② lock nut & teeth lock washer
D0177-5:5pcs
D0177-6:6pcs

⑥ connect tube 1pcs

③ cover plate 1pcs

④ bottom box 1pcs

⑤ end cap 1pcs

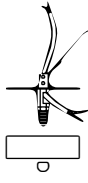

⑧ hanging tube 4pcs

⑦ splicing connector 2pcs

⑨ grub screw 1pcs

⑩ hex key 1pcs

⑮ cylinder tubes
D0177-5:5pcs
D0177-6:6pcs

⑪ canopy 1pcs

⑫ cap nut 2pcs

X 1PCS

X 1PCS

X 3PCS

X 3PCS

X 3PCS

X 3PCS

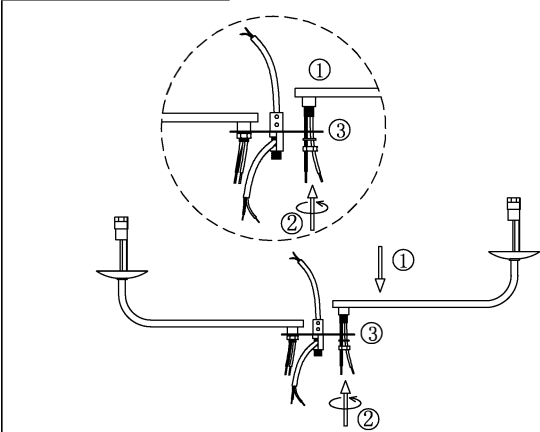

1. Install the arms ① on the plate ③ with lock nut & teeth lock washer ②.

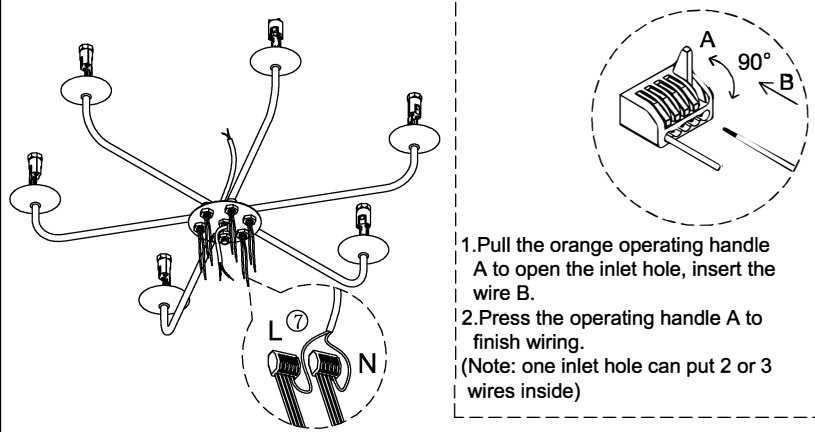

2. Connect all the wires by parallel with connectors ⑦ (all live line-L use one connector, and neutral Line-N use another connector).

1. Pull the orange operating handle A to open the inlet hole, insert the wire B.
2. Press the operating handle A to finish wiring.
(Note: one inlet hole can put 2 or 3 wires inside)

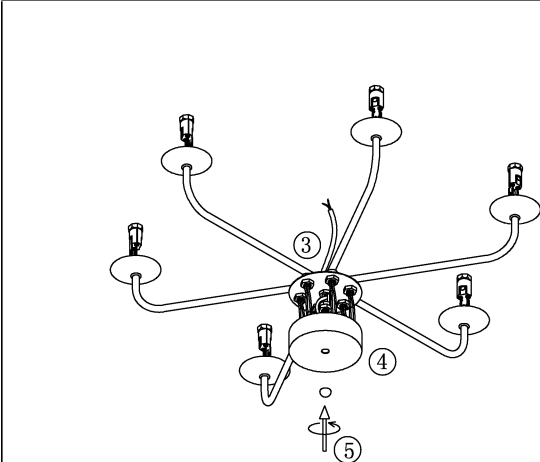

3. Install the box ④ to the plate ③ with end cap ⑤.

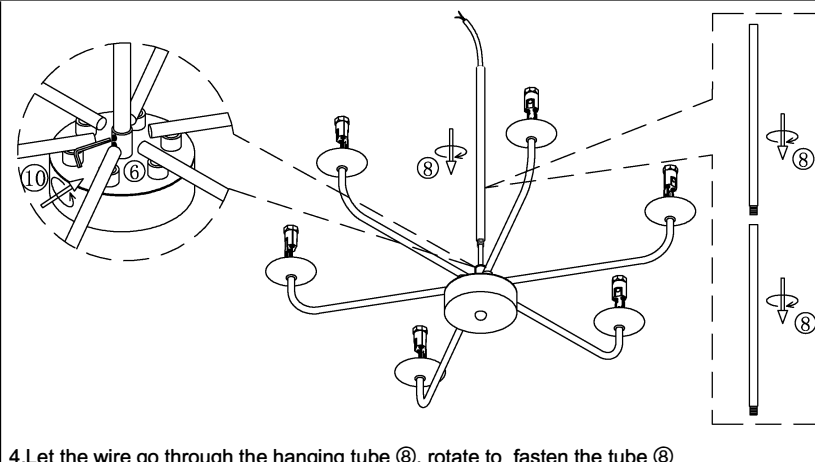

4. Let the wire go through the hanging tube ⑧, rotate to fasten the tube ⑧ to the connect tube ⑥, lock the tube ⑧ with grub screw ⑨ by rotate hex key ⑩. (can connect more tubes to get the height you need).

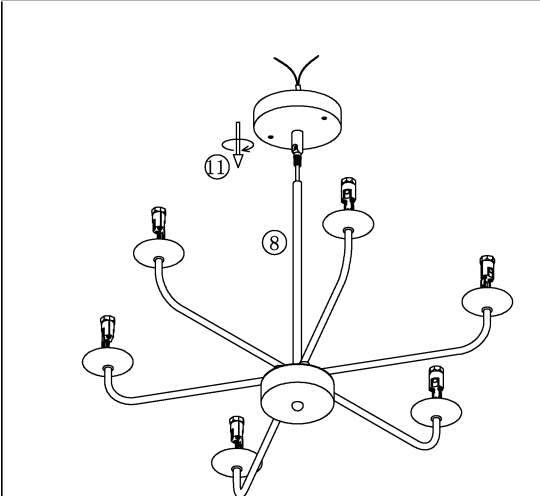

5. Let the wire go through the canopy ⑪, rotate to install the canopy to the tube ⑧.

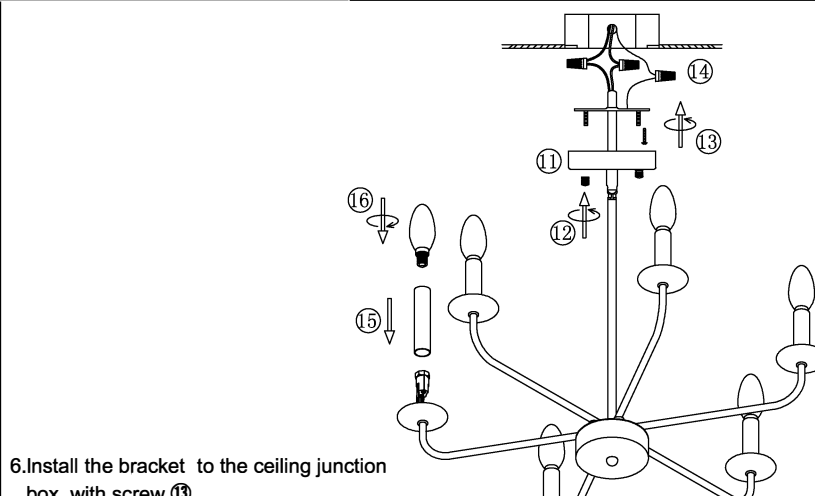

6. Install the bracket to the ceiling junction box with screw ⑬.

7. Connect the wire to your home line ⑭.

8. Install the canopy ⑪ to the bracket with cap nut ⑫.

9. Put the cylinder tubes ⑮ on the lampholder and install the bulbs ⑯.

Please read carefully before installation!!!

Note : Please make sure that the electricity is powered off during installation !

Only a professional electrician should install this kind of product !