











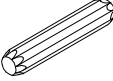

| | |
|---|---|
| <p>K 4*20</p>  <p>4PCS</p> | <p>L</p>  <p>4PCS</p> |
| <p>A</p>  <p>22PCS</p> | <p>B</p>  <p>22PCS</p> |

| | | | | | | | |
|--|--|---|--|--|---|--|--|
| <p>C 8*40</p>  <p>16PCS</p> | <p>D 3.5*14</p>  <p>52PCS</p> | <p>E</p>  <p>4PCS</p> | <p>F</p>  <p>2PCS</p> | <p>G 568mm</p>  <p>1PCS</p> | <p>H</p>  <p>10PCS</p> | <p>I 3*12</p>  <p>10PCS</p> | <p>J</p>  <p>4PCS</p> |
|--|--|---|--|--|---|--|--|

1

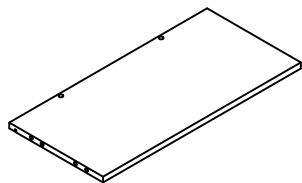

570*270 1PS

2

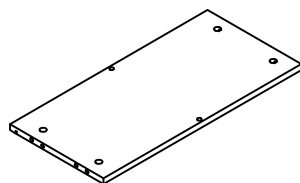

570*270 1PS

3

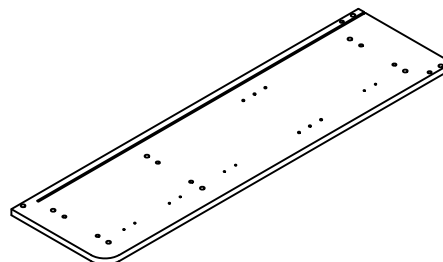

1000*270 1PS

4

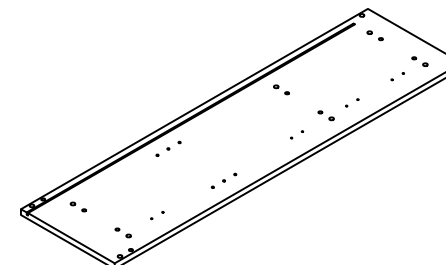

1000*270 1PS

5

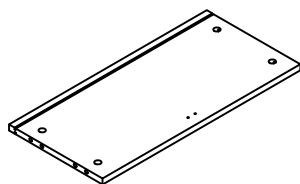

570*270 1PS

6

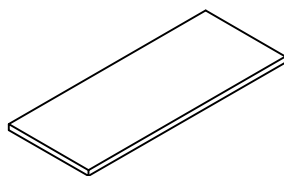

567*230 1PS

7

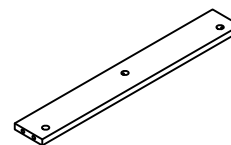

570*80 2PS

8

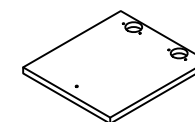

251*282 2PS

9

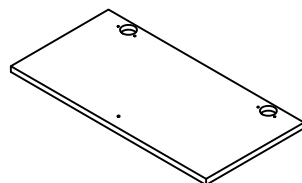

563*282 2PS

10

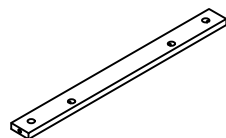

570*50 1PS

11

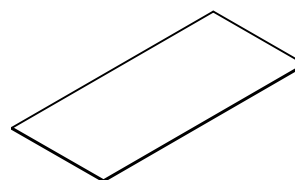

580*263 1PS

12

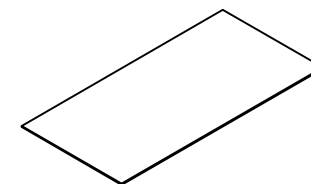

580*288 2PS

"A" Hardware installation example

I

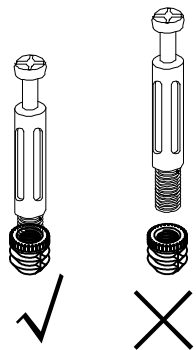

This part cannot be separated,
please install in strict
accordance with the assembly
requirements

II

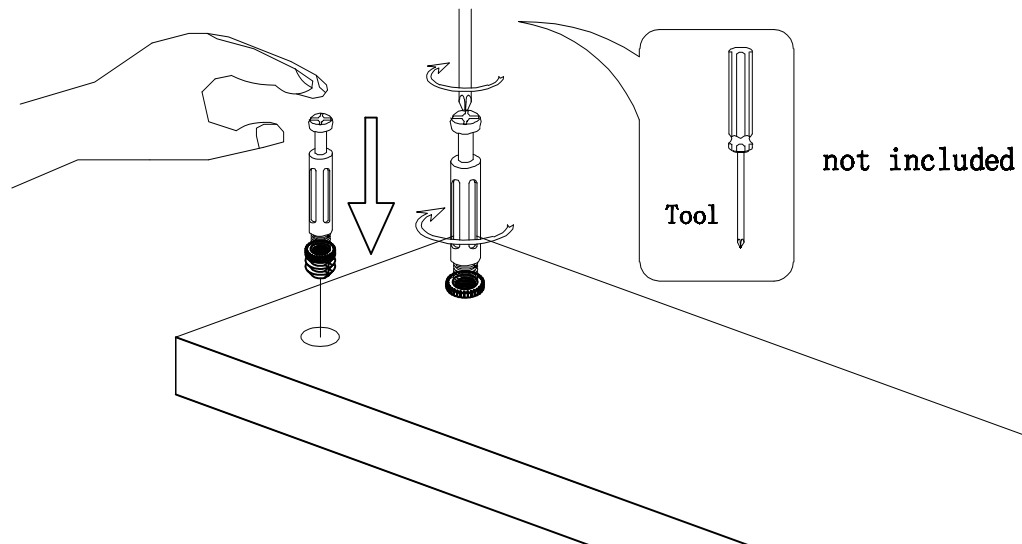

III

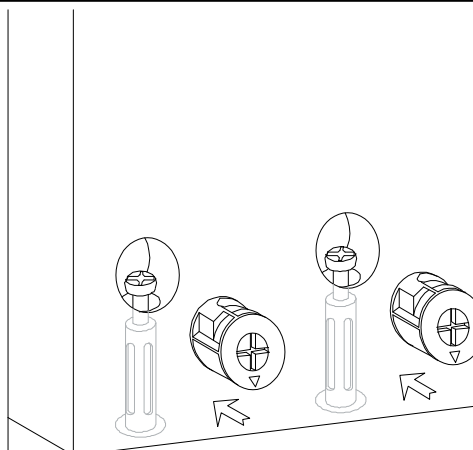

IV

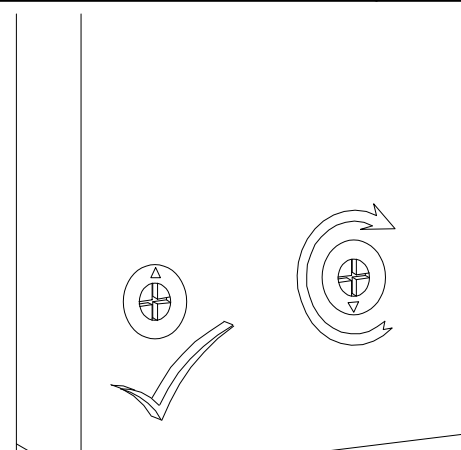



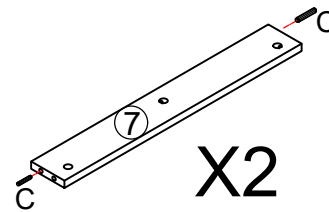
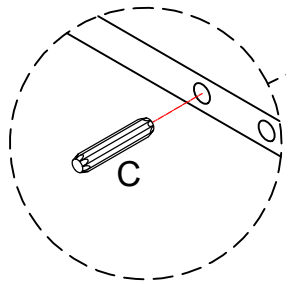
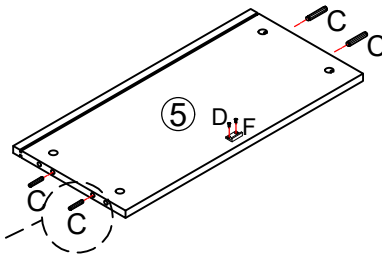
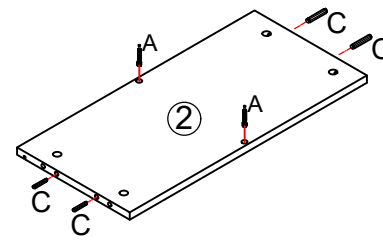
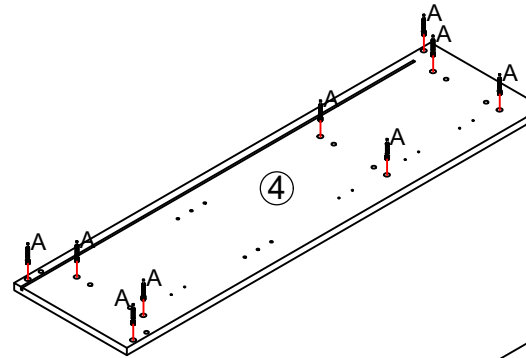
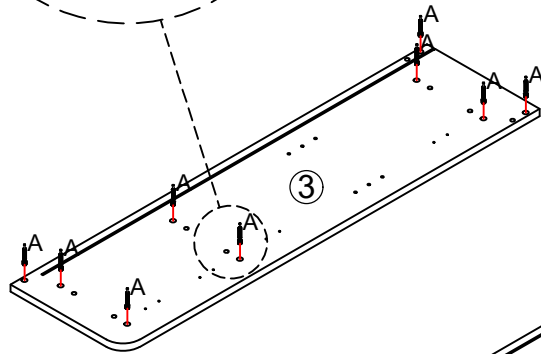
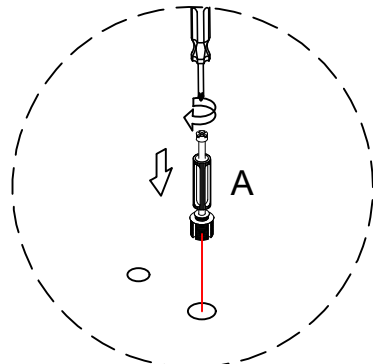

1

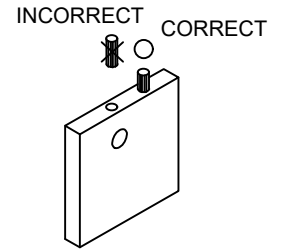
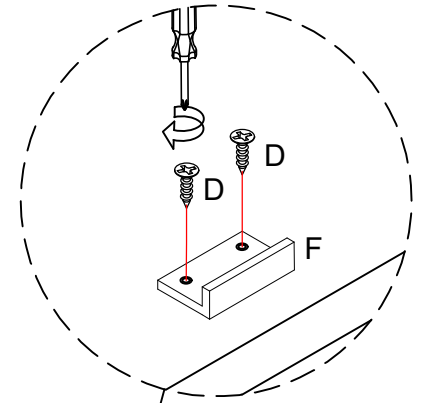
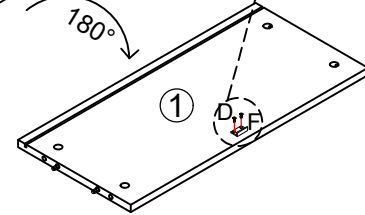
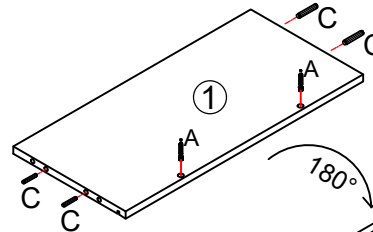

X2



| | |
|---|------|
|  | A*22 |
|  | C*16 |
|  | D*4 |
|  | F*2 |

put A on board ①②③④
 put C on board ①②⑤⑦

2

Make sure the arrow on the screw align to the hole on the side.

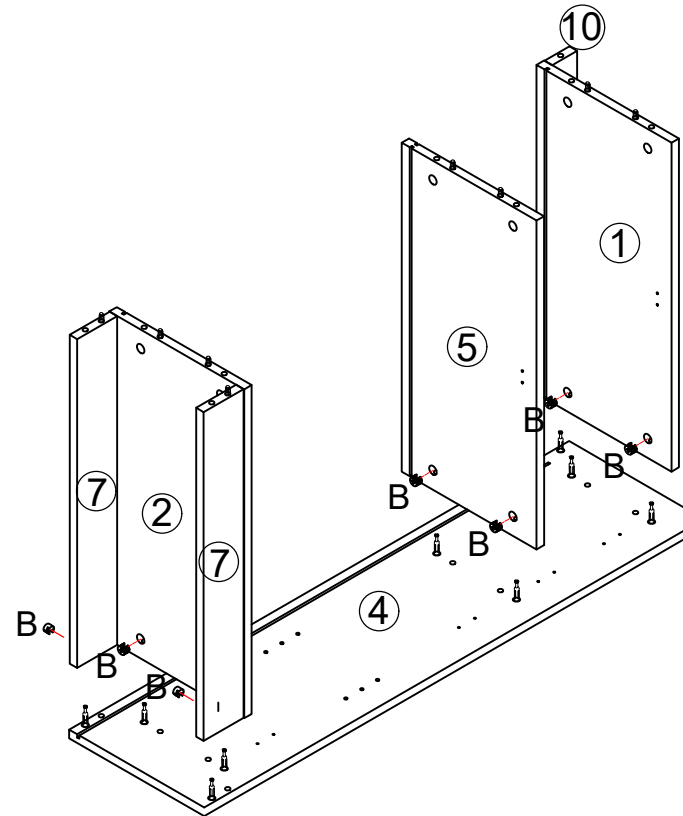
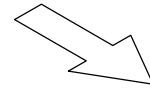
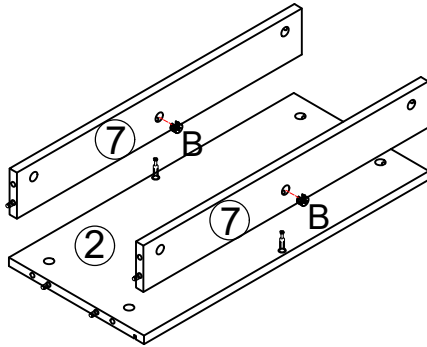
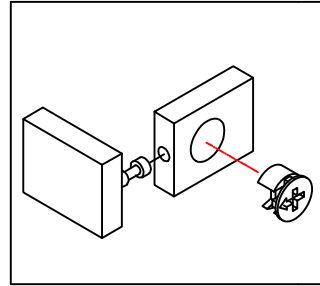
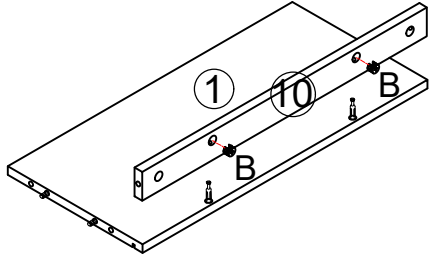

B*13

put B on board ①②⑤⑦⑩

4

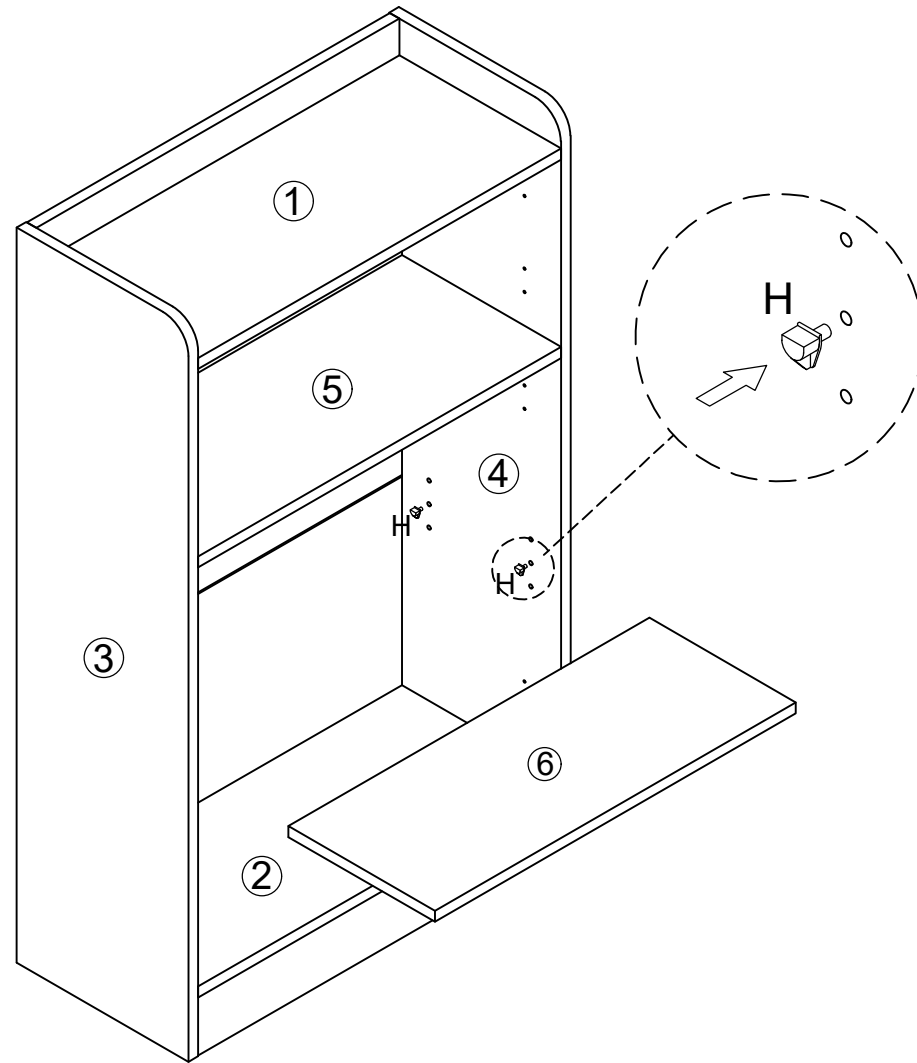

H*4

5

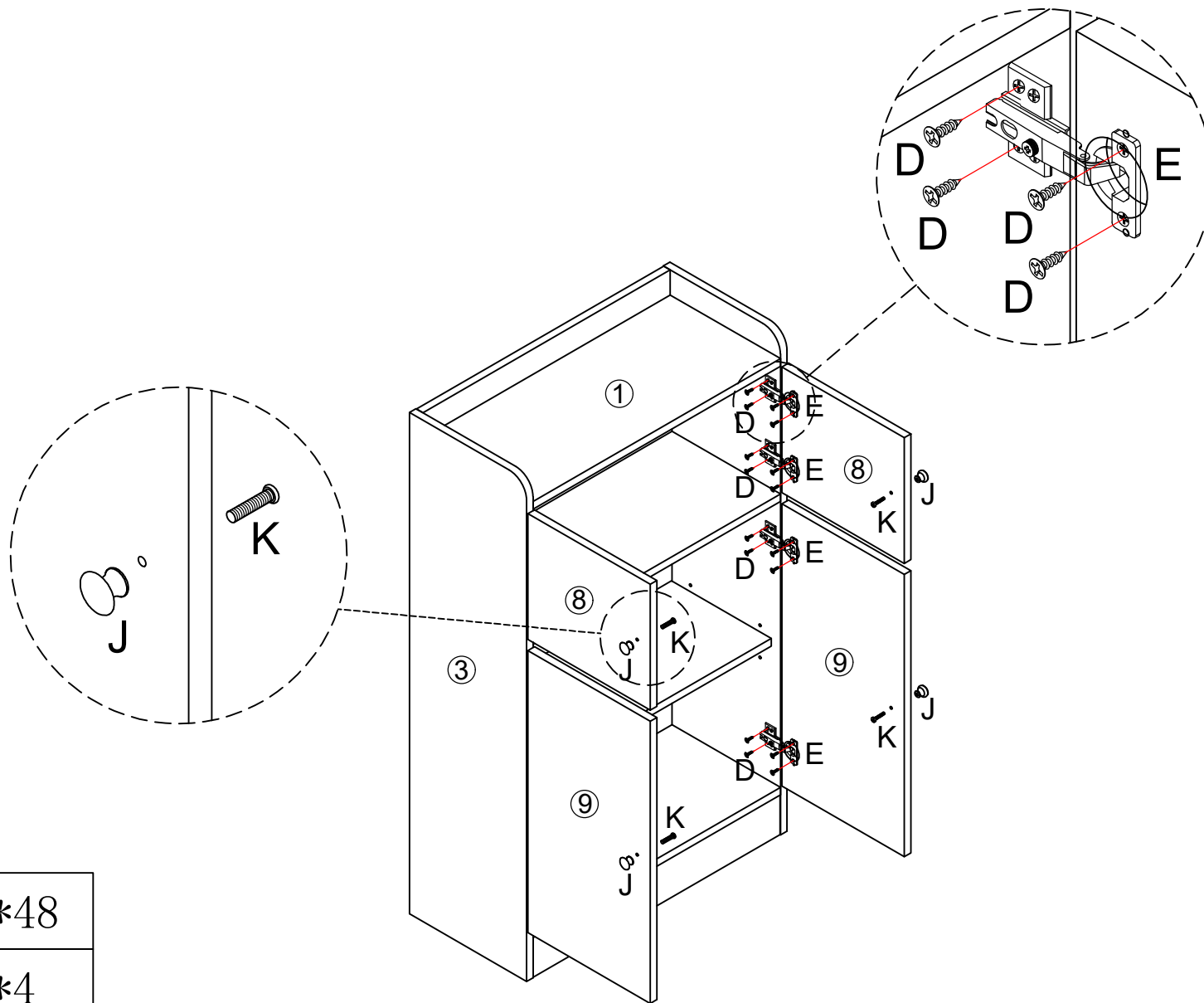

D*48



E*4



J*4



K*4

6

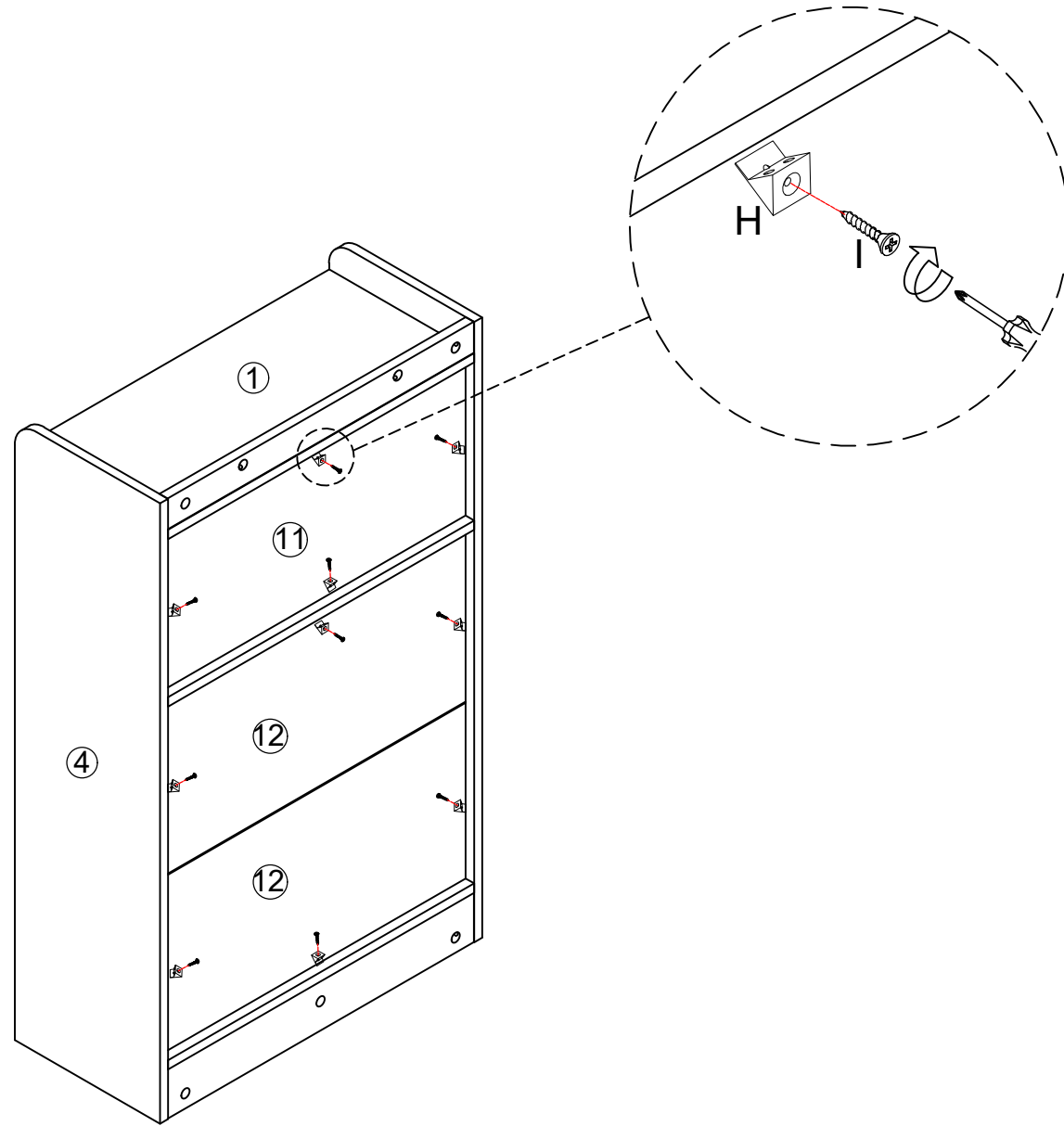

H*10



I*10

END

