

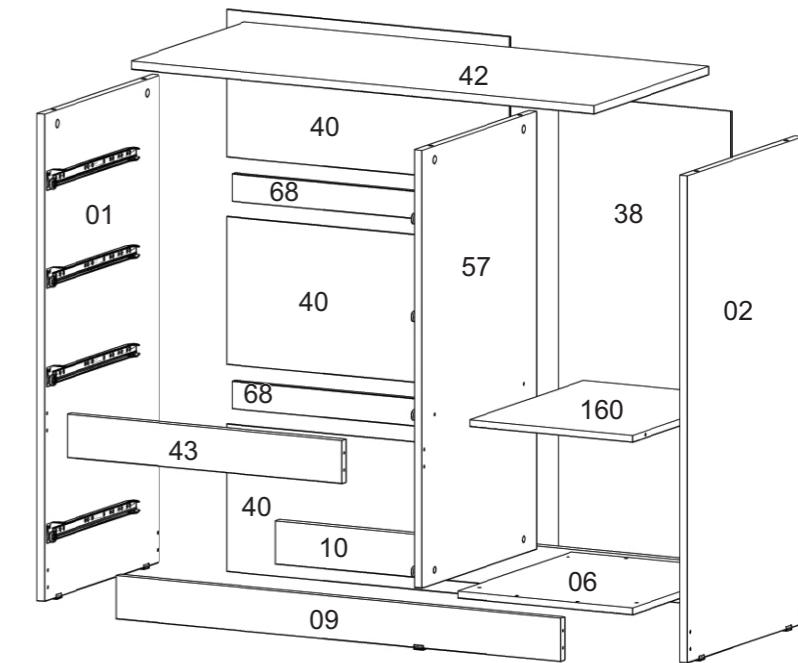

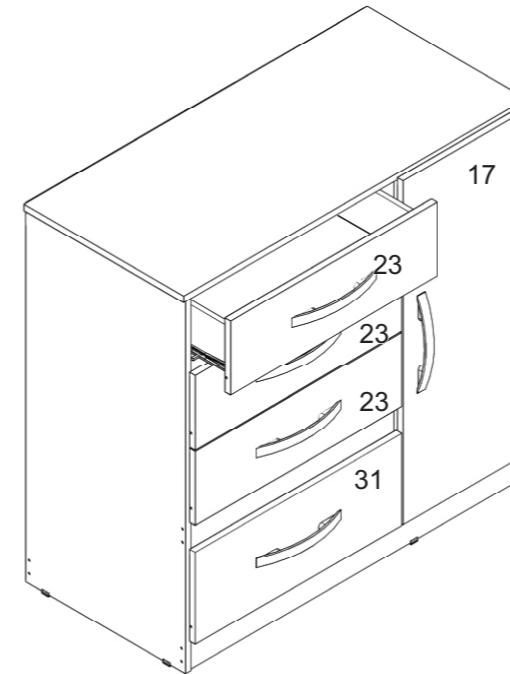









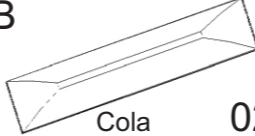
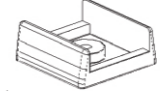









Descrição DESCRIPTION	qt. AMOUNT	Item PART	Comp.	Larg.
Lateral esquerda/Lateral Izquierda/Left Side	1	01	910	450
Lateral Direita/Lateral Derecha/Right Side	1	02	910	450
Quadro Base/Cuadro Base/Base Square	1	06	365	450
Rodapé Frontal/Zocalo Frontal /Front Baseboard	1	09	927	80
Rodapé Traseiro/Zocalo Trasero/Back Baseboard	1	10	927	80
Porta Inteira/Puerta Larga/Biggest Door	1	17	840	350
Lateral da Gaveta/Lateral De La Cajonera/Side Drawer	8	22	350	109
Frente de Gaveta/Frente De La Cajonera/Front Drawer	3	23	582	180
Traseiro de Gaveta/Trasero Del Cajon/Back Drawer	4	26	526	80
Fundo de Gaveta/Fondo Del Cajon/Bottom Drawer	4	27	548	355
Frente de Gaveta Maior/Frente Del Cajon Larga/Front Drawer Greater	1	31	582	225
Traseiro/Trasero/Back	1	38	850	360
Fechamento das Gavetas/Cierre De Los Cajones/Closing Drawers	3	40	592	275
Tampo/Tampo/Cover	1	42	967	450
Sanefla/Sanefla/Sight	1	43	574	80
Divisória Central/División Central/Central Division	1	57	818	450
Coluna Traseira/Columna Trasera/Back Column	2	68	572	50
Prateleira móvel / Estante movil / mobili shelf	1	160	340	433



Acessórios				
<b>A</b>  Bucha cilíndrica 02	<b>B</b>  Cola 02	<b>C</b>  Sapata 06	<b>D</b>  Tapa furo 5,6 02	<b>E</b>  Tampa plastica 04
<b>F</b>  Fixador Reto 07	<b>G</b>  Dobradiça 02	<b>H</b>  Calço da Dobradiça 02	<b>I</b>  Fixador L 08	<b>J</b>  Parafuso 3,5 x 16 16
<b>K</b>  Parafuso 4,0 x 50 14	<b>L</b>  Parafuso 3,5 x 25 10	<b>M</b>  Parafuso 4,0 x 12 24	<b>N</b>  Parafuso 3,5 x 40 20	<b>O</b>  Parafuso 3,5 x 12 24
<b>P</b>  Prego 10 x 10 65	<b>Q</b>  Cavilha de Madeira 16	<b>R</b>  Castanha de girofix 06	<b>S</b>  Pino de girofix 06	<b>T</b>  Puxador 05
<b>U</b>  Corrediça 04	<b>V</b>  Corrediça 04	<b>X</b>  Suporte Prateleira 04		

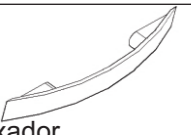
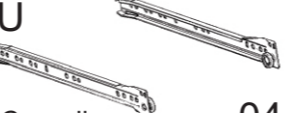
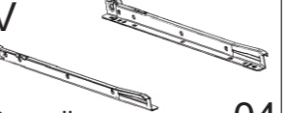