















# Part list "IMPORTANT, RETAIN FOR FUTURE REFERENCE: READ CAREFULLY"

A		B		C		D		E		F		G		H	
Threaded nipple 3 / PCS	Plastic anchor 2/PCS	Fixed metal plate 1/PCS	Pointed screw 2/PCS	Nut 2/PCS	Antiskid spacer 3/PCS	Spacer 2/PCS	Ceiling metal panels 1/PCS								
I		J		K		L		M		N		O			
Flat screw 4/PCS	Mounting screws 2/PCS	Loop 4/PCS	Chain 2/PCS	Screw rods 2/PCS	Shade with Socket 1/PCS	Green ground screw 1/PCS									

## Installation

**Step 1:** Remove the flat screw ( J ) from ceiling metal panels ( H ). Then attach the fixed metal plate ( C ) to the outlet box with the mounting screws ( J ). The one marked GND must face outwards.

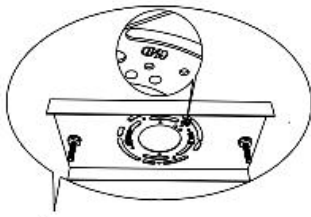

**Step 2:** Cut the length of wire when needed. The remaining wire will be at least 6" long measured from the top of the Ceiling metal panels ( H ).

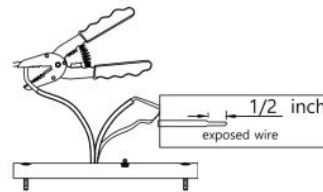

**Step 3:** Pay attention to connecting the wires. Be sure to differentiate between positive and negative points. Positive to positive, negative to negative, and ground to ground.

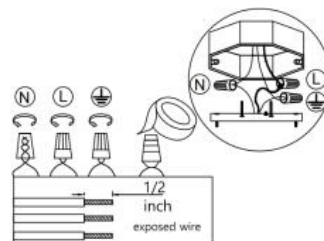
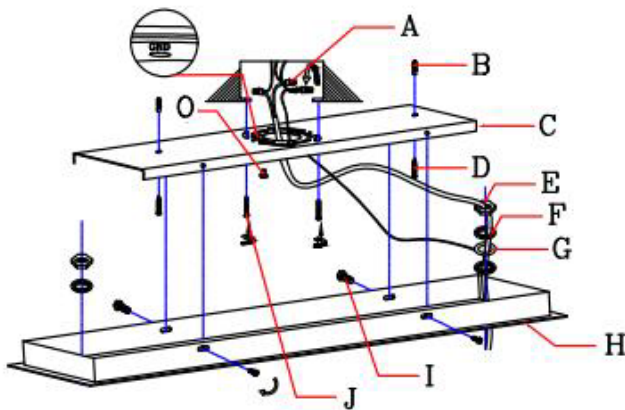

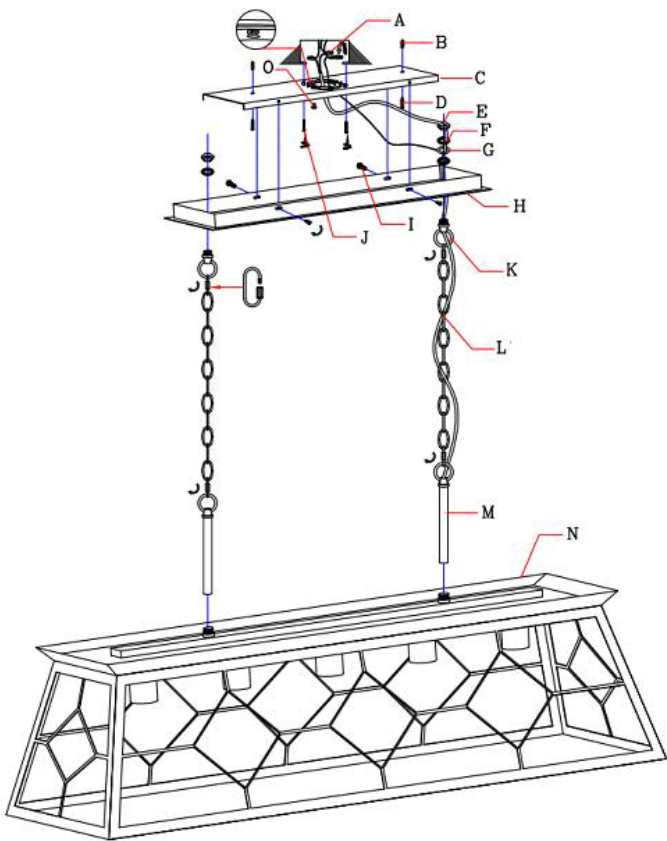

**Step 4:** Install two loops(K) on the ceiling metal plates (H) tightly.

**Step 5:** Screw ceiling metal panel(H) on the fixed metal plate(C) by 4pcs flat screws(I) tightly.

**Step 6:** Screw rods(M) on the shade(N), tighten the rods by the loop(K).

**Step 7:** Screw rods(M) on the shade(N), tighten the rods by the loop(K).

**Step 8:** Install bulbs. (Bulbs not included).

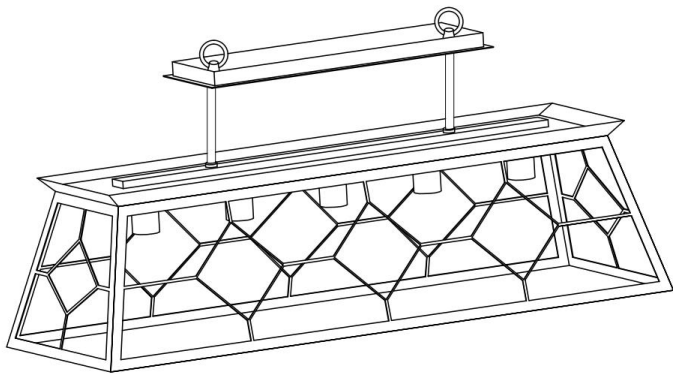

**Note:** It can be used as the ceiling lamp without the chain (L)

**Installation Completed**