

## Instructions for Use



Up and down adjustment

















Tilt adjustment

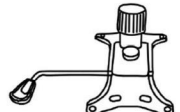

Backrest adjustment

Thanks for purchasing our products. Please read this manual before assembly.  
And please assemble in order. After the assembly, keep the instruction properly.  
Make sure all the parts are concluded (15 kinds in total).

## Accessories List

(1) Backrest 	(2) Seat Cushion 	(3) Split Base Tube Central Base Tube 	(4) 5 Castors 	(5) Air Rod 
(6) 2 Armrests 	(7) Base Plate 	(8) 4 Screws (M6X35mm) 	(9) 6 Screws (M6X30mm) 	(10) 4 Screws (M6x25mm) 
(11) 5 Screws (M6x20mm) 	(12) Allen Drive 	(13) 4 Decoration Caps 	(14) Headrest 	(15) Decorative Cover 

## Notice

- This is a single chair, so please do not seat 2 or more persons, just seat only one person.
- Do not stand on the chair.
- Do not sit reverse or sit outside of the seat cushion.
- Check the screws once every 6 months, to make sure the screws are tight. Do not use the chair when the screws are loose.
- Please assemble according to the instructions.

## Assembly Instruction

Please assemble in a wide and flat place.

### Step 1

Take out Split Base Tube (3) and Central Base Tube(3). Insert Split Base Tube (3) into Central Base Tube (3) as shown. You can see there are two screw holes. Align with the holes, tighten Screws M6X20mm (11) with Allen Driver (12) to fix 5 Split Base Tube (3) to Central Base Tube (3). Repeat five times.

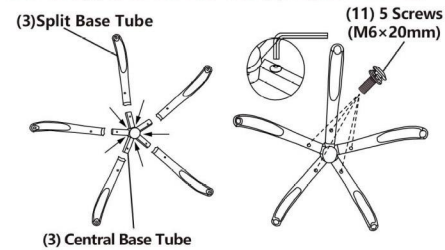

### Step 2

Take out Air Rod (5). Insert Air Rod (5) into the hole of Central Base Tube (3) as shown. Put it aside and we'll use it in Step 6. Confirm Castors (4) must be inserted deeply. (Press the castors in with more force)

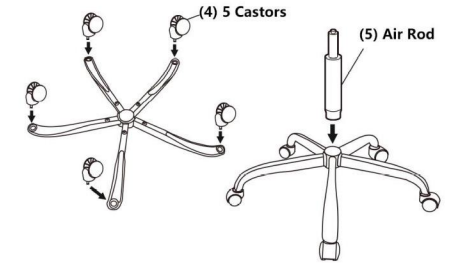

### Step 3

Tighten the Screws M6X30mm (9) with Allen Drive (12) to fix 2 Armrests(6) to the back of Backrest(1). Tighten the 4 screws firmly and then cover the screws with Decoration Caps (13). Tighten the Screws M6\*30mm (9) with Allen Drive (12) to fix Headrest (14) to Backrest (1) and then cover the screws with Decorative Cover. (15).

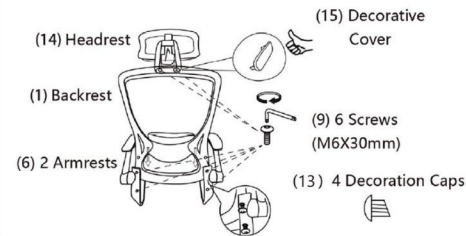

### Step 4

After Step 3, fix the bottom of Armrests (6) to the back of Seat Cushion (2). Tighten the Screws M6X35mm (8) with Allen Drive (12) firmly.

\* Caution: There is a FRONT sticker on the front of Seat Cushion (2)

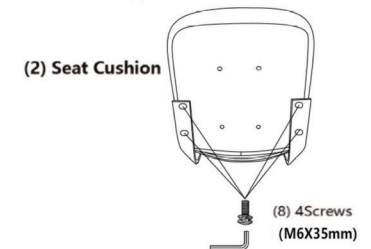

### Step 5

Fix Base Plate (7) to the bottom of Seat Cushion (2). Tighten the Screws M6x25mm (10) with Allen Drive (12) firmly.

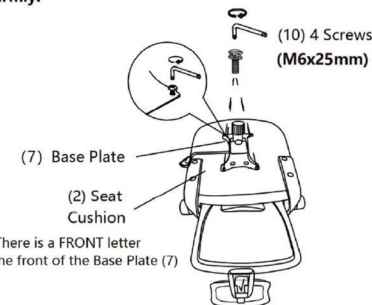

Caution: There is a FRONT letter print on the front of the Base Plate (7)

### Step 6

Pick up the Step 2's Air Rod (5) and Central Base Tube . Insert the Air Rod (5) into Step 5's Base Plate (7). There's a hole in the middle of Base Plate (7). Press the Seat Cushion (2) from top to bottom, use your whole body's strength to insert it firmly. the assembly is complete now.



\* Caution: If the Air Rod (5) doesn't insert to Base Plate (7) firmly, it's likely to fall off when the chair raises up.