

30Mins

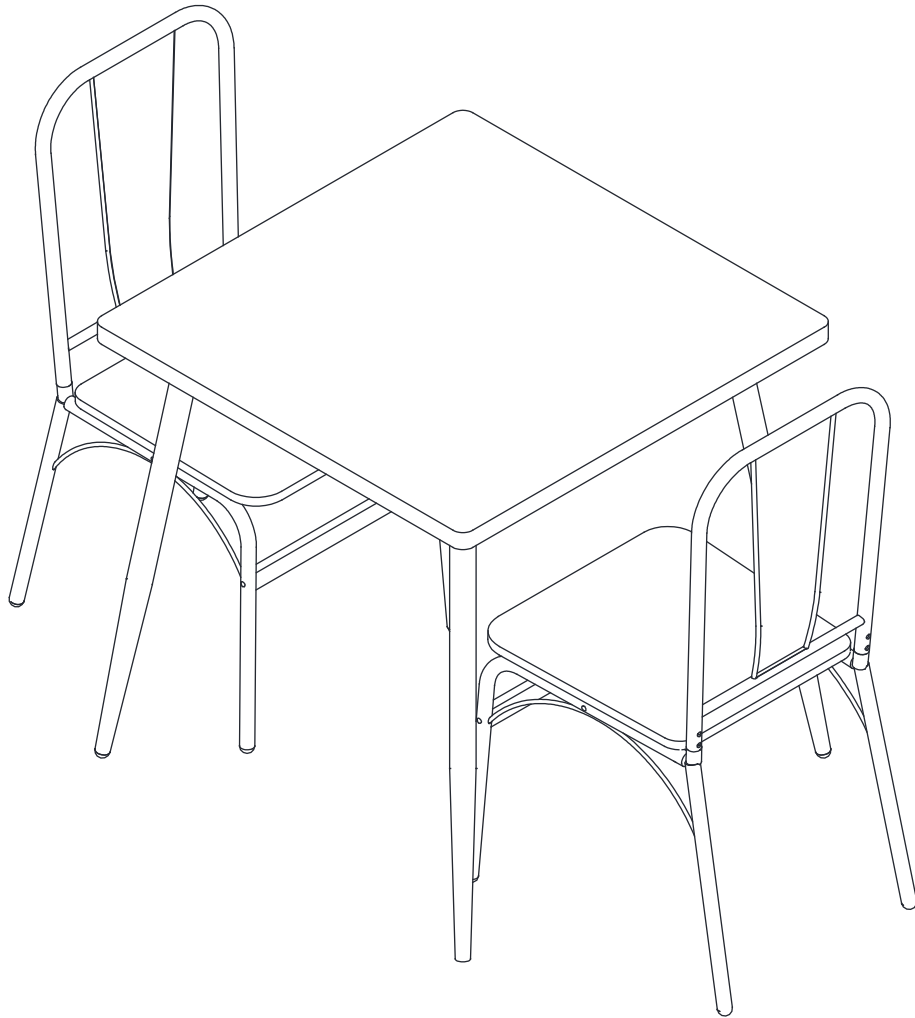

x2



CUSTOMER FIRST, SERVICE FOREMOST!

Questions? Issues?









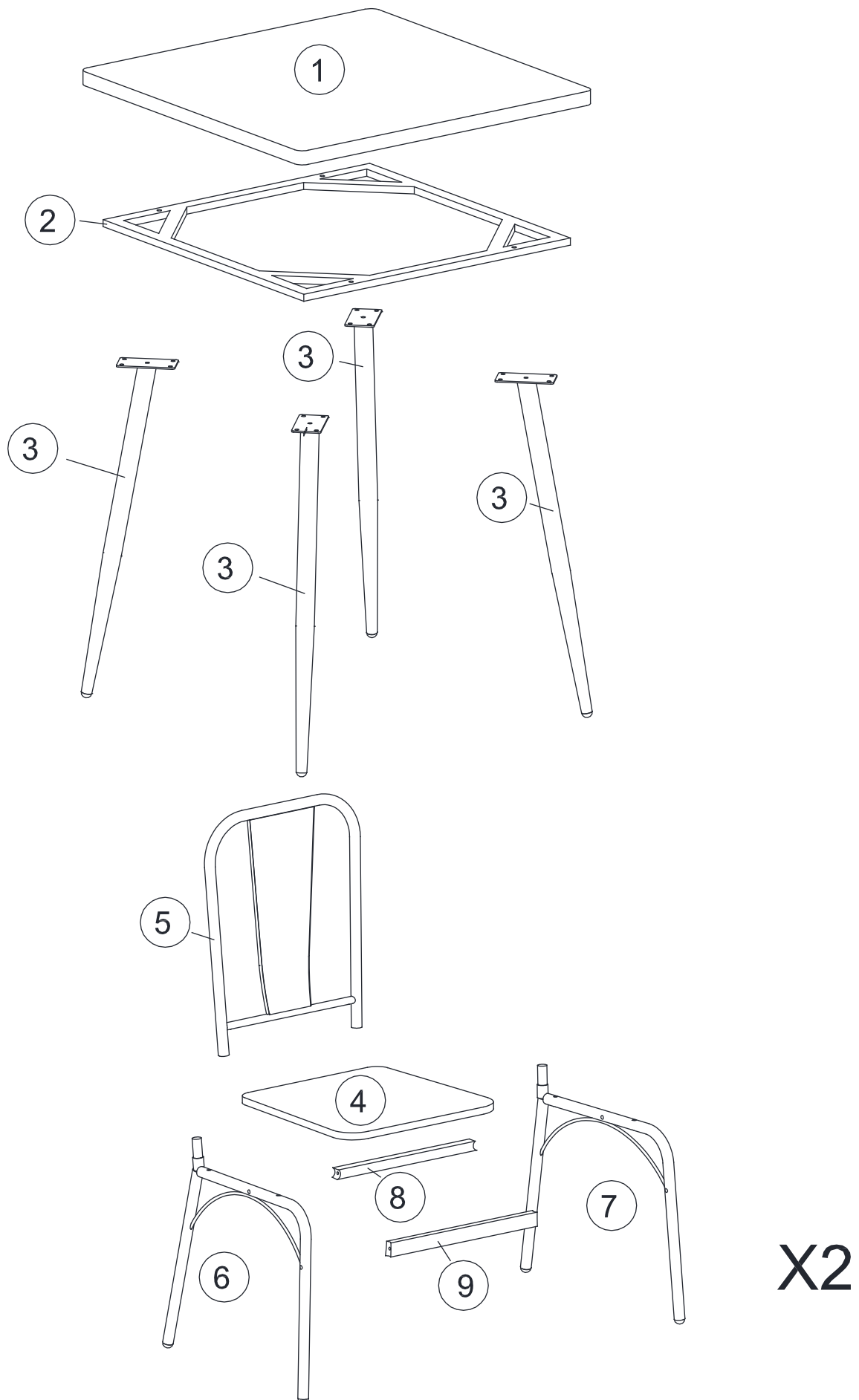

CONTACT US

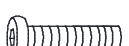

REPLY WITHIN 24 HOURS IN BUSINESS DAYS

Exploded View

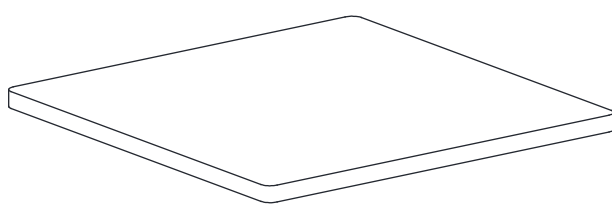
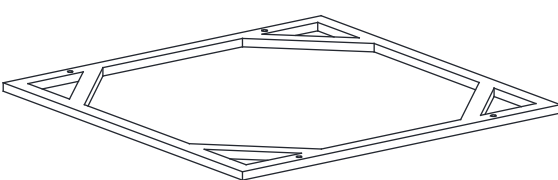
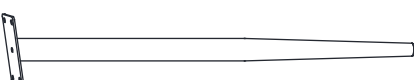
Note: When assembly, do not tighten the screws one by one first until making sure all the corresponding screws are placed in the right positions.

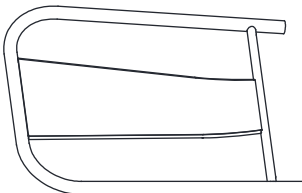

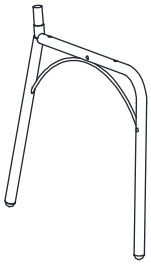
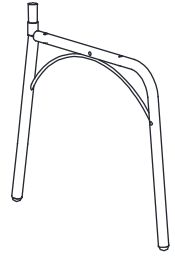
Label	Part Image	Description	Qty
A		M4 Allen Key	x1
B		M5 Allen Key	x1
C		Screws Gasket	x8
D		M6x12mm	x24
E		M6x30mm	x8
F		M6x40mm	x8
G		M8x35mm	x4
H		Spring Lock Washer	x8
①		Table Board	x1
②		Table Rack	x1
③		Table Leg	x4
④		Chair Board	x2
⑤		Chair Back	x2

Label	Part Image	Description	Qty
⑥		Chair Left Frame	x2
⑦		Chair Right Frame	x2
⑧		Back Connecting Bar	x2
⑨		Front Connecting Bar	x2

1

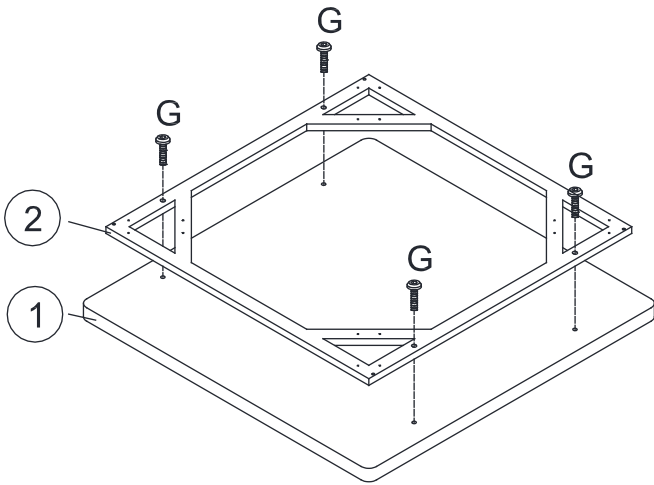

2

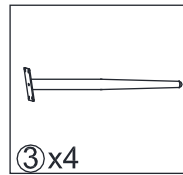
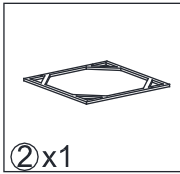
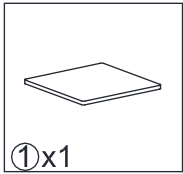
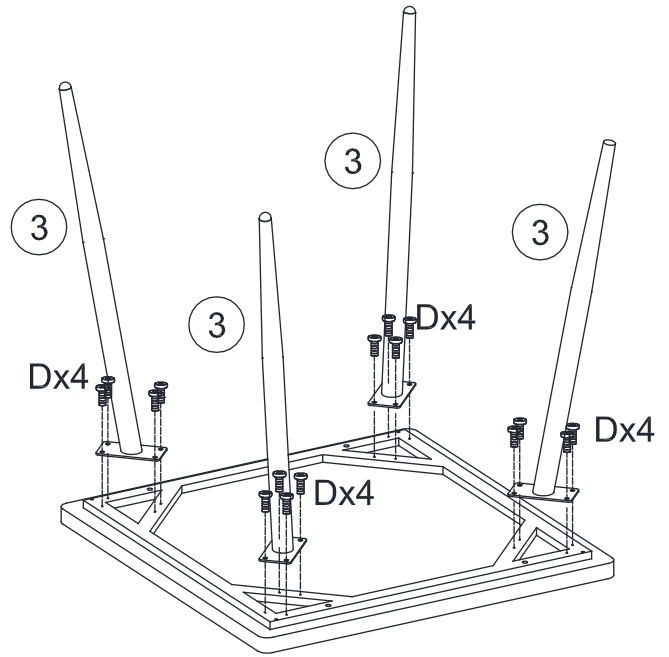

3

x2

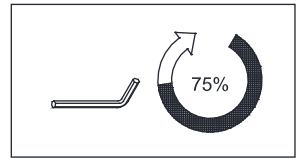

Please screw all the parts together at 75% tightness, it will help you assemble the sets easily.

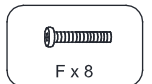
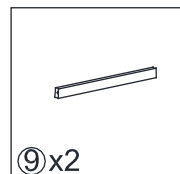
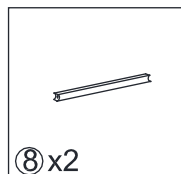
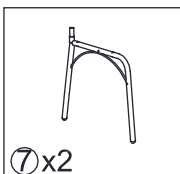
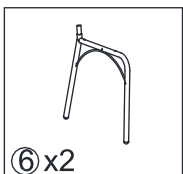
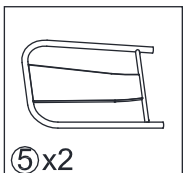
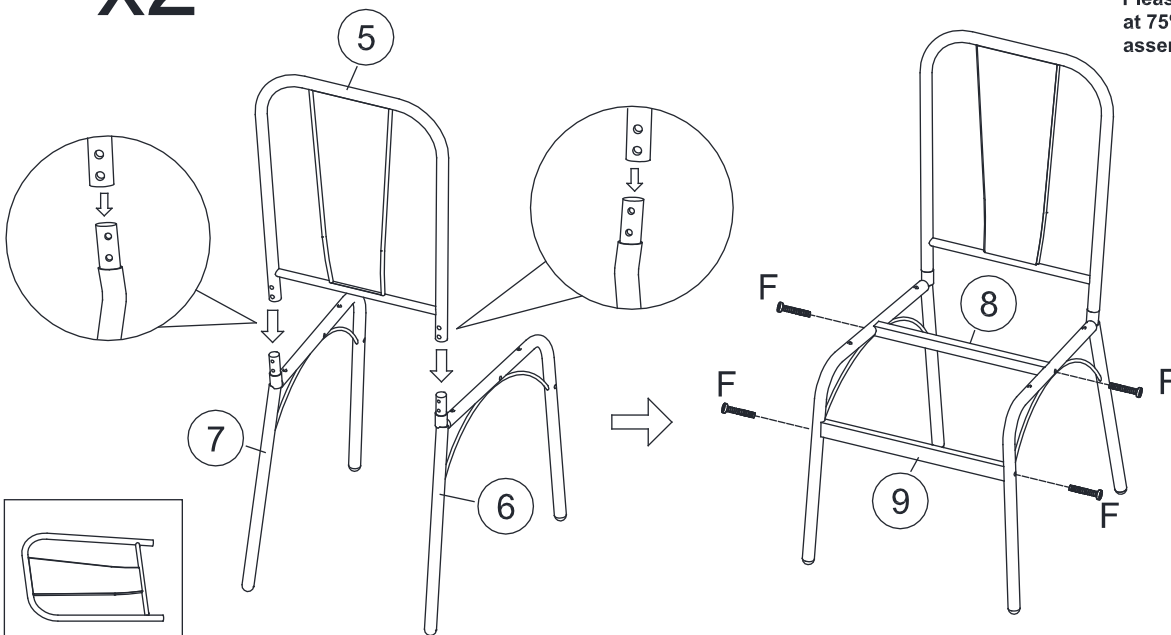

4

x2

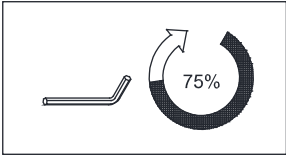

Please screw all the parts together at 75% tightness, it will help you assemble the sets easily.

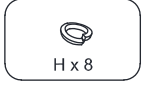
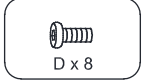
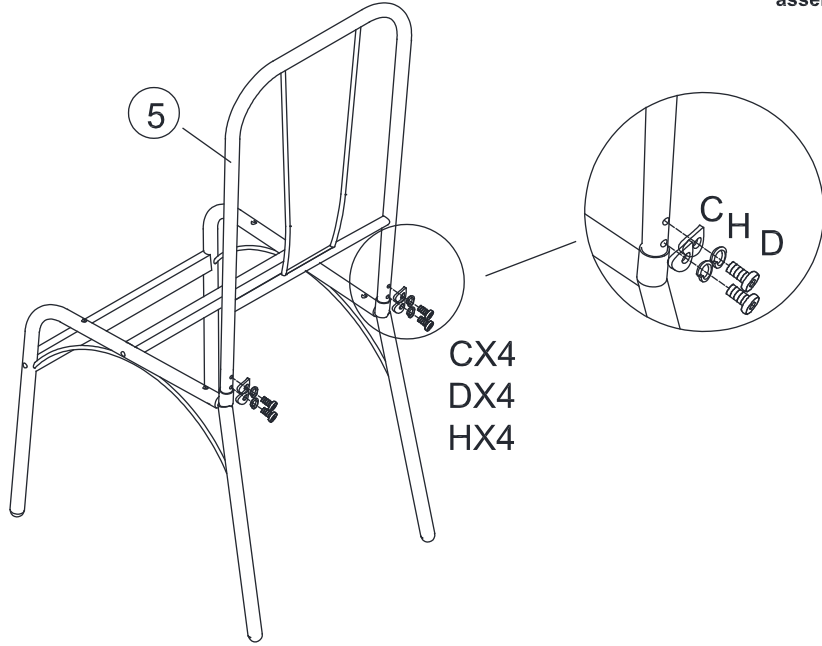

5

x2

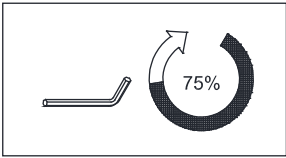

The silver color of the screw E is to prevent misuse with other screws.

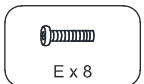
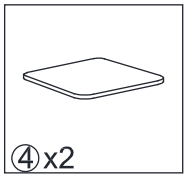
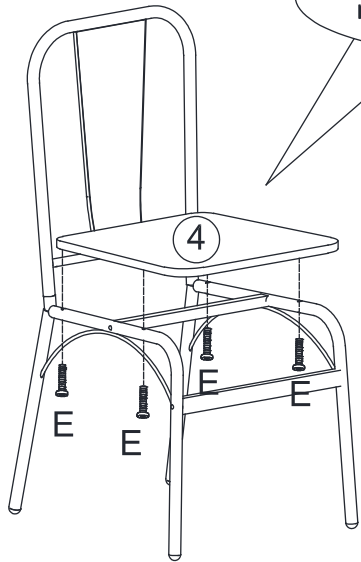

6



Before tightening the #4 chair board, press down on the board by hand to make sure all four feet are on the ground.

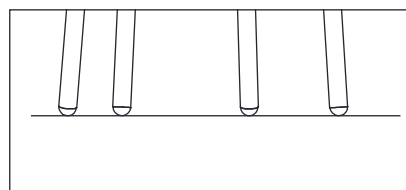
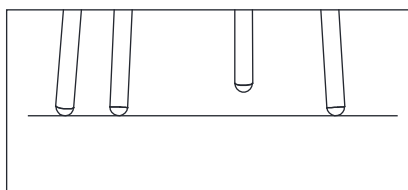
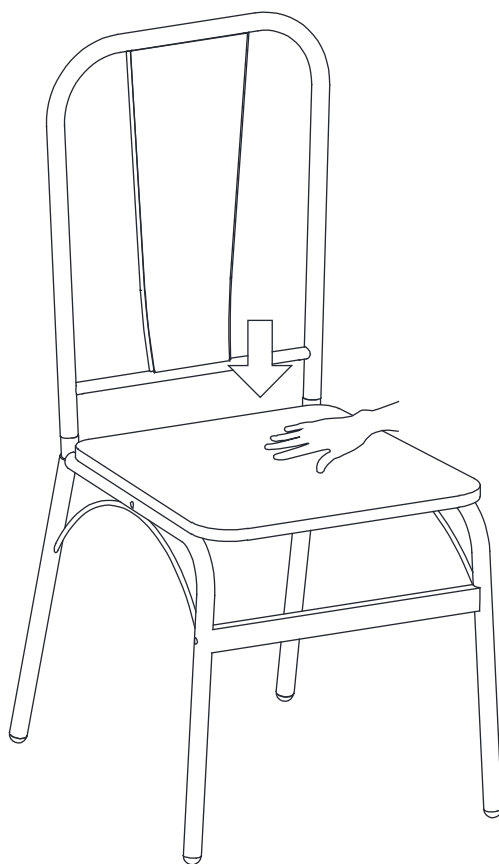

X

✓