

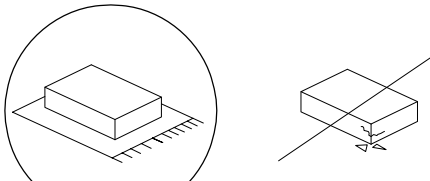

		30'
		
		1



A

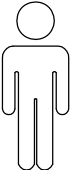
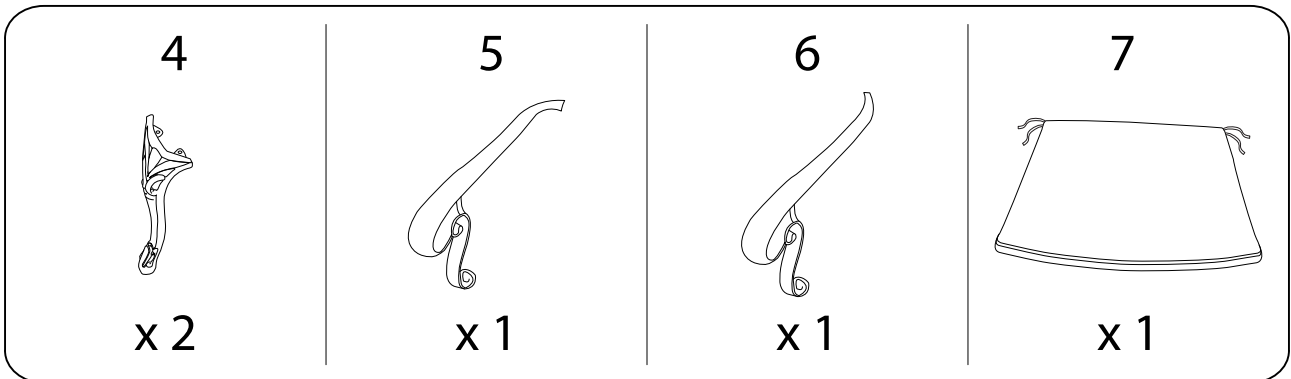
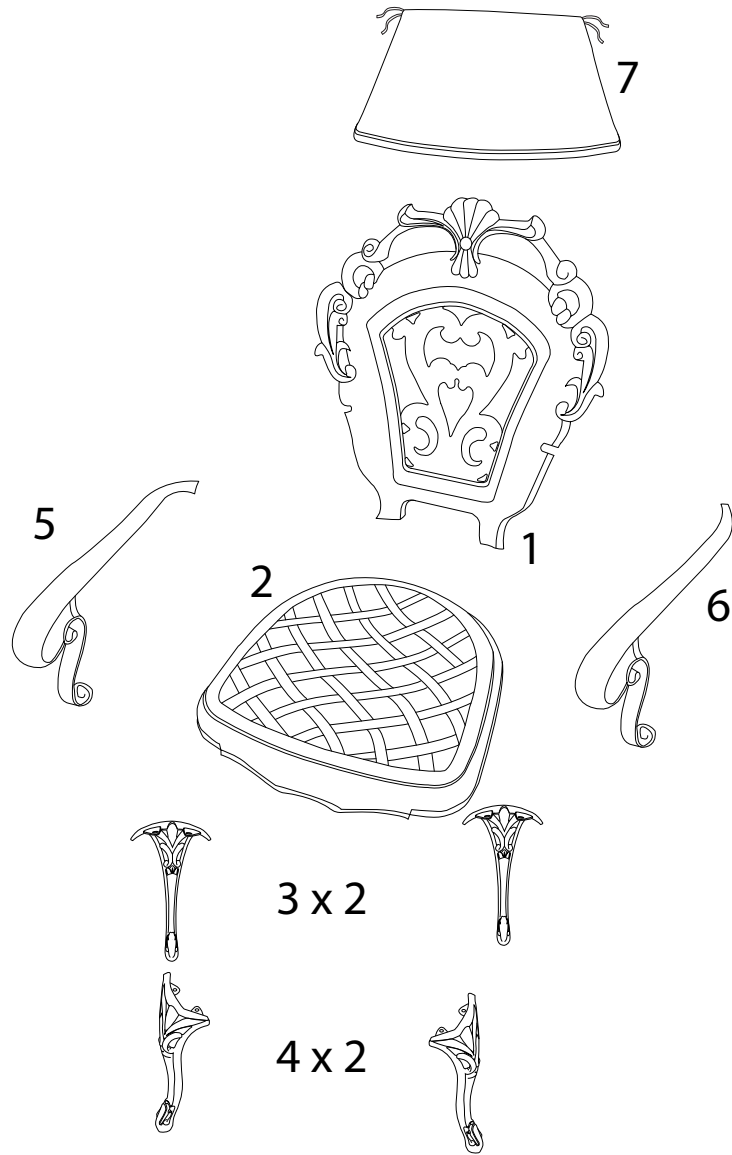
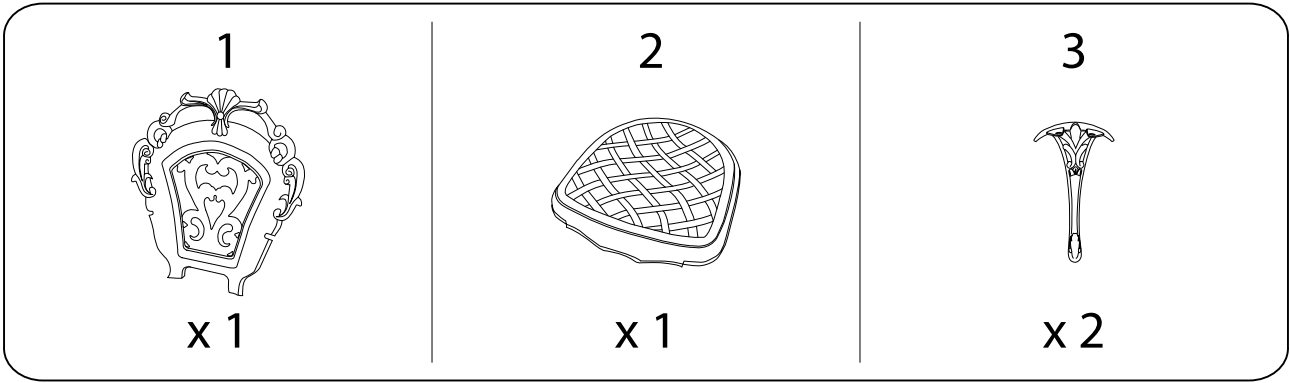
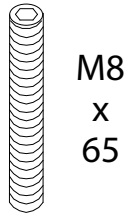

x 2

B

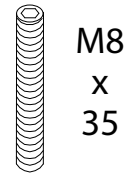

x 8

C

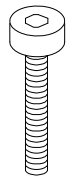

x 2

D

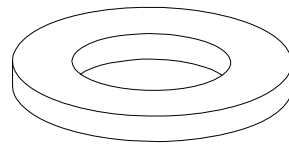

x 10

E

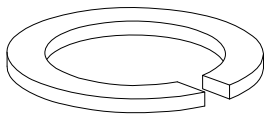

x 10

F

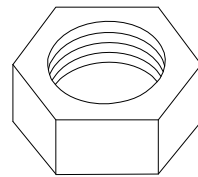

x 10

G

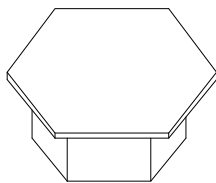

x 10

H

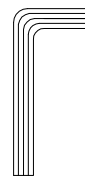

x 1

I

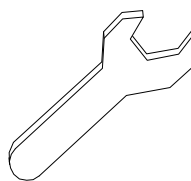

x 1

1

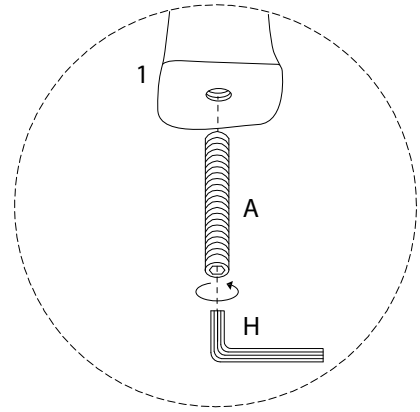
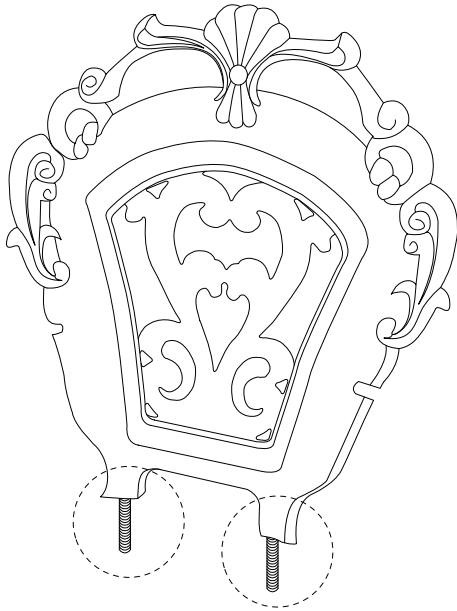
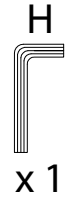
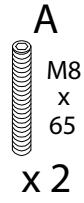

2

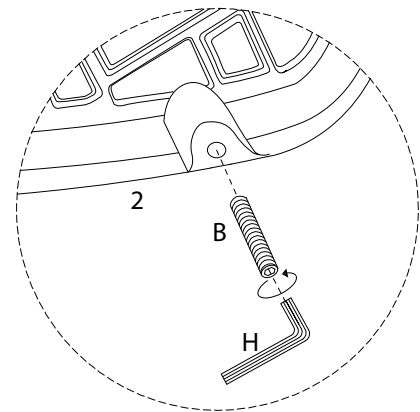
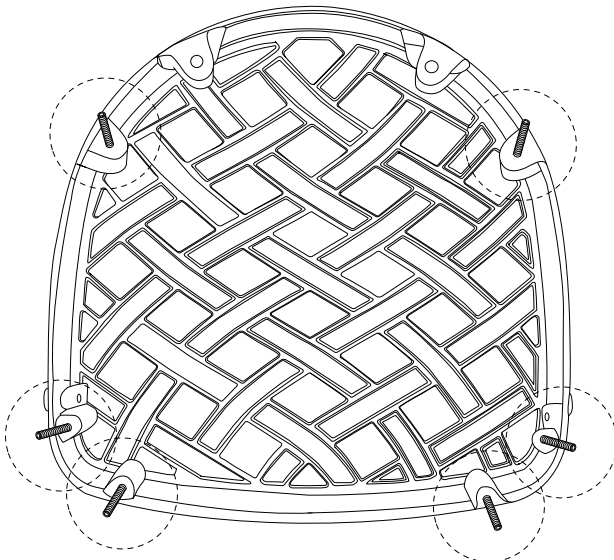
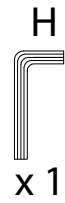
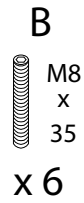
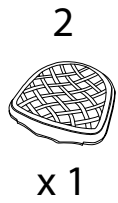

3

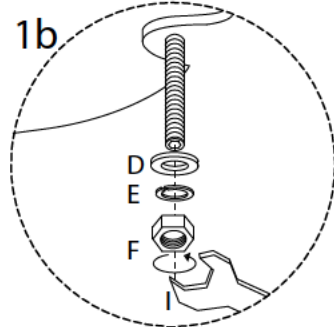
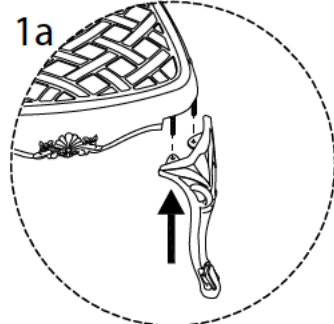
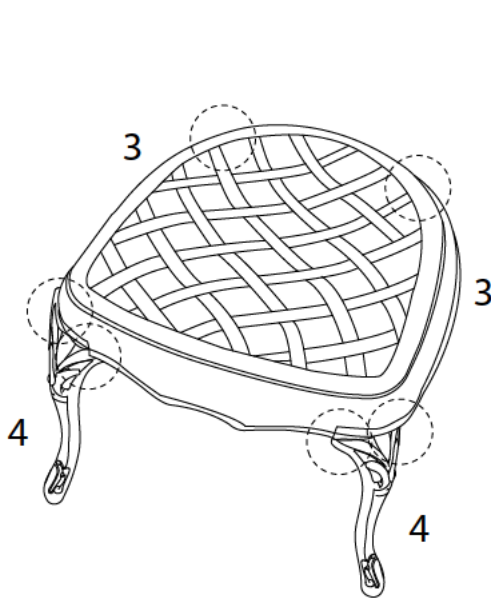
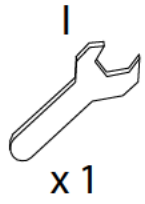
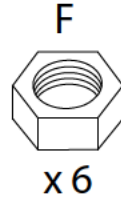
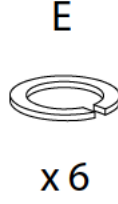
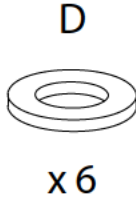

4

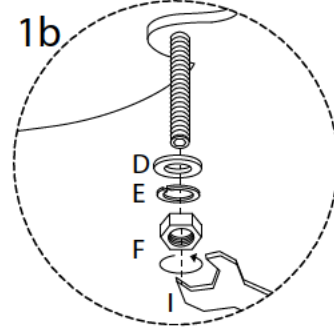
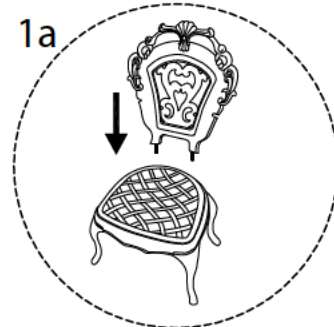
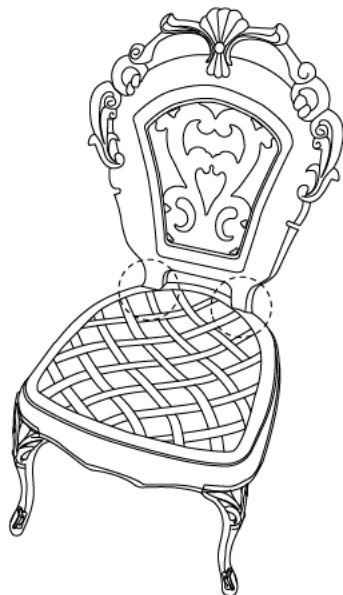
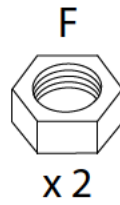
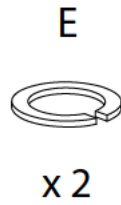
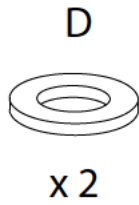

5

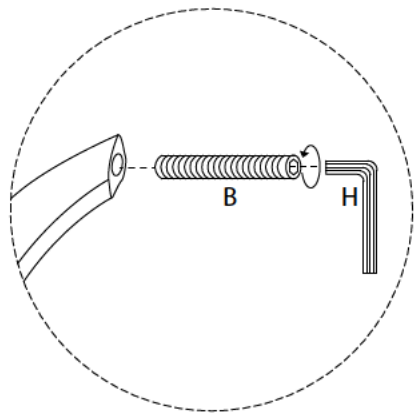
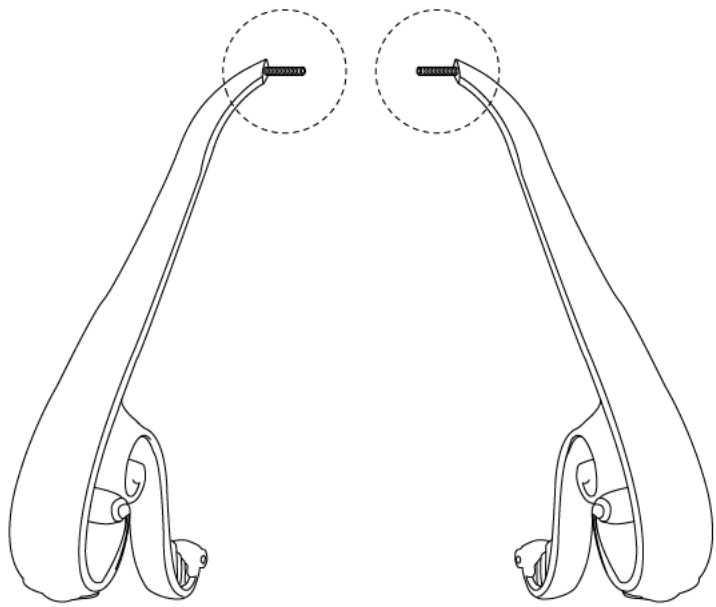
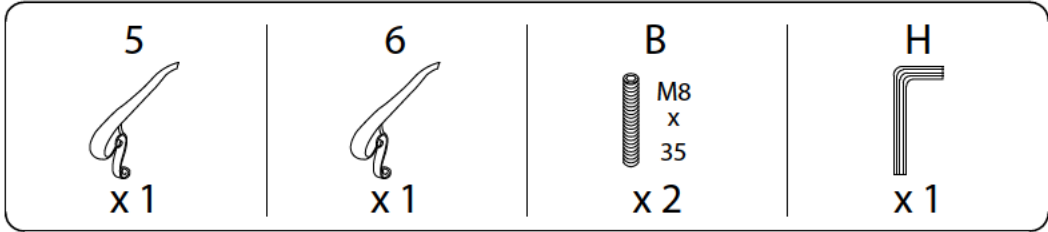

6

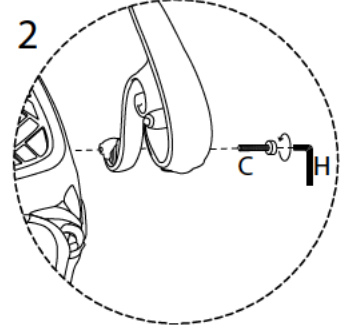
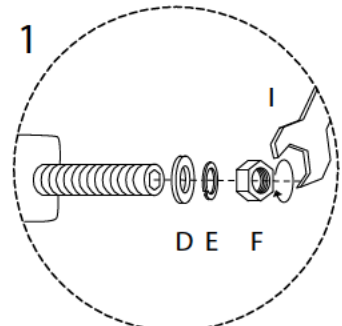
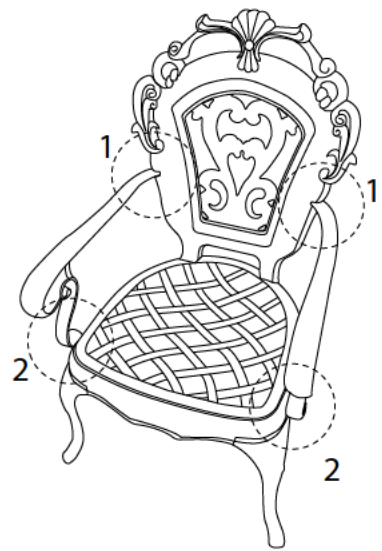
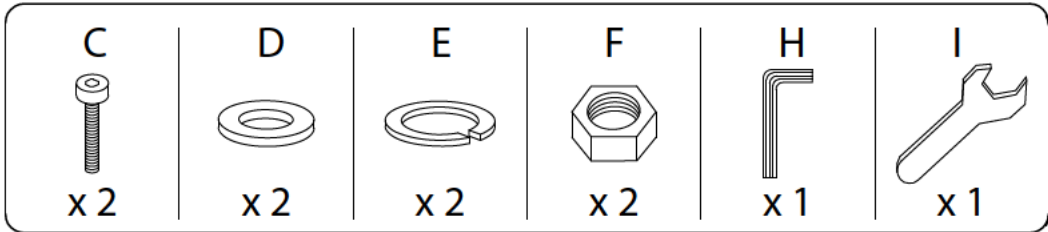

7

G

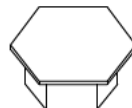

x 10

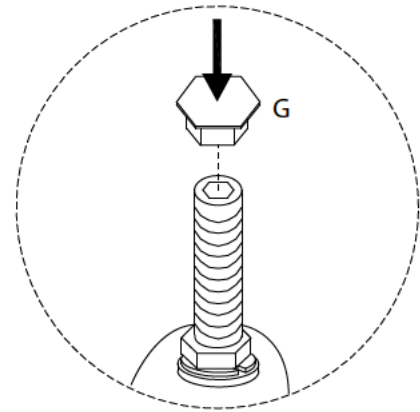
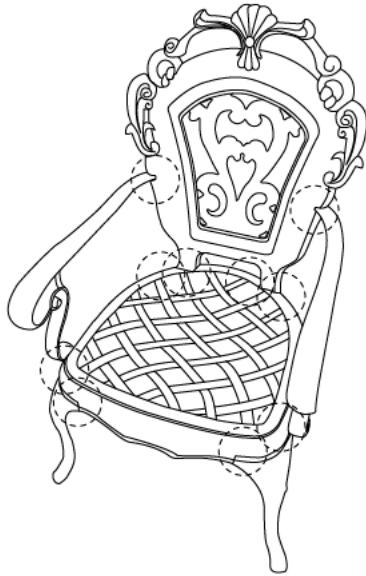

8

7



x 1

