

# ASSEMBLY INSTRUCTION

N723P379656 N723P379657  
N723P379658 N723P379659

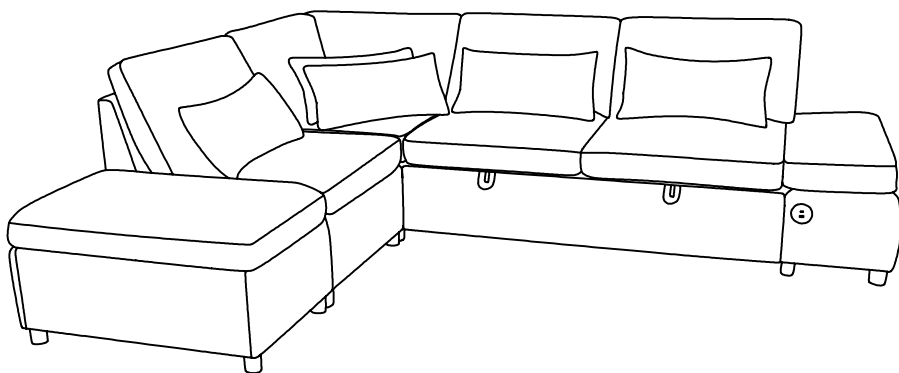

**Sets often ship in multiple boxes and delivery date may vary.**

## CUSTOMER SERVICE

**Questions, Missing parts, Assembly help?  
No need to return the product, we will gladly help and ship**

# PRE-ASSEMBLY INFORMATION

**Please read this manual carefully before beginning assembly of this product. Keep this manual for future reference.**

## NOTICE

1. Please assemble it AFTER all boxes are received.
2. Please do not throw away any of the packages or the instruction until the sofa is fully assembled.
3. Please keep children away from the plastic bags or any small pieces of stuff.
4. Some key parts of our product may be stored and hidden inside of other parts. Please open any zippered or hook & loop storage compartments to take out all parts.
5. Please do not open the compressed packages until your sofa frame is completely assembled.
6. As the cushions are all vacuum compressed, there will be some wrinkles. Please give them up to 72 hours to reach its original size and the wrinkles will basically disappear.
7. DO NOT INSTALL THE SCREWS ALL THE WAY IN THE BEGINNING. Place each screw into their proper hole and use your hand to twist the screw halfway. Twist all the screws in halfway to ensure the holes will match up properly and the product is level on the ground. When everything seems fitted, then tighten the screws.
8. Do not over tighten screws and bolts to avoid stripping.



**2 adults recommended**



**Takes about 1.5 Hours to assemble**









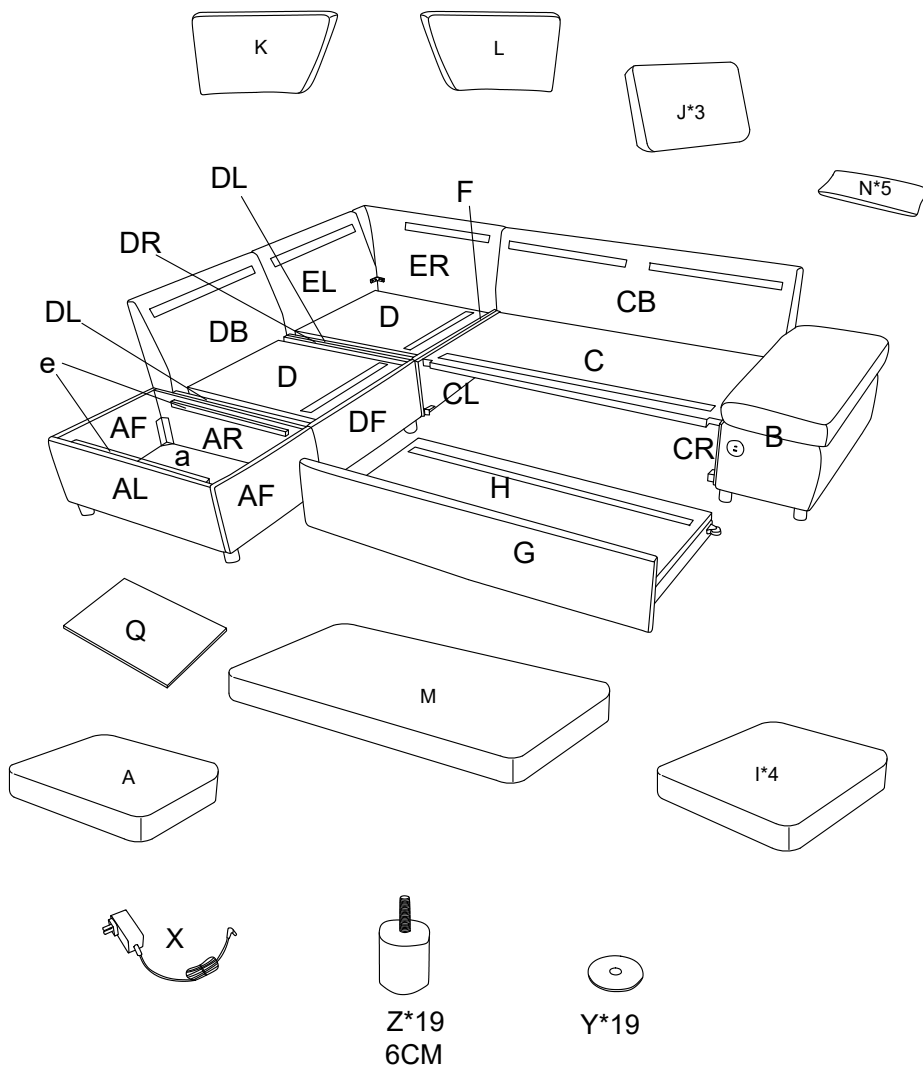





**Weight capacity of each seat: 330LBS**

---

# COMPONENTS



# COMPONENTS

HARDWARE			
NO	DESCRIPTION	SKETCH	QTY
①	Leg irons		7
②	Hinges		7
③	Metal brackets		5
④	Left wheel retainer		1
⑤	Right wheel retainer		1
⑥	Wheels		6
⑦	Screws M6*15MM		76
⑧	Screws M6*30MM		13
⑨	Screws M6*40MM		16
⑩	Screws M6*55MM		10
⑪	Screws M5*15MM		24
⑫	Nuts M6		6
⑬	Wrench		1

# COMPONENTS

N723P379656

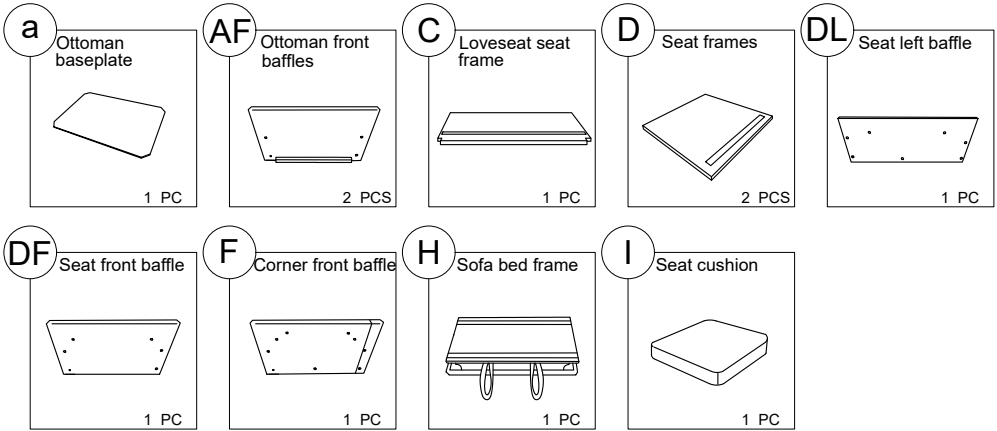

N723P379657

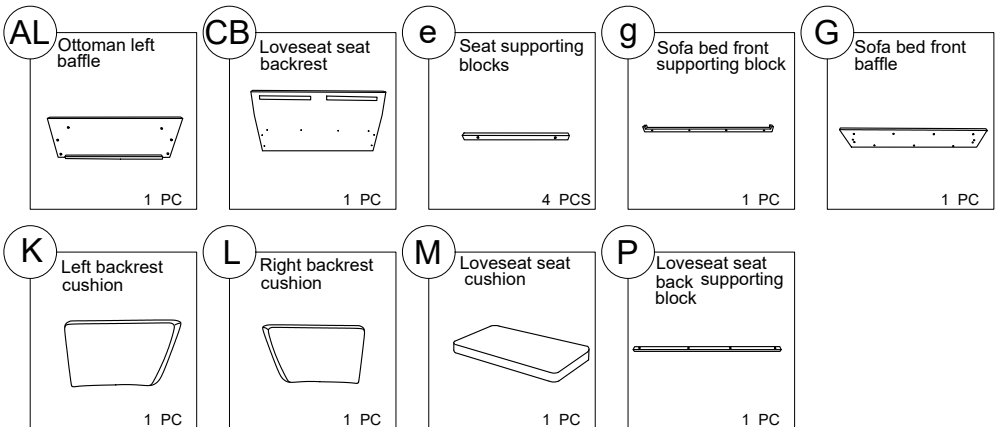

# COMPONENTS

**N723P379658**

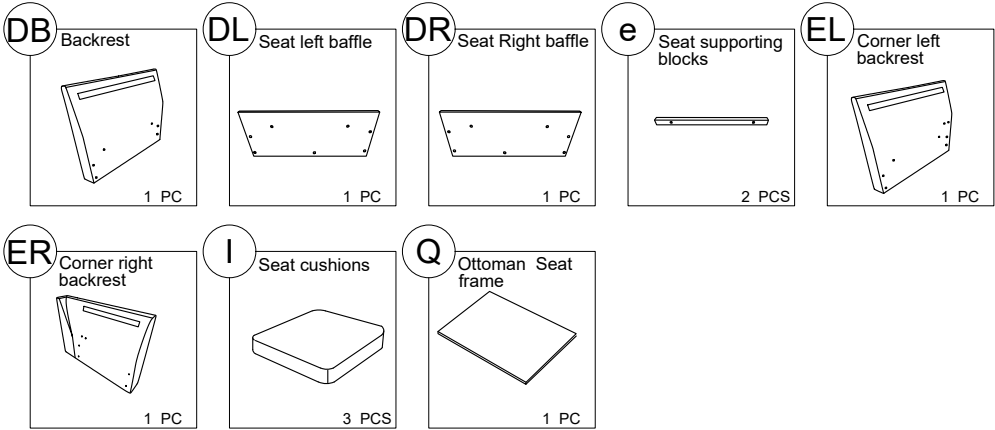

**N723P379659**

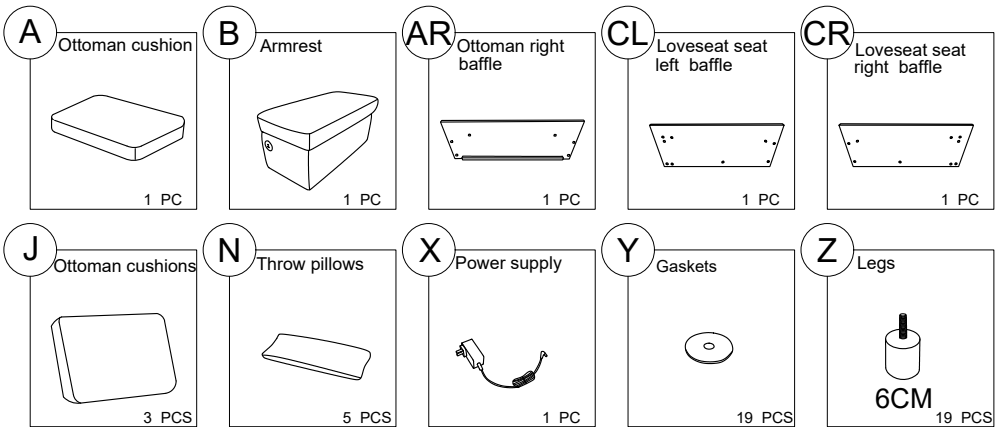

Hardware  
+  
Manual

**STEP 1** Take out all the parts stored or hidden inside

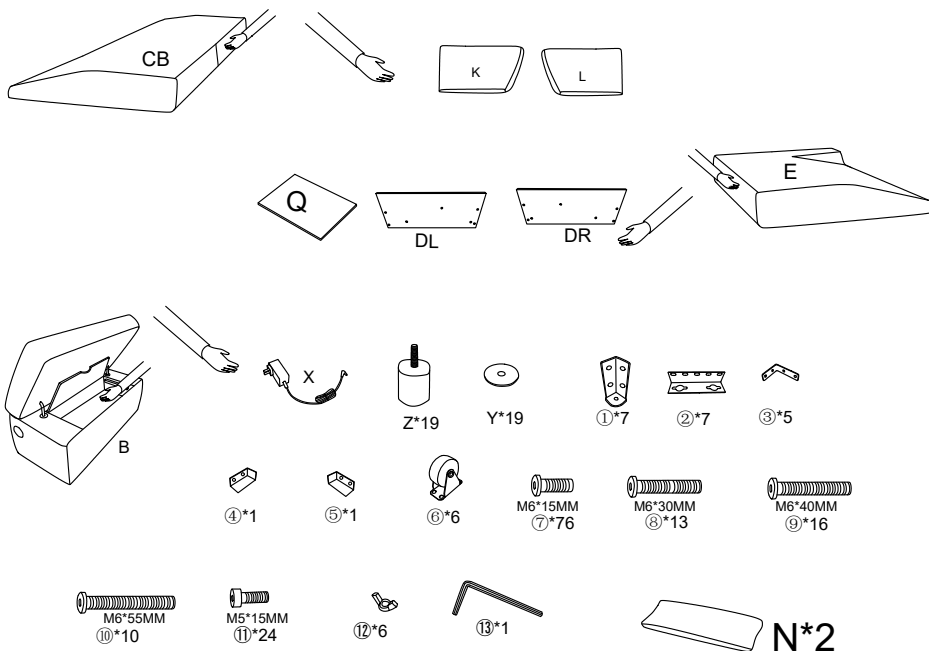

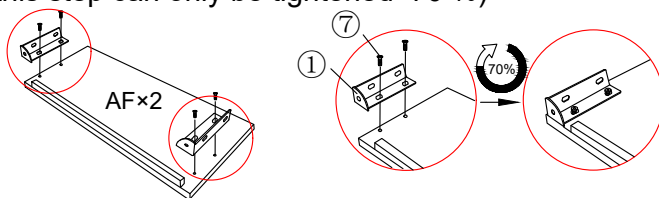
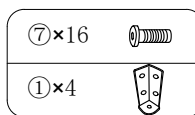

**STEP 2** Use screws 6\*15mm (7) to link leg irons (1) to ottoman front baffles (AF), then tighten the screws with a wrench (13). (Note that the screws in this step can only be tightened 70%)

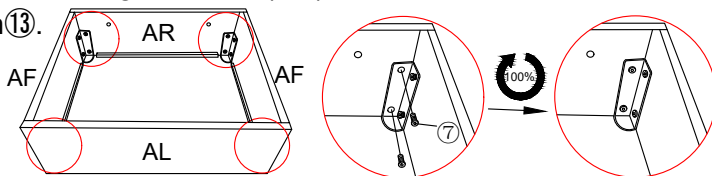

Use screws 6\*15mm (7) to link leg irons (1) to ottoman right baffle (AR) and ottoman left baffle (AL), then tighten the screws on the ottoman front baffles (AF) and ottoman right baffle (AR) and ottoman left baffle (AL) with a wrench (13).



**STEP 3** Use screws 6\*15mm (7) to link leg irons (1) and Hinges (2) to Seat left baffles (DL) and Seat right baffle (DR), then tighten the screws with a wrench (13). (Note that the screws in this step can only be tightened 70 %)

(7)×12	
(2)×3	
(1)×3	

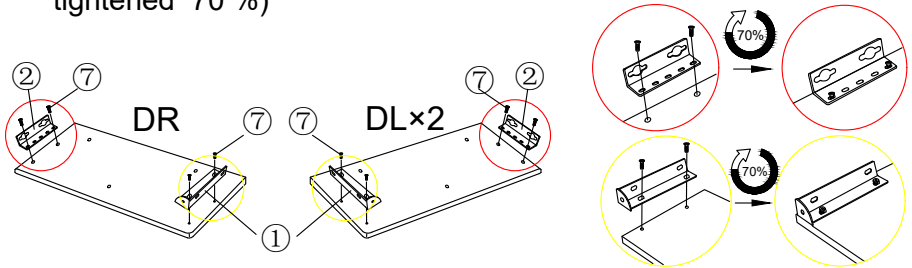

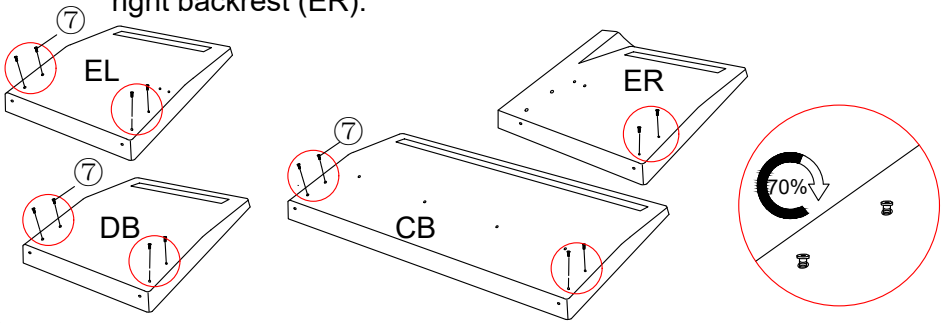

**STEP 4** Please tighten the screws 6\*15mm (7) screw to about 70% on the backrest (DB), loveseat seat backrest (CB), corner left backrest (EL) and corner right backrest (ER).

(7)×14	
--------	---



**STEP 5** Use screws 6\*15mm (7) to link the hinge (2) to Corner right backrest (ER), then tighten the screws with a wrench (13). (Note that the screws in this step can only be tightened 70 %)

(7)×2	
(2)×1	

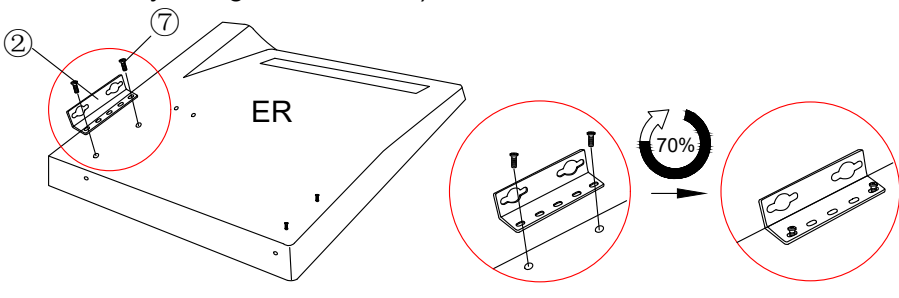

**STEP 6** Use screws 6\*15mm (7) to link Hinge (2) to corner front baffle (F), then tighten the screws with a wrench (13). (Note that the screws in this step can only be tightened 70 %)

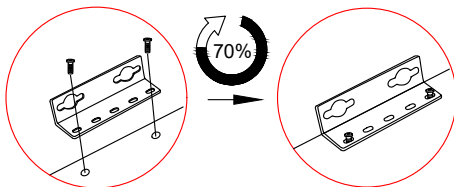
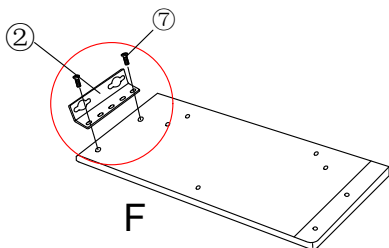
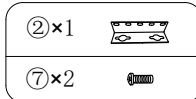

**STEP 7** Use screws 6\*15mm (7) to link legs irons (1) to Seatfront baffle (DF), then tighten the screws with a wrench (13). Hang seat left baffle (DL) and seat right baffle (DR) on the screws of backrest (DB), then tighten the screws on the backrest by a wrench (13).

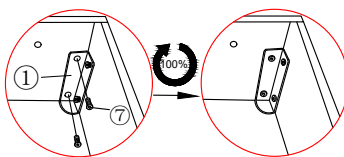
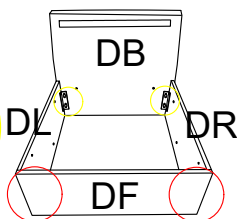
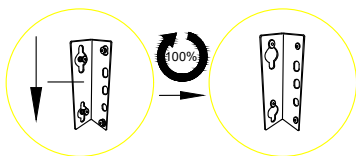
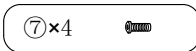

Use metal screws 6\*15mm (7) to link legs irons (1) to corner front baffle (F), then tighten the screws with a wrench (13). Hang seat left baffles (DL) and corner right backrest (ER) on the screws of corner left backrest (EL), hang corner front baffle (F) on the screws of corner right backrest (ER), then tighten the screws on the backrest by a wrench (13).

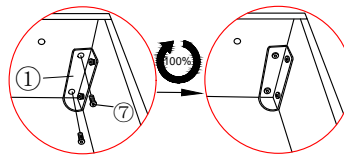
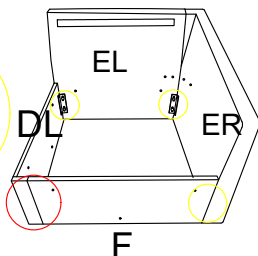
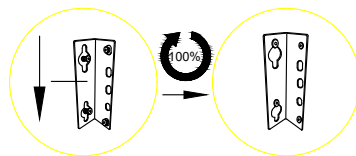
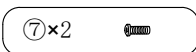

**STEP 8** Use screws 6\*15mm (7) to link metal bracket (3) to corner left backrest (EL) and corner right backrest (ER), then tighten the screws with a wrench (13). Place ottoman baseplate (a) on the bottom of the ottoman seat frame.

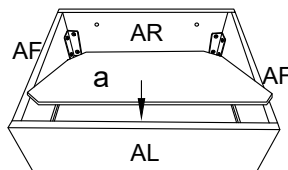
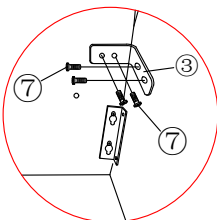
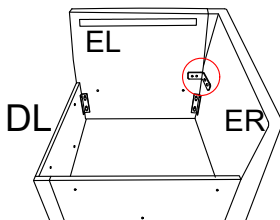
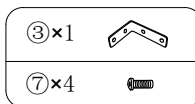

**STEP 9** Use Screws 6\*40mm (9) to link seat supporting blocks (e) to seat front baffle (DF) / backrest (DB) / corner left backrest (EL) / corner front baffle (F) / ottoman right baffle (AR) / ottoman left baffle (AL). Tighten the screws with a wrench (13).

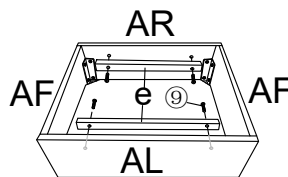
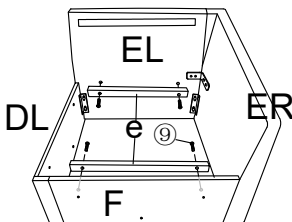
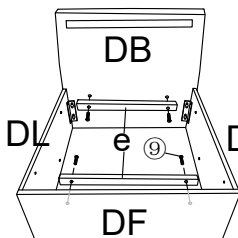
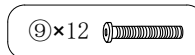

**STEP 10** Use screws 6\*15mm (7) to link hinges (2) and metal brackets (3) and left wheel retainer (4) and right wheel retainer (5) to loveseat seat left baffle (CL) and loveseat seat right baffle (CR), then tighten the screws with a wrench (13). (Note that the screws in this step can only be tightened 70%)

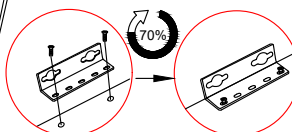
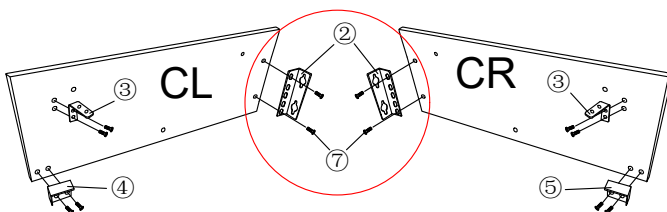
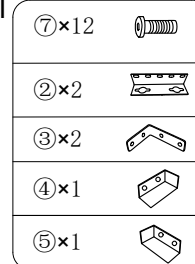

**STEP 11** Hang loveseat seat left baffle(CL) and loveseat seat right baffle(CR) on the screws of loveseat seat backrest(CB), Use screws 6\*40mm ⑨ to link loveseat seat back supporting block (P) to loveseat seat backrest(CB), then tighten the screws on the backrests by a wrench ⑬.

⑨×4 

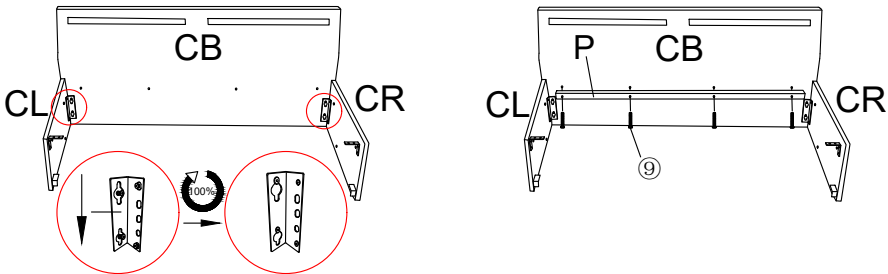

**STEP 12** Use screws 6\*30mm ⑧ to fix metal brackets ③ on loveseat seat frame(C) by wrench ⑬.

⑧×4 

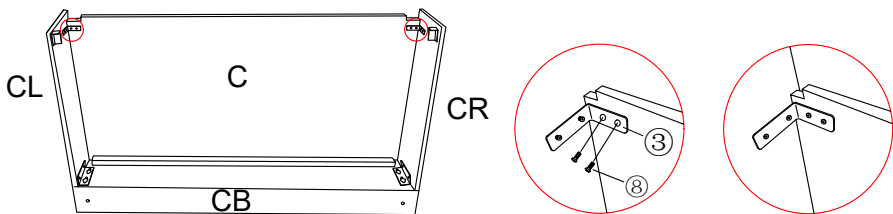

**STEP 13** Attach legs (Z) and gaskets (Y) to the seat frames, backrests and armrest.

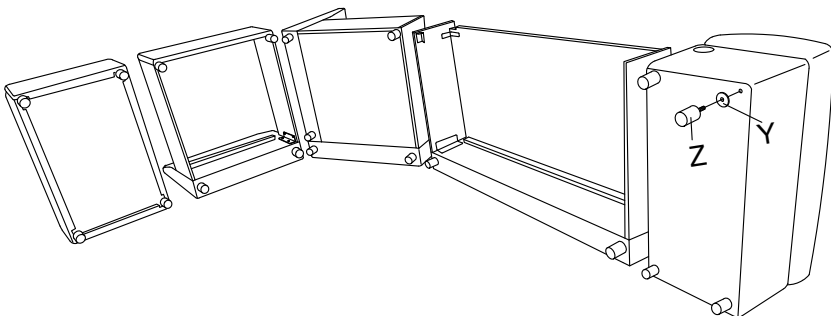

**STEP 14**

Install loveseat seat left baffle(CL) on corner front baffle(F) with screws 6\*55mm(10) and nuts M6(12) by wrench(13). Place nuts M6(12) on the(F) side.  
 Install loveseat seat right baffle(CR) on armrest (B) with screws 6\*30mm(8) by wrench(13).

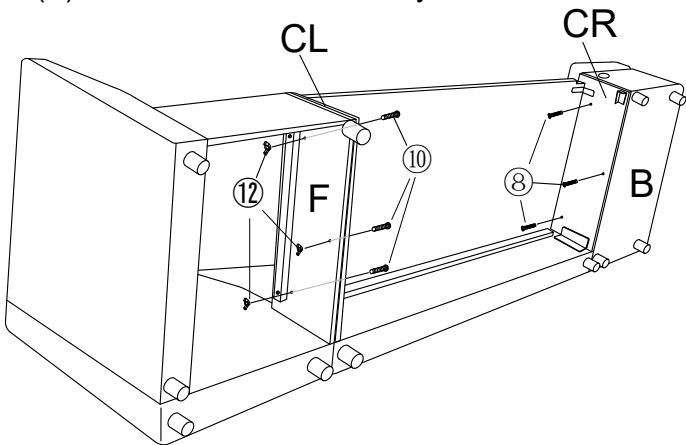
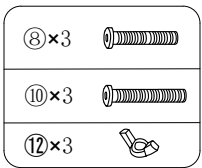
**STEP 15**

Use nuts M6 (12), screws 6\*55mm(10) to link the seat frames by wrench (13)

Use screws 6\*30mm (8) to link the seat frame and ottoman seat frame by wrench (13).

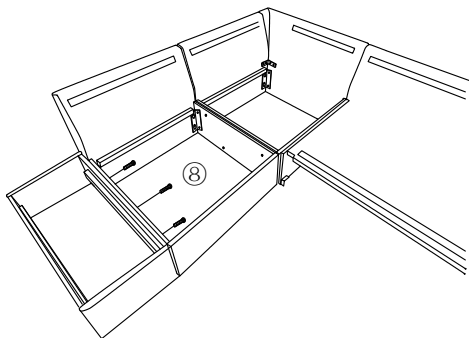
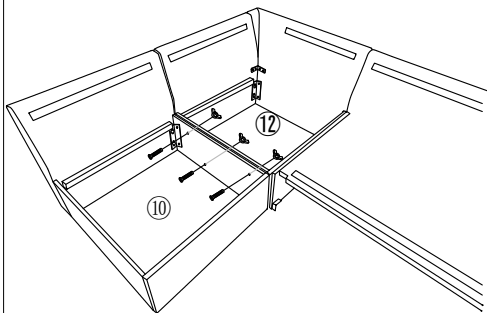
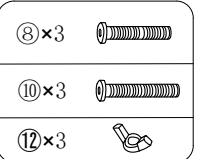

**STEP 16** Use screws 5\*15mm (11) to link wheels (6) to sofa bed frame (H), then tighten the screws with a wrench (13).

(11) × 24 

(6) × 6 

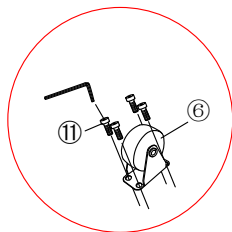
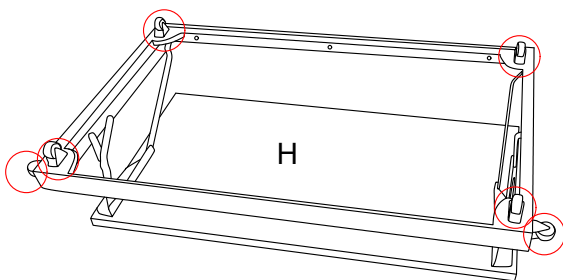

**STEP 17** Use screws 6\*15mm (7) to fix metal brackets (3) on sofa bed front baffle (G) by wrench (13). (Note that the screws in this step can only be tightened 70%)

(7) × 4 

(3) × 2 

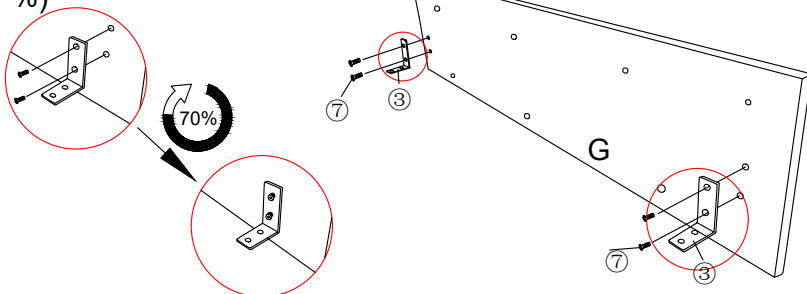

**STEP 18** Use screws 6\*30mm (8) to link sofa bed frame (H) to sofa bed front baffle (G) by wrench (13).

(8) × 3 

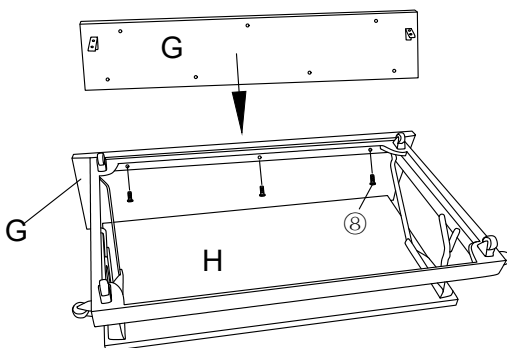

**STEP 19** Use screws 6\*15mm (7) to link metal brackets (3) to sofa bed frame (H), then tighten the screws with a wrench (13).  
Use screws 6\*55mm (10) to link sofa bed front supporting block (g) to sofa bed front baffle (G) by wrench (13).

(10)×4 

(7)×4 

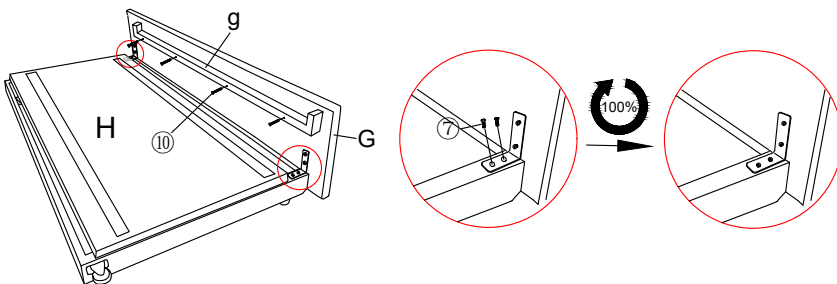

**STEP 20** Insert sofa bed frame into loveseat frame. Install wheels (6) into left and right wheel retainers (4 and 5).

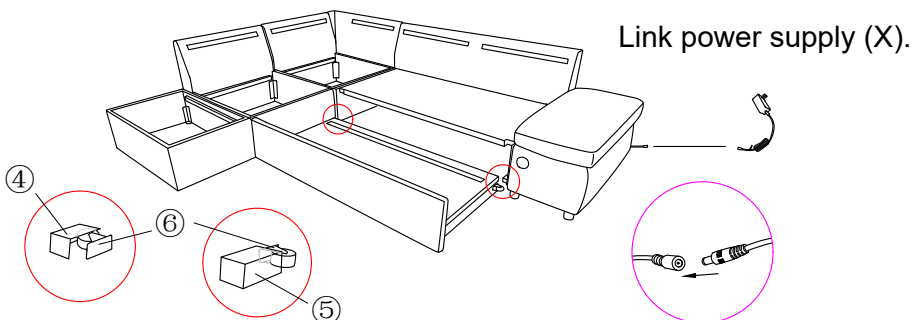

**STEP 21** Place seat frames (D) on the top of the seat frames. Place ottoman seat frames (Q) on the top of the ottoman seat frames.

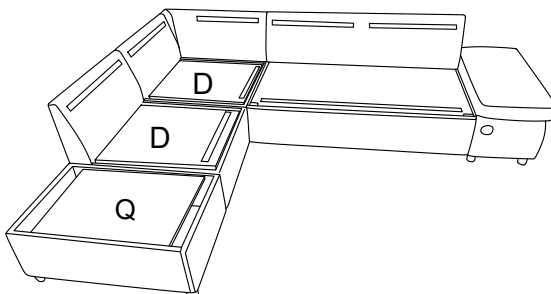

**STEP 22** Open the vacuum bag and take the throw pillows/backrest cushions(N/J/K/L), Seat cushions/ottoman cushion(I/M) out. To restore the original shape, follow the steps below.

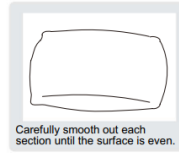
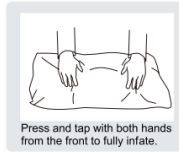

After packing up, place them in somewhere dry and ventilated. After about 72-96 hours. It can be restored to the best use condition.

**STEP 23** Put the cushions and pillows and seat cushions on the sofa.

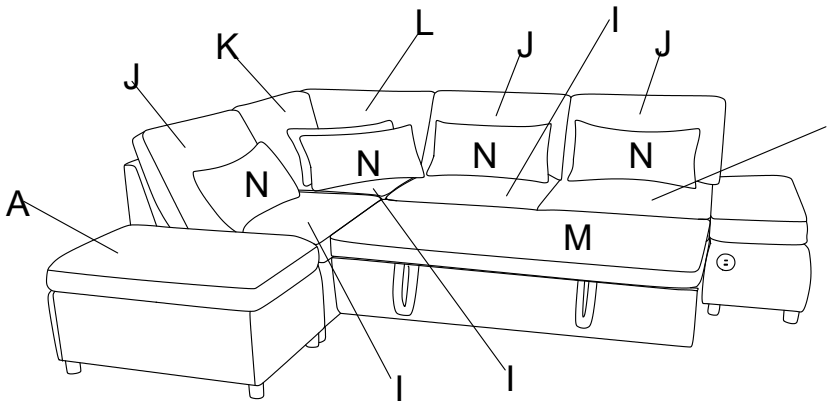

**STEP 24** Complete

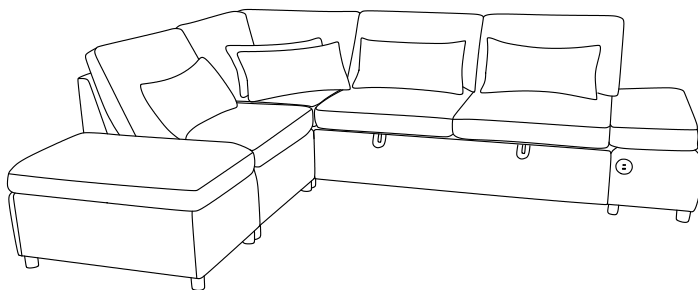

or

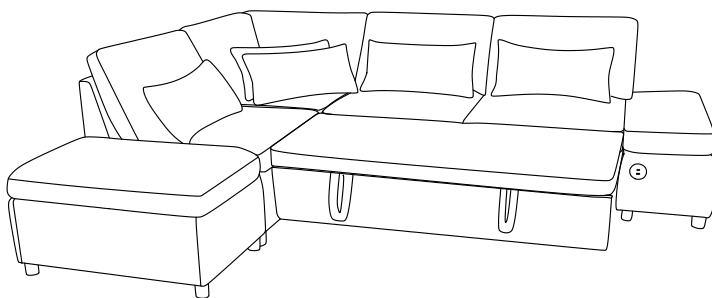

or

