

CONSOLE TABLE

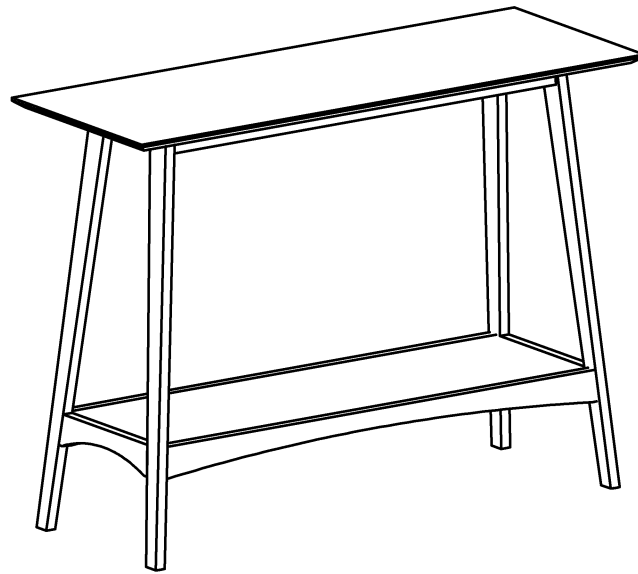





Assembly Instruction

We have designed our furniture with you, the customer in mind. Our clear, easy to follow step by step instructions will guide you through the project from start to finish. Feel confident that this will be a fun and rewarding project. The final product will be a quality piece of furniture that will go together smoothly and give years of enjoyment.

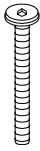
Please verify all parts are present before beginning assembly

Hardware List

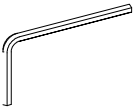
 <p>A</p>	 <p>B</p>	 <p>C</p>	 <p>D</p>
Allen Bolt (8 pcs)	Spring Washer (8 pcs)	Flat Washer (8 pcs)	Wooden Dowel (4 pcs)
 <p>E</p>			
Allen wrench (1 pc)			

Parts List

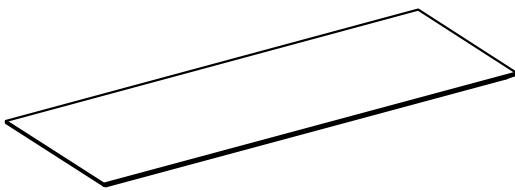

(1) - Table Top (1pc)

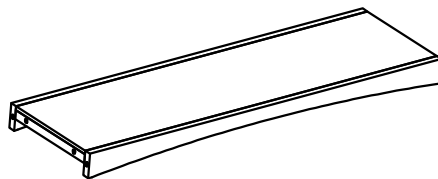

(2) - Shelf (1pc)

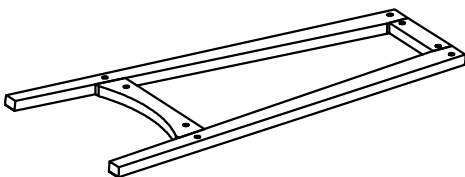

(3) - Leg Frame (2pcs)

Assemble unit on carpet or other soft surface

Step 1

1. Insert Wooden Dowel (D) into Table Top (1) as shown
2. Turn Table Top (1) on its side and Connect Legs Frame (3) to Table Top (1) using Allen bolt (A), Spring Washer (B), Flat Washer (C) and Allen Wrench (E).
3. Insert Wooden Dowel (D) into Shelf (2) and connect to Leg Frame (3) using Allen bolt (A), Spring Washer (B), Flat Washer (C) and Allen Wrench (E).

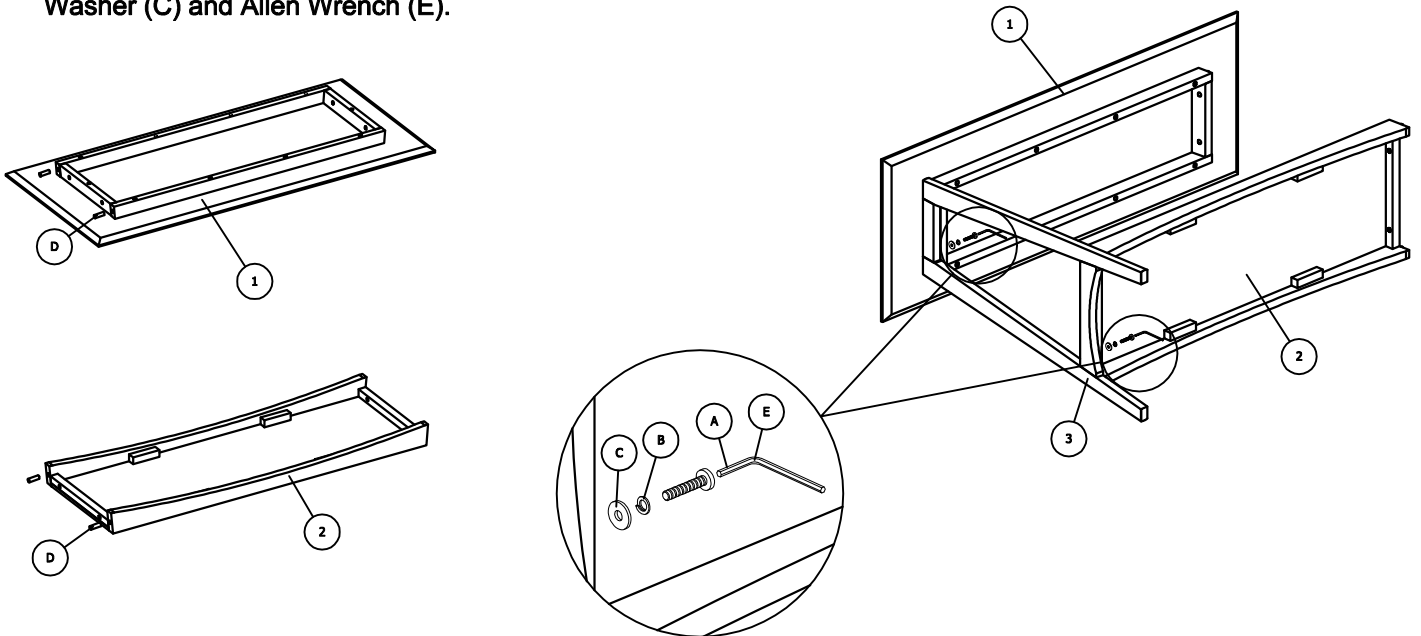

* Do not fully tighten Allen Bolts at this time *

Step 2

1. Insert Wooden Dowel (D) into second Leg Frame (3)
2. Connect second Leg Frame (3) to unit using Allen bolt (A), Spring Washer (B), Flat Washer (C) and Allen Wrench (E)
3. Fully tighten all Allen Bolts.
4. Enjoy.

