

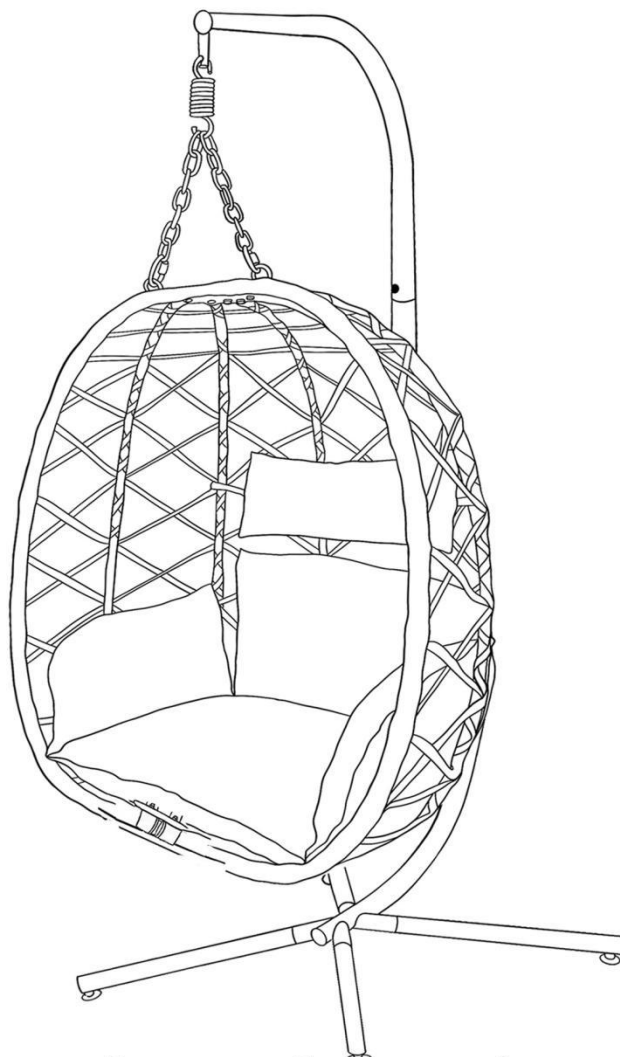







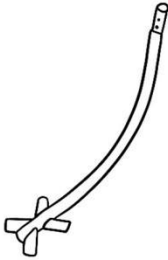

# Egg Swing Chair

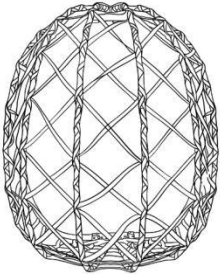
## Installation Instructions

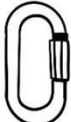

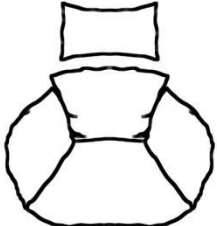
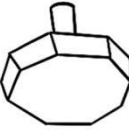
**Online Support: [kannel\\_service@outlook.com](mailto:kannel_service@outlook.com)**

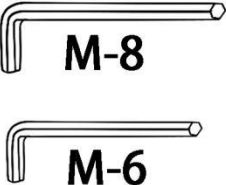
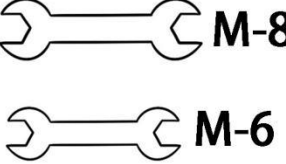
Feel free to contact Installation Instructor Team!

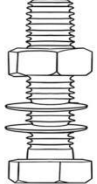
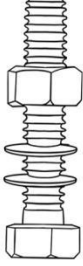
			
A   1	B   1	C   4	D   1
			
E   1	F   1	G   2	H   2
	 reinforcement		 M-8 M-6
I   1	J   4	M-8,60mm   1	Hexwrench
 M-8 M-6	 height adjuster		
Wrench	N   4	M-8,20mm   12	M-6,40mm   4

## Step 1:

Screw the 4 height adjusters (N)  
into the ends of the 4 support legs (C)

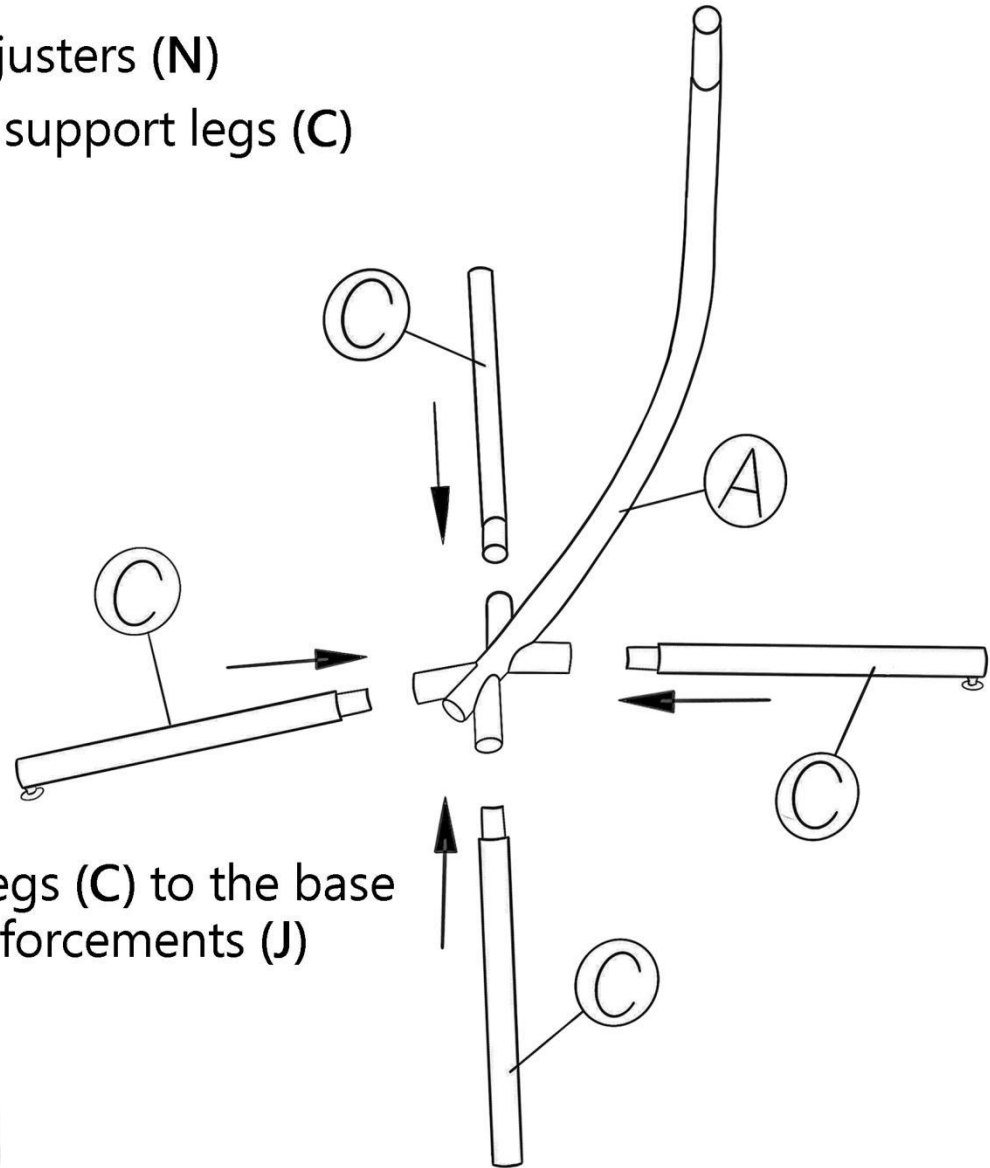
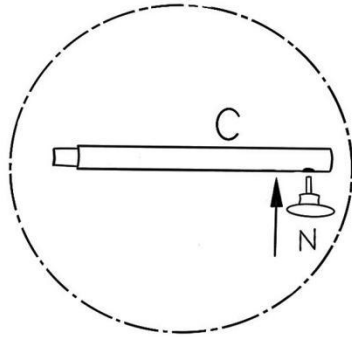

## Step 2:

Fasten the 4 support legs (C) to the base  
frame (A) with the reinforcements (J)

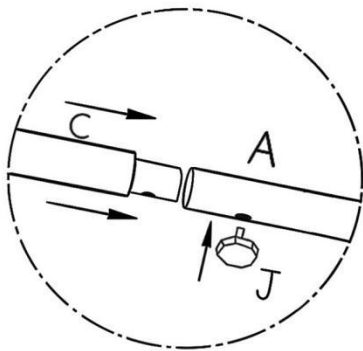

### Step 3:

Attach accessories (A) and (B) together using screw-M-8,60mm

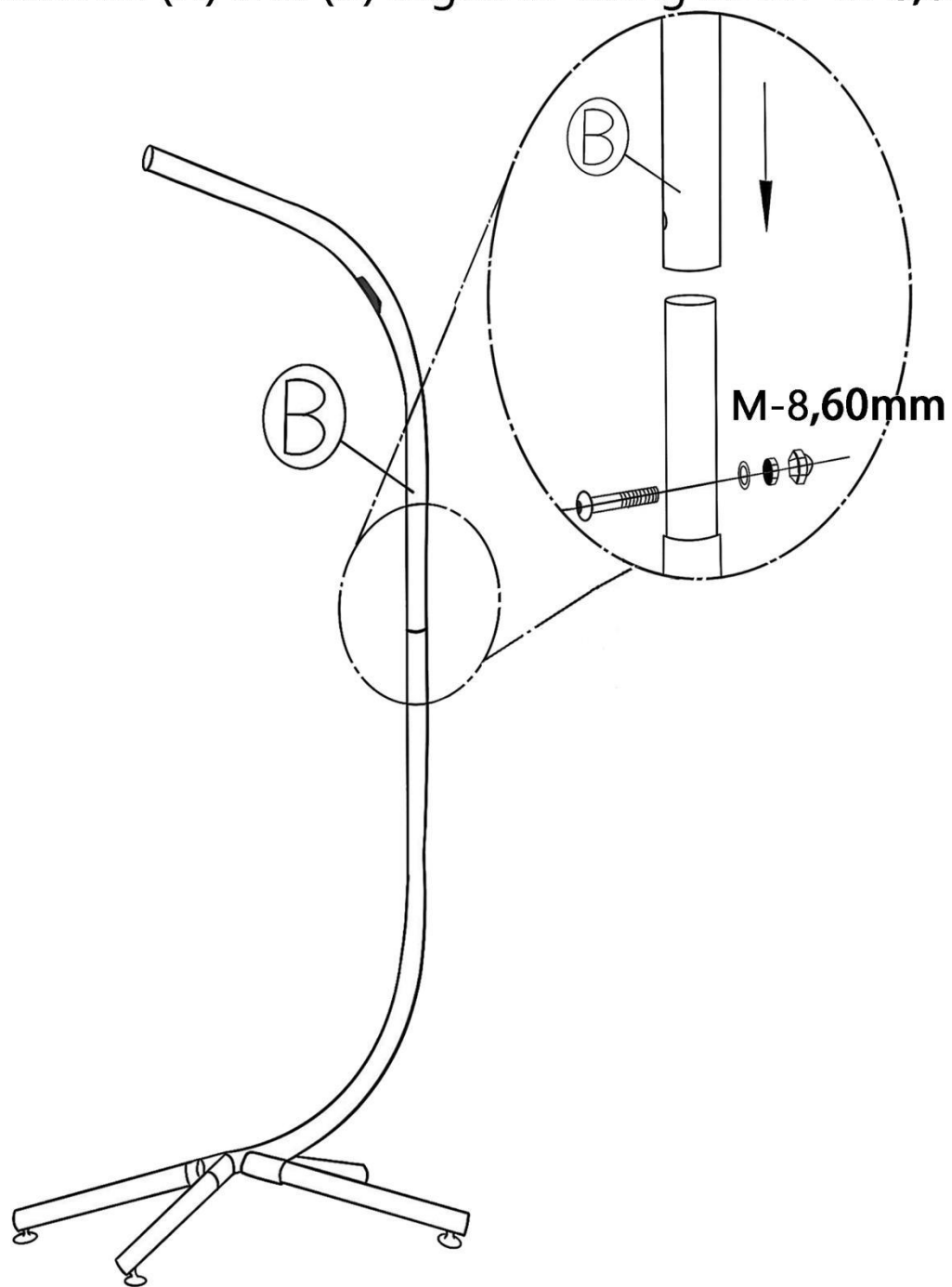

## Step:4

Simply flip the chair base (D) over.

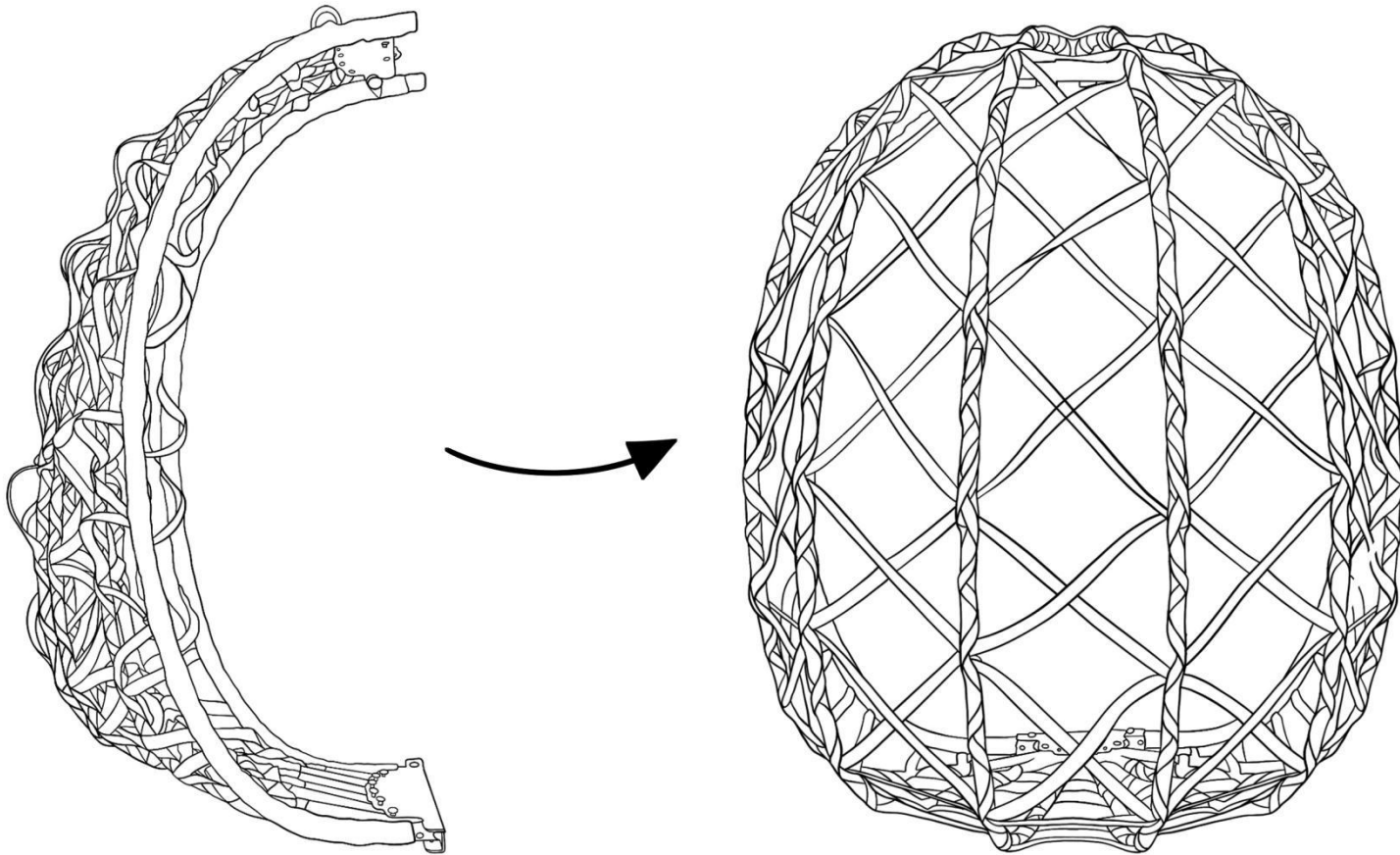

## Step:5

Assemble the seat of the chair as shown

--6 (M-8,20mm), 2 (M-6,40mm)

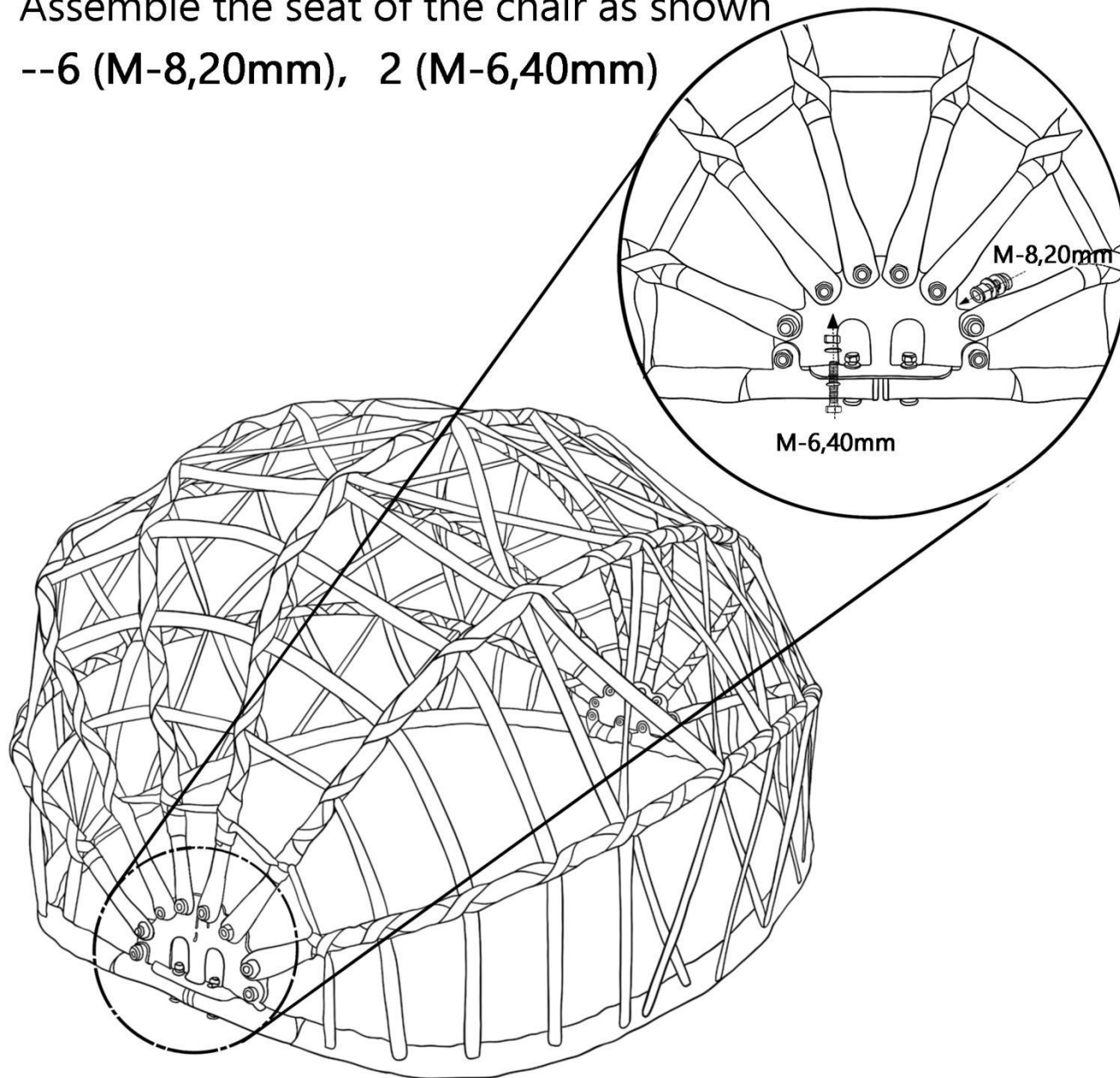

**Installation advice:** Install the base by placing it on the floor

## Step:6

Installation of 6 (M-8,20mm), 2 (M-6,40mm)

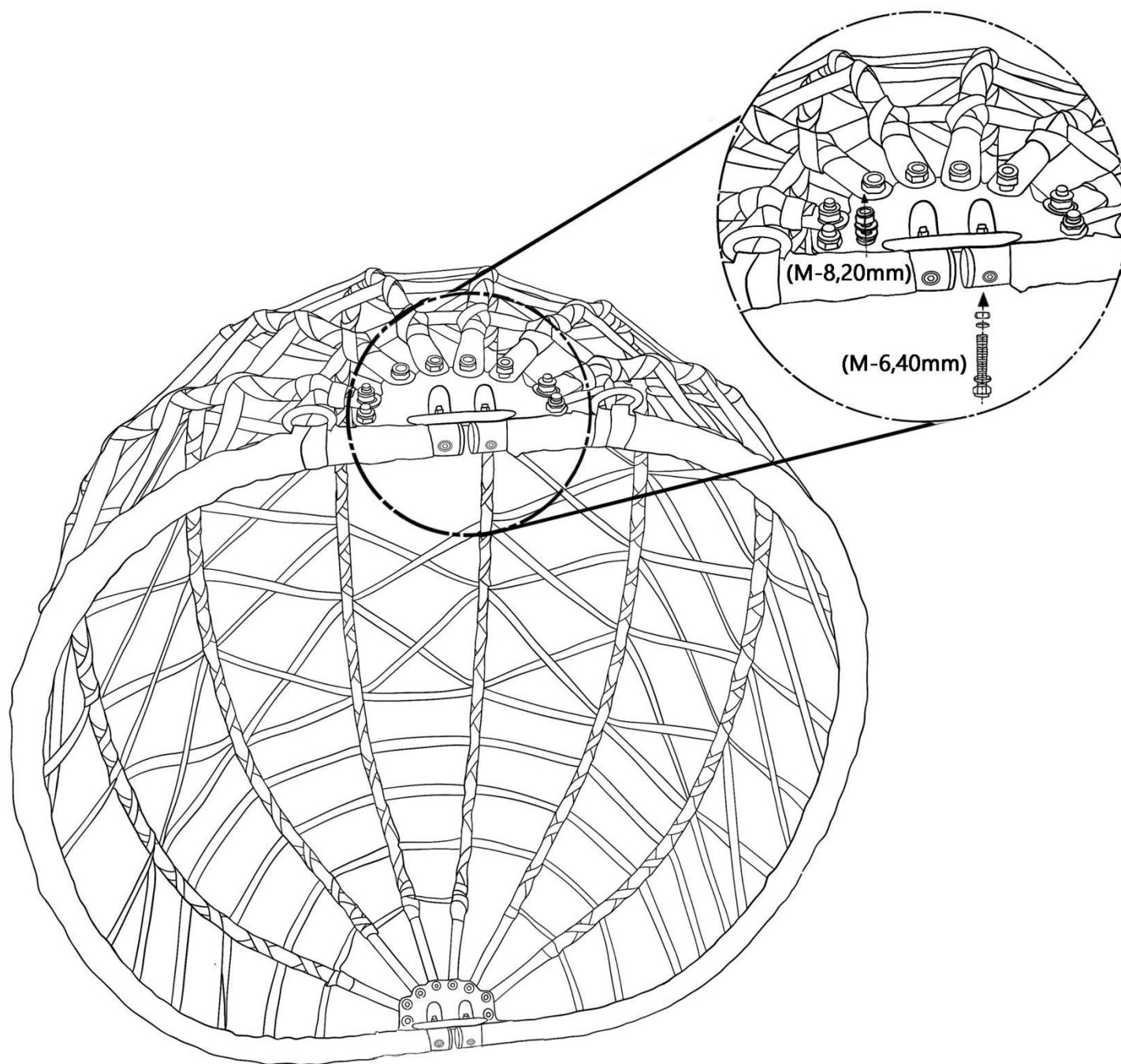

Step:7

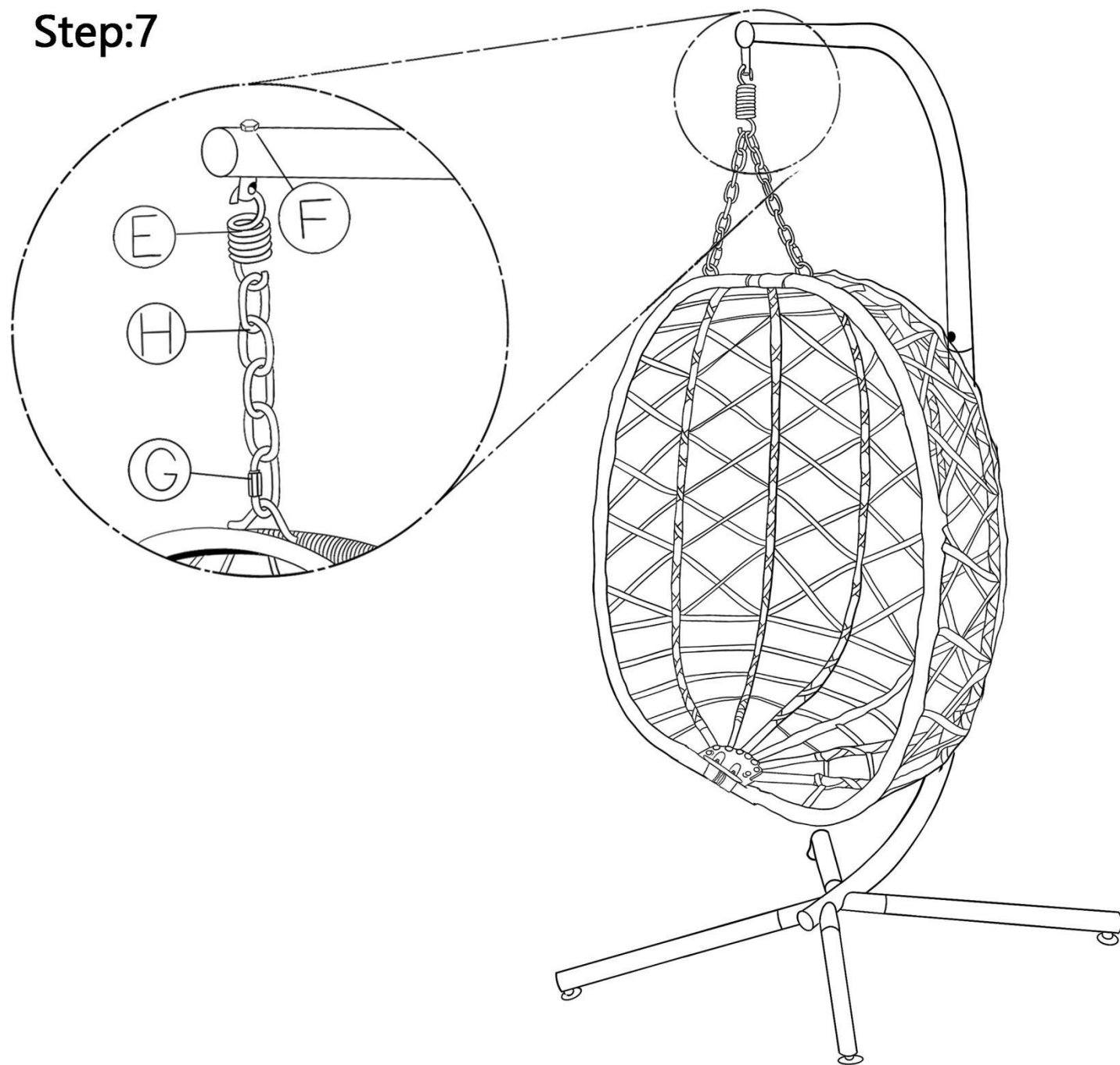

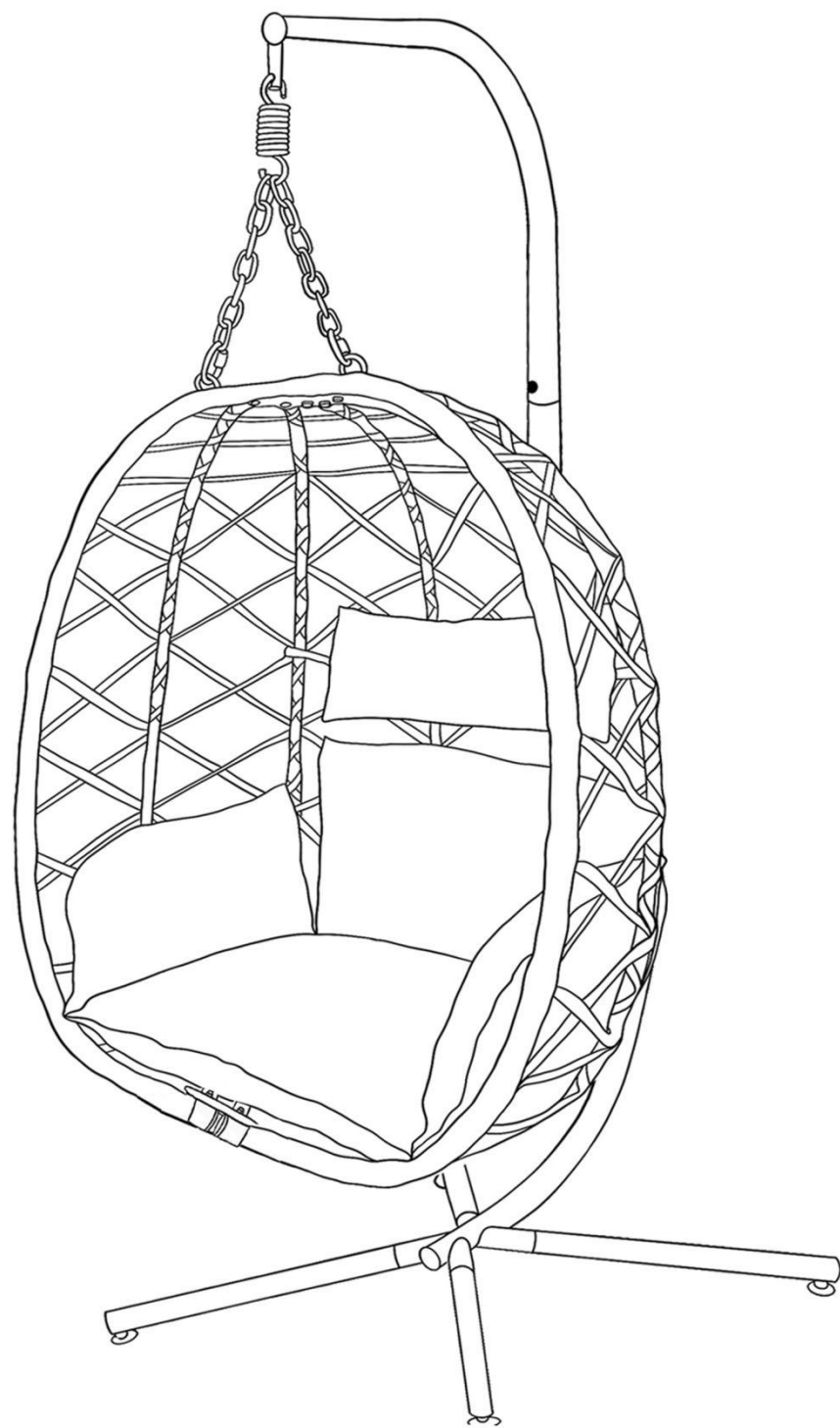

# ONLINE SUPPORT

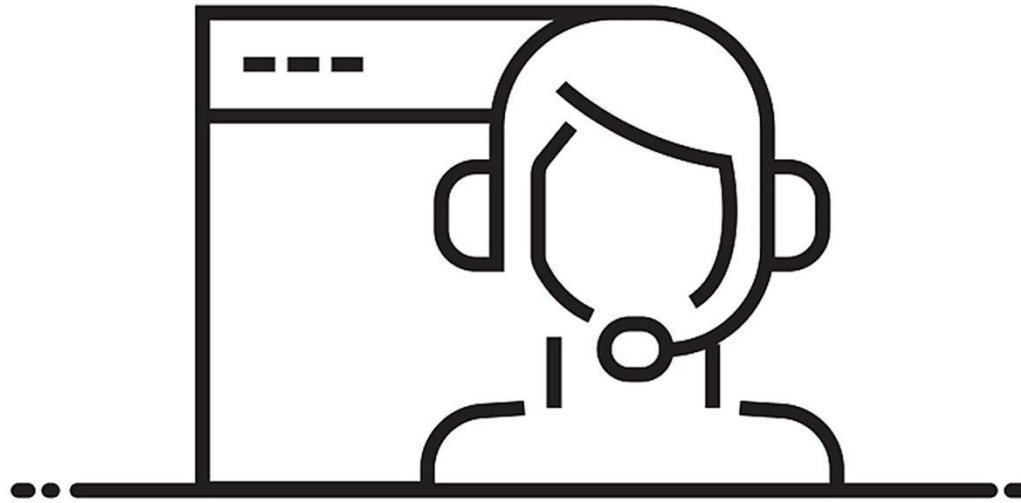

Please read the installation guide carefully before installation  
If you have any questions during the installation process  
you can contact us and we will provide you a detailed guidance

**Online Support: [kannel\\_service@outlook.com](mailto:kannel_service@outlook.com)**