

ASSEMBLY INSTRUCTIONS

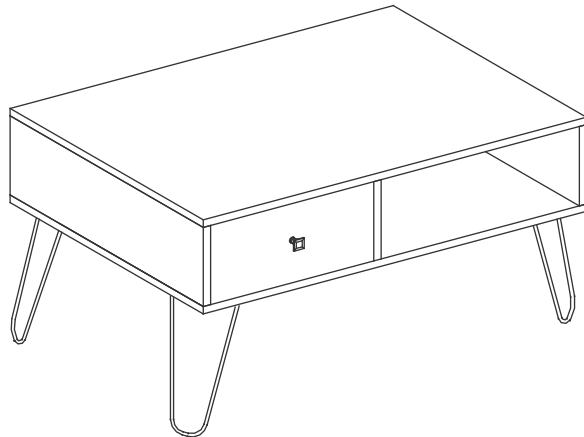

IMPORTANT

PLEASE READ BEFORE YOU CONTINUE FURTHER

PLEASE KEEP THE ORIGINAL PACKAGING UNTIL THE ITEM IS FULLY ASSEMBLED AND IN PLACE . IN THE UNLIKELY EVENT THAT YOU NEED TO RETURN YOUR PRODUCT, IT MUST BE RETURNED IN ITS ORIGINAL PACKAGING TO AVOID FURTHER DAMAGE . FAILURE TO COMPLY TO THESE PROCEDURES, NO RETURN'S WILL BE ACCEPTED .

THE PRODUCT YOU HAVE PURCHASED WILL GIVE YOU MANY YEARS OF SERVICE IF YOU FOLLOW THE GUIDELINES FOR ITS SAFE ASSEMBLY AND PERIODIC MAINTENANCE AND CLEANING .

ASSEMBLE ON A SOFT CLEAN SURFACE .

DO NOT USE ANY TOOLS OTHER THAN THOSE SHOWN .

ANY SPANNERS OR ALLEN KEYS REQUIRED ARE INCLUDED WITH FITTINGS KIT. DO NOT FOR ANY REASON USE A POWER TOOL TO ASSEMBLE THIS PRODUCT. ITS USE WILL INVALIDATE ANY CLAIM YOU MAY HAVE AND COULD MAKE THIS PRODUCT UNSAFE .

DEPENDING ON THE AMOUNT OF USE THIS PRODUCT RECEIVES IT MAY BE NECESSARY TO TIGHTEN UP THE FIXINGS FROM TIME TO TIME.THIS IS COMPLETELY NORMAL FOR ANY FLAT PACK FURNITURE .
DO NOT OVERTIGHTEN FIXINGS.

FOR CLEANING , YOU MAY USE A DAMP CLOTH (NOT WET) . THE SURFACE TO THIS ITEM IS NOT HEAT RESISTANT . ALWAYS USE A PLACE MAT UNDER HOT OR COLD ITEMS TO PREVENT MARKING .

PLEASE DO NOT THROW AWAY ANY PACKAGING UNIT ALL COMPONENTS HAVE BEEN CHECKED. IF COMPONENTS ARE MISSING PLEASE CONTACT SUPPLIER IMMEDIATELY .

TWO PERSONS REQUIRED TO ASSEMBLE THIS PRODUCT

1. Please check that you have all the parts listed before you start assembling. If you do find that something is missing .do not continue assembly . Please contact your supplier immediately.
2. Lay out all of the components on a soft surface as if you were preparing to do a jigsaw puzzle.
3. Separate and identify each component,from the hardware pack and rest each one in its proper location before fastening.

THE USE OF POWER TOOLS TO ASSEMBLE THIS PRODUCT WILL INVALIDATE ANY CLAIM AND ANY DAMAGE THIS PRODUCT MAKING IT UNSAFE

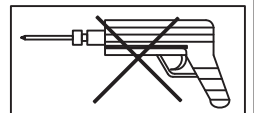



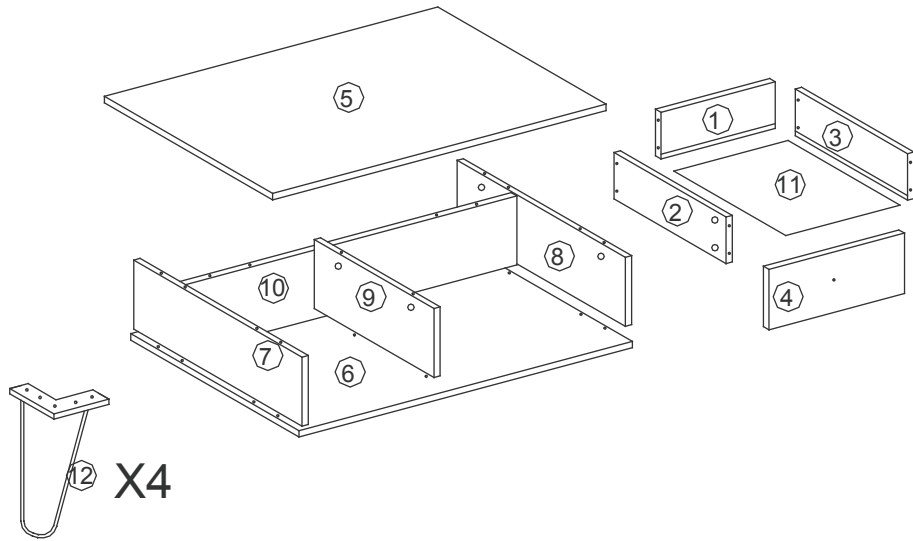





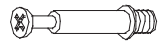

PARTS LIST

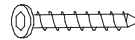

1	DRAWER BACK BOARD	1PC
2	DRAWER SIDE BOARD	1PC
3	DRAWER SIDE BOARD	1PC
4	DRAWER FRONT BOARD	1PC
5	TOP PANEL	1PC
6	BASE PANEL	1PC
7	LEFT SIDE PANEL	1PC
8	RIGHT SIDE PANEL	1PC
9	MIDDLE PANEL	1PC
10	BACK PANEL	1PC
11	DRAWER BOTTOM BOARD	1PC
12	METAL LEG	4PCS

HARDWARE LIST

P1		MALE CAMLOCK	12PCS
P2		FEMALE CAMLOCK	12PCS
P3	 M4X35mm	SCREW	4PCS
P4	 M8X30mm	DOWEL	12PCS
P5	 M3.5X12mm	SCREW	12PCS
P6	 CL DL DR CR	DRAWER RUNNER	1SET
P7	 M5X40mm	SCREW	8PCS
P8		HANDLE	1PC
P9	 M4X20mm	SCREW	1PC
P10	 M6X12mm	SCREW	20PCS
P11		HEXAGON KEY	1PC

THE USE OF POWER TOOLS TO ASSEMBLE THIS PRODUCT WILL INVALIDATE ANY CLAIM AND ANY DAMAGE THIS PRODUCT MAKING IT UNSAFE

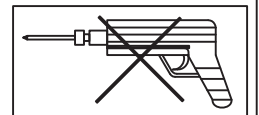

STEP 1

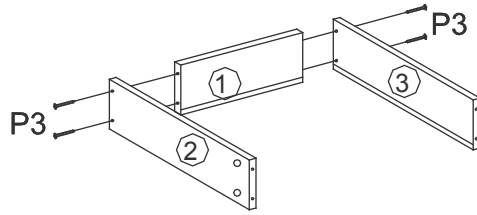

You will need:

P3	 M4X35mm	4PCS
----	---	------



STEP 2



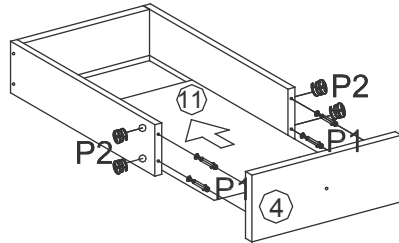

You will need:

P1		4PCS
P2		4PCS



STEP 3

You will need:

P9	 M4X20mm	1PC
P8		1PC
P5	 M3.5X12mm	6PCS
P6	 DL DR	1SET

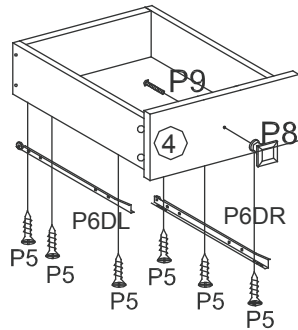

STEP 4

You will need:

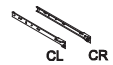
P5	 M3.5X12mm	6PCS
P6	 CL CR	1SET

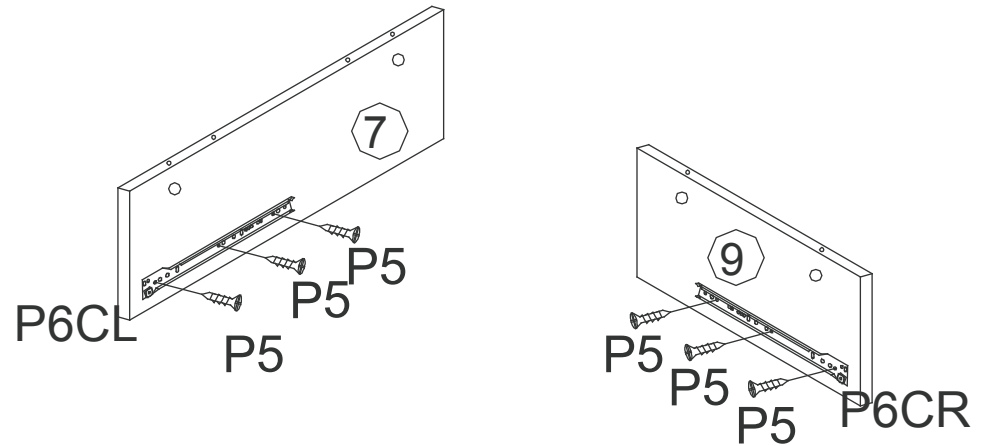

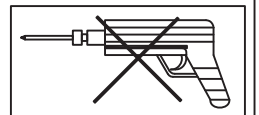

THE USE OF POWER TOOLS TO ASSEMBLE THIS PRODUCT WILL INVALIDATE ANY CLAIM AND ANY DAMAGE THIS PRODUCT MAKING IT UNSAFE



STEP 5

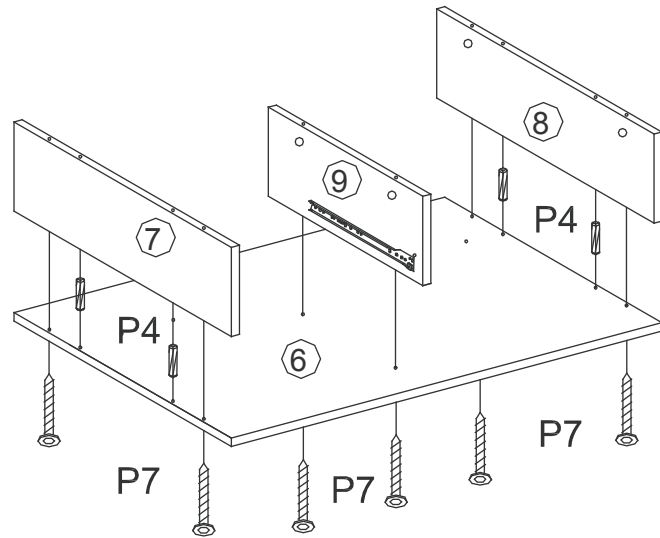

You will need:

P11		1PC
P7	 M5X40mm	6PCS
P4	 M8X30mm	4PCS



STEP 6

You will need:

P11		1PC
P7	 M5X40mm	2PCS
P4	 M8X30mm	2PCS

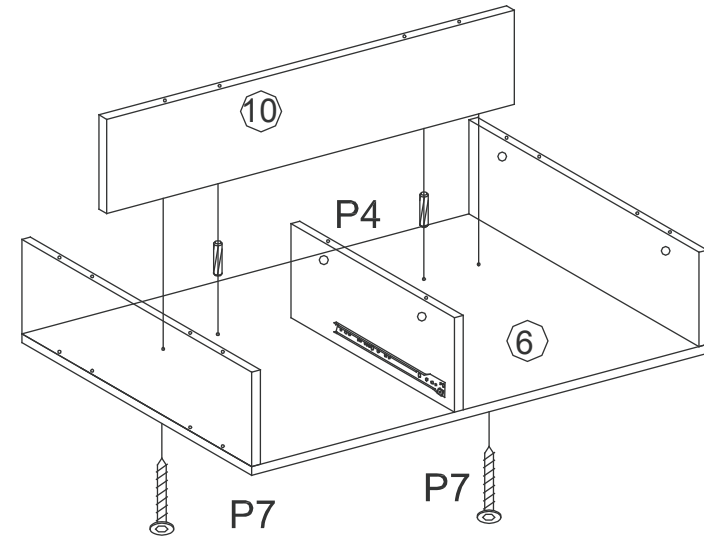

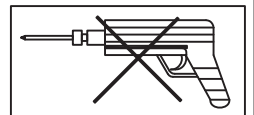

THE USE OF POWER TOOLS TO ASSEMBLE THIS PRODUCT WILL INVALIDATE ANY CLAIM AND ANY DAMAGE THIS PRODUCT MAKING IT UNSAFE



STEP 7

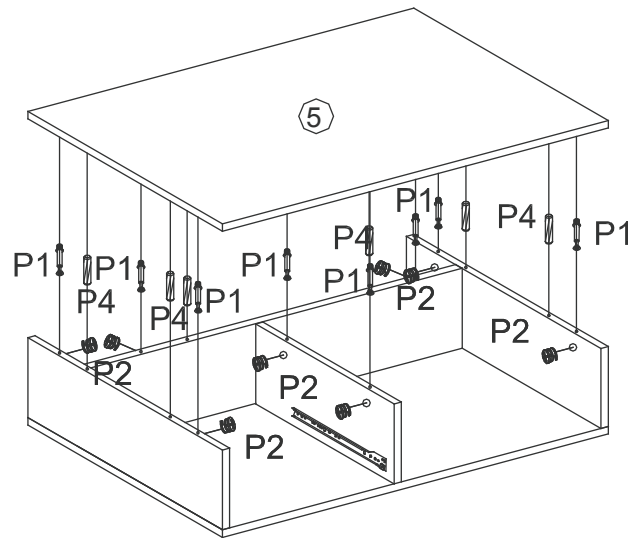

You will need:

P1		8PCS
P2		8PCS
P4		6PCS



STEP 8

You will need:

P11		1PC
P10		20PCS

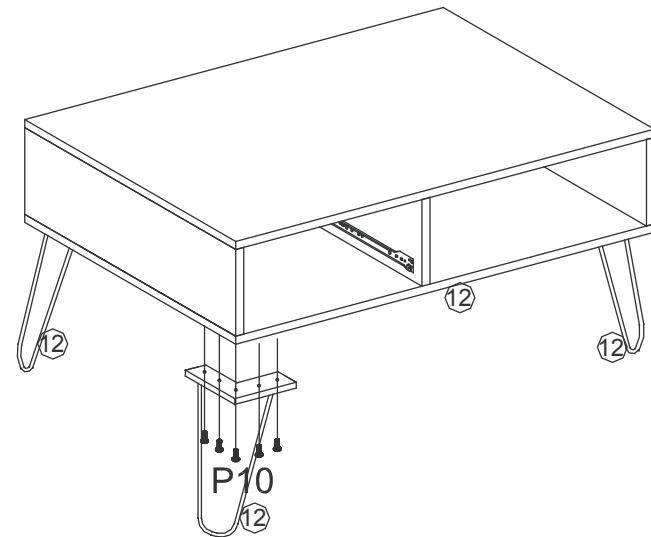

THE USE OF POWER TOOLS TO ASSEMBLE THIS PRODUCT WILL INVALIDATE ANY CLAIM AND ANY DAMAGE THIS PRODUCT MAKING IT UNSAFE

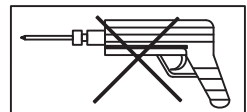

STEP 9

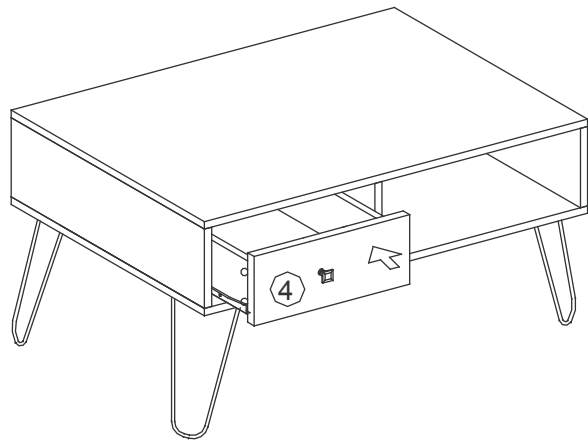

STEP 10

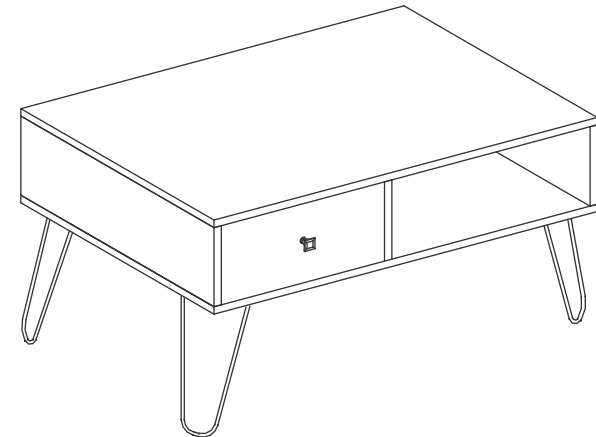

THE USE OF POWER TOOLS TO ASSEMBLE THIS PRODUCT WILL INVALIDATE ANY CLAIM AND ANY DAMAGE THIS PRODUCT MAKING IT UNSAFE

