

ASSEMBLING & INSTALLATION INSTRUCTIONS

WARNING! SHUT POWER OFF AT FUSE OR CIRCUIT BREAKER .

MOUNTING THE FIXTURE

Installation (see fig.1)

- 1.Disconnect power at main electrical panel before installation.
- 2.Mount the back plate to the wall with the plastic anchors(A) , the wood screw (D) and the two box screw (E). The side of the back plate marked "GND" must face out.
- 3.Guide fixture wires through hole in center of back plate.
- 4.Follow wiring instructions carefully (see fig.2)
- 5.Place the fixture body (F) over the back plate so that the back plate studs protrude through the cover plate holes and screw ball nuts (J) onto the long screws (C).
6. Raise the glass shade(H) to bottom of the lamp socket(G), and using the ring(I) by turning it clockwise until tight.
- 7.Install the light bulbs in accordance with the fixture's specifications. **DO NOT EXCEED THE MAXIMUM WATTAGE RATING!**

Wiring (see fig.2)

- 1.Connect the electrical wires as follows. Connect the Black wire from the fixture to the black house (hot) Wire. Connect the white wire from the fixture to the white (neutral) house wire. Make sure all wire nuts are secured. You may wrap the connections with electrical tape. If your outlet box has a ground wire (green or bare copper) connect fixture's ground wire to it. Otherwise attach the bare copper fixture wire to the green ground screw on the circular strap.
- 2.Tuck the wire connections neatly into the wall junction box.

Fig.1

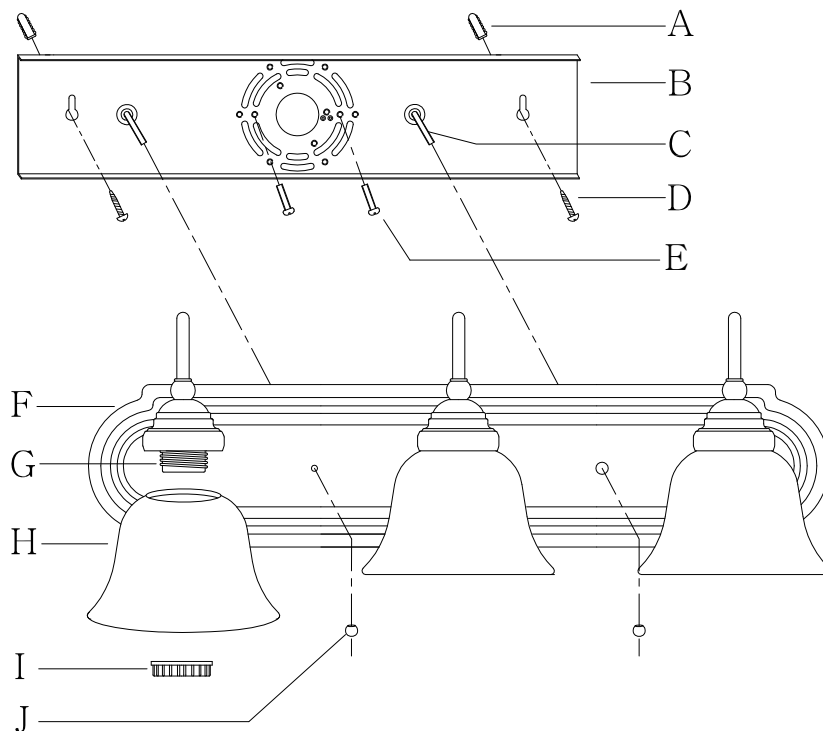



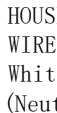



Fig.2

<p>FIXTURE WIRES</p> <p>Black or Smooth</p> 	<p>FIXTURE WIRES</p> <p>White or Ribbed</p> 	<p>FIXTURE WIRES</p> <p>Bare Copper (Ground)</p> 	<p>HOUSE WIRES</p> <p>Black (Hot)</p> 	<p>HOUSE WIRES</p> <p>White (Neutral)</p> 	<p>HOUSE WIRES</p> <p>Green or Bare Copper (Ground)</p> 
---	---	--	---	---	---