

7/8" DRAPERY ROD INSTALLATION INSTRUCTIONS - 36-72" ROD SET

Care Instructions: Clean with a soft cloth. Do not use abrasive cleaning agents, solvents or polishes.

SET INCLUDES:

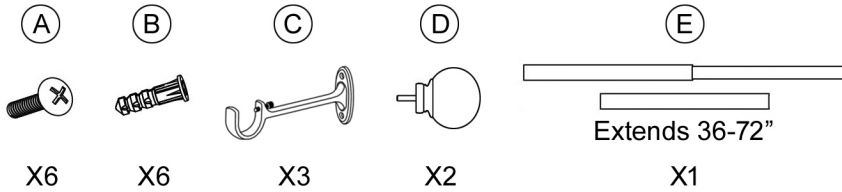

YOU WILL NEED:

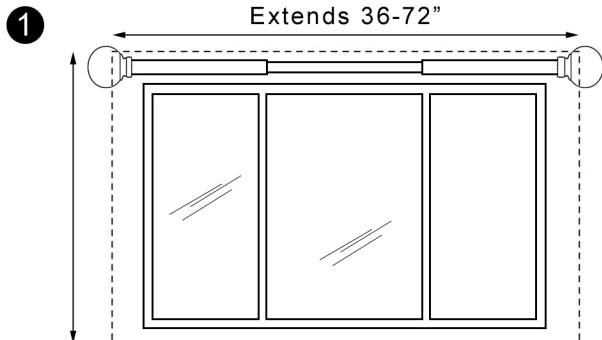
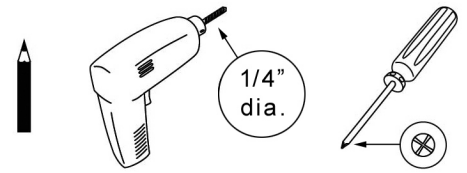

Before installation, measure windows to determine appropriate drapery rod length.

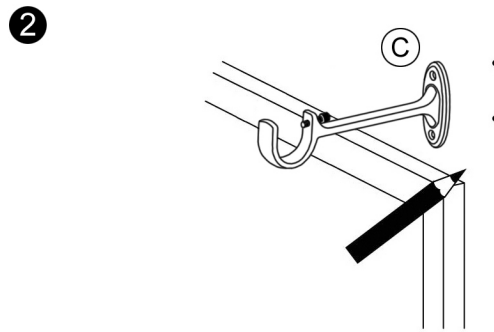

Use bracket (C) as a guide to mark location for mounting screws (A).

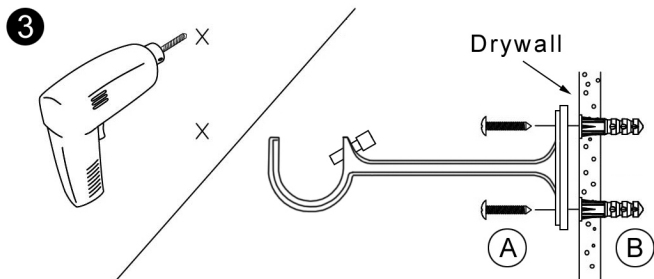

Drill pilot holes into wall with 1/4" drill bit (not included). Insert wall anchors (B) and attach bracket (C) using mounting screws (A). Wall anchors may not be necessary if drilling into studs.

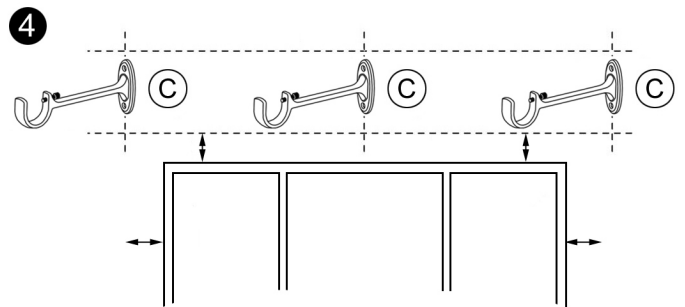

Repeat steps 2-3 for additional brackets. Use level if necessary.

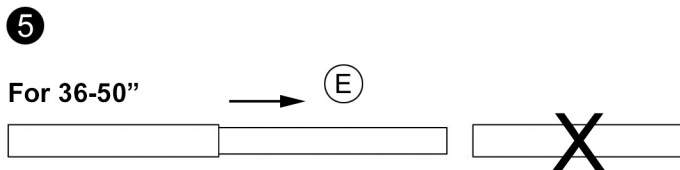

Use 2 telescopic rod sections (1 larger diam. and 1 smaller diam.).

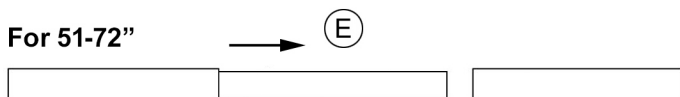

Use 3 telescopic rod sections. Extend the smaller diam. rod that is nested in the larger diam. rod. Then insert the smaller diam. center rod into the second larger diam. rod section.

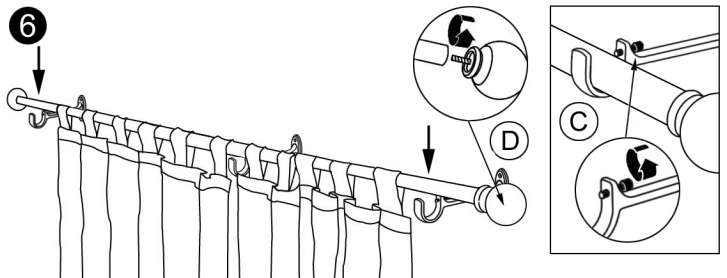

Place drapery panels (not included) onto drapery rod and extend to desired length. Hang rod on brackets. Screw finials (D) onto ends of rod and tighten set screws on brackets (C).