

PHOBOS 2 LIGHT WALL SCONCE

PRODUCT FEATURES

- Laser etched tubing to diffuse light surrounded by clear borosilicate glass
- This item is made of natural brass. It is a living finish that will patina and warm with age which adds richness. If it gets an uneven patina or spots, a brass cleaner can restore the finish
- Provides up and down light
- ADA Compliant
- Fully dimmable integrated LED lamp
- Protected by a 5-year warranty. Please visit the "About Us" Page on techlighting.com for more for warranty details



LAMPING

Includes 10.3 watt, 605 delivered lumens, 2700K LED module.
 Dimmable with most LED compatible ELV, TRIAC and 0-10V dimmers.
 Mounts vertically only. Up and downlight. 120V-277V.

Natural Brass (Lit)



ORDERING INFORMATION

700WSPHB LENGTH (A)	FINISH	LAMP
33.33"	BZ DARK BRONZE NB NATURAL BRASS N POLISHED NICKEL	-LED927 INTEGRATED LED 90 CRI 2700K 120V-277V UNV

700WSPHB _____

JOB NAME _____

NOTES _____



PHOBOS 2 LIGHT WALL SCONCE



SPECIFICATIONS

PRIMARY MATERIAL	Brass
SHADE MATERIAL	Glass
NET WEIGHT	3.5 lbs
HEIGHT	31.5in
WIDTH	2.6in
LENGTH	2.5in
MIN. EXTENSION FROM WALL	2.6in
UP LIGHT / DOWN LIGHT / BOTH?	
WET LISTED	
DAMP LISTED	Yes
DRY LISTED	
UP / DOWN	
HORIZONTAL / VERTICAL	
WALL / CEILING MOUNT	
GENERAL LISTING	ETL Listed
ADA COMPLIANT	
INCLUDES	

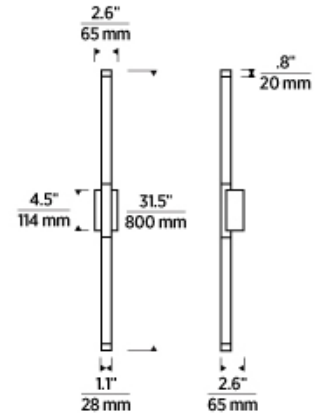

LAMPING SPECIFICATIONS

	LED LAMP	INTEGRATED LED	NON LED	NO LAMP
DELIVERED LUMENS		605		
WATTS		10.3		
MAX WATTAGE PER BULB		10.3W		
INPUT VOLTAGE/ DIMMING TYPE		Universal 120V-277V 0-10, ELV, TRIAC		
CCT		2700K		
CRI		90 CRI		
LED LIFETIME				
L70		>50000		
AVERAGE BULB HOURS				
FIELD SERVICEABLE LED				
LAMP BASE		Integrated LED		
LAMP SHAPE		Integrated LED		
LAMP INCLUDED?		True		
WARRANTY**		5 Years		

* Dimming information available at www.techlighting.com/Downloads#dimming

** Visit techlighting.com for specific warranty limitations and details.

T20 / T24 / JA8 INFORMATION

	Integrated LED	Replacement LED Lamp	No Lamp *
This product can be used to comply with California Building Energy Efficiency Standards 2016 Title 24 Part 6 / JA8.	Yes		
This product can be used to comply with California Appliance Efficiency Standards 2016 Title 20 and may be shipped to and sold in California.	N/A		

* If a light fixture or component does not include a lamp or light source, it is the responsibility of the customer to select a lamp that meets the T24 and T20 requirements.

